



ASIA INDUSTRIAL SUPPLIES

JTE ASIA INDUSTRIAL SUPPLIES SDN BHD - 1292683-X
No. 117 Jalan Glasiar , Taman Tasek,
80200 Johor Bahru , Johor, Malaysia

Tel: +607-2325399

Fax: +607-2325799

Whatapps : +6019-7556399

E-mail: sales@jteasia.com

Web: www.jteasia.com

New Products...



P136



P216



P178



P147



P104



P119



P78



MALAYSIA EDITION 3

TEMO[®]

INDUSTRIAL SUPPLIES

Products & Solutions

TEMO[®]

INDUSTRIAL SUPPLIES

MALAYSIA EDITION 3



www.temomalaysia.com

TEMO[®]

We are serving...

Precision Manufacturing



Aerospace



High-Speed Rail



Electric Vehicle



Mining

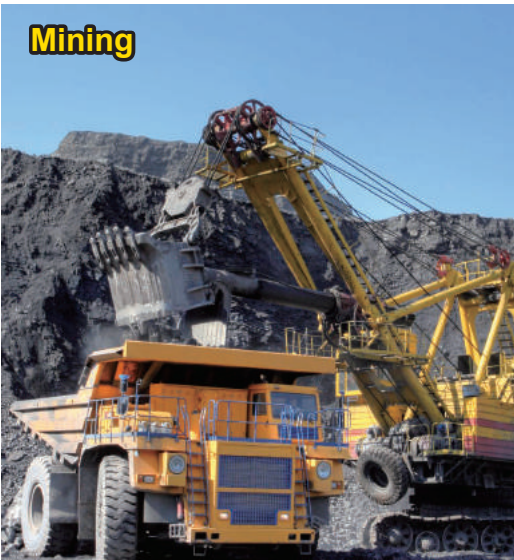

Military Manufacturing



Medical Instruments



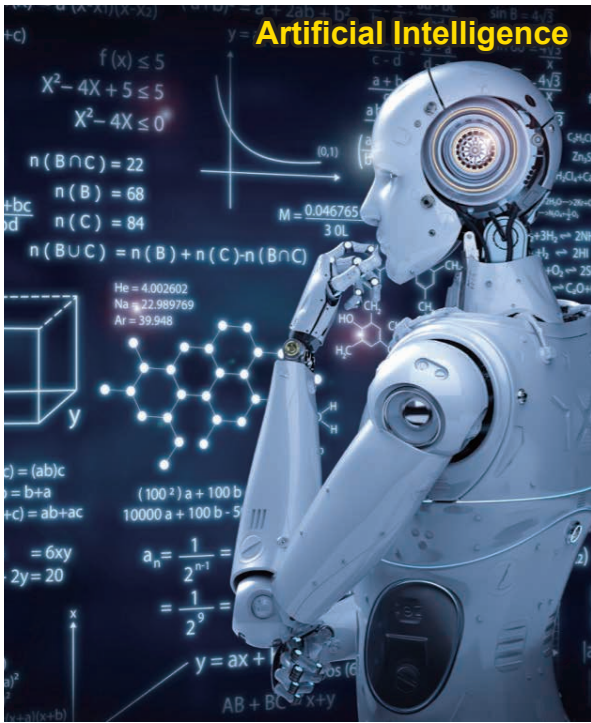
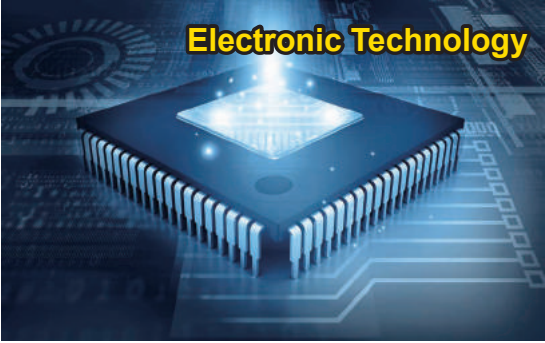



TEMO[®]

Customized for Your Requirement Beyond Catalogue Contents

- *Years Experience*
- *Professional Technical Team*
- *Advanced Processing Equipment*
- *Quality and Reliable Material*
- *Perfect After-sale Service*

TEMO[®] *is always by your side.
We Listen, We Care, We Do !*

1) Cutting Tools

Page1~34



2) Abrasives

Page35~44



3) Measuring Tools

Page45~74



3) Measuring Tools

Page45~74



4) Workshop Equipment & Tools

Page75~110



5) Hydraulic Equipment & Tools

Page111~120



6) Hand Tools

Page121~202



6) Hand Tools

Page121~202



7) Others

Page203~222

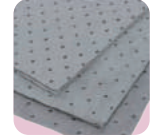
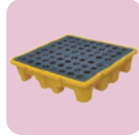
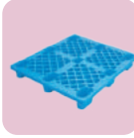

We are now satisfying our customers with...

TEMO[®]
INDUSTRIAL

***Professionals Choice &
Quality Assurance***

TEMO[®]
EXCELLENT

***Best Value for Exceptional
Performance***

TEMO[®]
EASYUSE

Reliability & Value for Money



TEMO®

Cutting Tools

www.temomalaysia.com

Carbide Burrs

Features



Using high-quality carbide materials,
High wear-resistance, Long life



High-quality diamond wheel
precision grinded fine edge
Sharp edge, bright finish



Round top with advanced partition
misplaced design cutting edge
to ensure effectively cut
all areas at the top











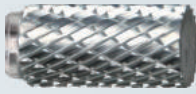
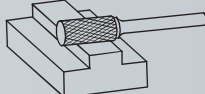
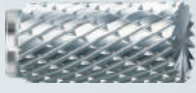
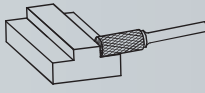

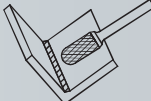

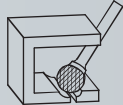
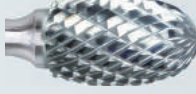
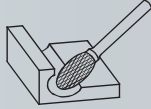
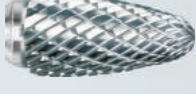
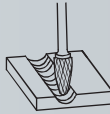

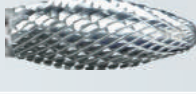

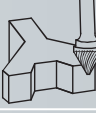
Elaborately designed geometry
cutting edge
Sharp and high efficiency cutting
performance, stable and smooth

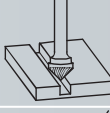
Tooth Types And Applications

Teeth Picture	Teeth Type	Code	Feature	Suitable for processing materials
	Diamond Cut	Q	Diamond-shaped tooth, chips flow like powder, produced smooth & clear surface finishing, easy control, suitable for high precision machining	Fiberglass reinforced plastic, carbon fiber reinforced plastic, thermoplastic, hard rubber, ceramic, HRC40-60 extra hardness steel, nickel-based alloy steel
	Aluma Cut	W	Aluma Cut W-Very large chip flute, very sharp cutting edge, fast chip flow, does not gather shavings	Aluminum, aluminum alloy, light metal, non-ferrous metal, plastic, hard rubber, wood
	Single Cut	P	Single Cut P common tooth type, elongated chips	Cast iron, cast steel, steel hardness less than HRC60, bronze, high-hard aluminum alloy, nickel-based alloy, stainless steel, titanium
	Double Cut	X	Universal tooth type, short chipping, after processing surface finish is better, smooth operation, easy to control	Cast iron, cast steel, steel hardness less than HRC60, nickel-based alloy, nickel-cobalt alloy, austenitic stainless steel, titanium

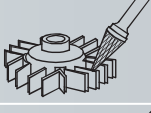
Types and Applications

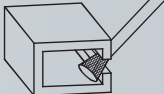
Style	Name	Letter Symbol	Application	Diagram
	Cylindrical plain end	A	Suitable for machining surface profiles	
	Cylindrical end cut	B	B is suitable for machining the surface profiles and two right-angled surfaces interchange	
	Cylindrical round head	C	C is suitable for machining surface contours and arc contours	
	Spherical	D	Ball D is suitable for machining and deburring on arc contours, caliber and the pre-welding areas	
	Oval	E	Oval E is suitable for machining arc contours	
	Arc round head	F	Round Tree F is suitable for machining arc contours at narrow places	
	Curved pointed	G	Pointed Tree G is suitable for machining arc contours and narrow places sharp angle contours	
	Torch shape	H	Flame H is suitable for machining arc contours	
	60° cone	J	60 ° Conical J For 60 ° countersinking and chamfering	
	90° cone	K	90 ° Conical K Suitable for 90 ° countersinking and chamfering	
	14° cone round head	L	L is suitable for processing the narrow outline and surface contour	
	Cone	M	M is suitable for processing the narrow outline and surface contour	
	Inverted Cone	N	Inverted Cone N is suitable for internal chamfering	

Selection and Application Guide

To achieve the best results, please follows below steps:

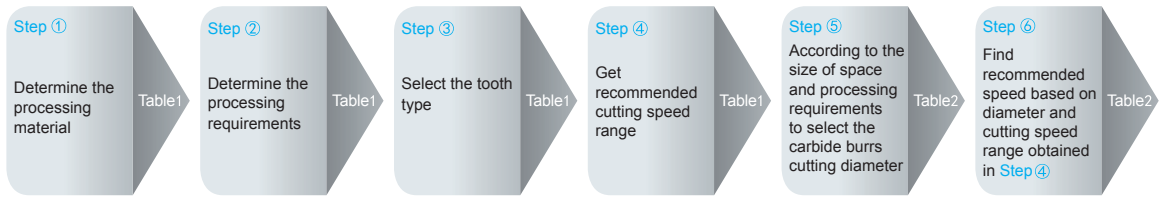

Table 1	① Machined Material	② Processing Requirements	③ Selection of Tooth Type	④ Cutting Speed
Steel and Cast Steel	Non-heat treatment steel hardness ≤ HRC40, Including structural steel, carbon steel, tool steel, non-alloy steel, cast steel	Roughing	Single cut (P)	450 - 600m/min
			Double cut (X)	450 - 600m/min
	Finishing	Single cut (P)	450 - 600m/min	
	Quenched and heat treated state hardness HRC40 - 55 Included tool steel, tempered steel, alloy steel, cast steel	Roughing	Single cut (P)	250 - 350m/min
		Double cut (X)	250 - 350m/min	
Stainless Steel	Austenitic stainless steel 301, 302, 303, 304, 304L, 316, 316L, 321, 317, etc., Ferrite Stainless Steel 409, 410L, 430, 439, 441, 434, 444, 446, 436, 445, 447 and the like	Roughing	Single cut (P)	250 - 350m/min
			Double cut (X)	250 - 350m/min
Non-ferrous Metals	Low-hardness non-ferrous metals include aluminum alloy, aluminum, brass, copper, zinc and so on	Finishing	Aluma cut (W)	800 - 900m/min
		Non-ferrous metals include bronze, titanium, titanium alloy, dull aluminum, etc	Roughing	Single cut (P)
			Double cut (X)	250 - 350m/min
	Finishing	Single cut (P)	350 - 450m/min	
Heat-resistant alloy steel such as nickel-based alloys, cobalt-based alloys (such as aircraft engine, turbine body, etc.)	Roughing	Single cut (P)	250 - 350m/min	
		Double cut (X)	250 - 350m/min	
Cast Iron	Gray iron, ductile iron and so on	Roughing	Double cut (X)	450 - 600m/min
			Single cut (P)	450 - 600m/min
		Finishing	Single cut (P)	500 - 600m/min
Plastic and others material	Mainly include reinforced nylon, plastic, hot plastic, hard rubber	Roughing	Diamond cut (Q)	500 - 900m/min
		Finishing	Aluma cut (W)	500 - 900m/min
	Glass fiber reinforced plastic, carbon fiber reinforced plastic, ceramic	Roughing	Diamond cut (Q)	500 - 900m/min

Selection and Application Guide

⑤ Diameter	④ Recommended cutting speed (m / min)								
	250	300	350	400	450	500	600	900	1100
	⑥ Recommended speed (rpm)								
2mm	40,000	48,000	56,000	64,000	72,000	80,000	95,000	143,000	175,000
3mm	27,000	32,000	37,000	42,000	48,000	53,000	64,000	95,000	117,000
4mm	20,000	24,000	28,000	32,000	36,000	40,000	48,000	72,000	88,000
5mm	16,000	19,000	22,000	25,000	29,000	32,000	38,000	57,000	70,000
6mm	13,000	16,000	19,000	21,000	24,000	27,000	32,000	48,000	59,000
8mm	10,000	12,000	14,000	16,000	18,000	20,000	24,000	36,000	44,000
10mm	8,000	10,000	11,000	13,000	14,000	16,000	19,000	29,000	35,000
12mm	7,000	8,000	9,000	11,000	12,000	13,000	16,000	24,000	30,000
16mm	5,000	6,000	7,000	8,000	9,000	10,000	12,000	18,000	22,000
19mm	4,000	5,000	6,000	6,000	7,000	8,000	10,000	14,000	18,500
25mm	3,000	4,000	4,000	5,000	6,000	6,000	8,000	11,000	14,000

In order to further improve tool life and chip flow performance, we can choose the appropriate surface coating for different processing materials

Titanium Nitride Coating (TiN)



Cost-effective universal coating, can improve tool surface hardness and high temperature stability, reduce tool surface friction coefficient to enhance tool life. Suitable for steel, cast iron pieces machining

Titanium Carbonitride Coating (TiCN)



Has a higher hardness and wear resistance coating than TiN and good adhesion & toughness, impact resistance, high temperature stability, suitable for processing ordinary steel, alloy steel, stainless steel and wear-resistant cast iron and other materials

Titanium aluminum nitride coating (TiAlN)



High hardness and high wear-resistant coating, low conductivity of heat transfer, good chemical stability, anti-oxidation & wear performance, suitable for high-speed cutting in heat-resistant alloy, alloy steel stainless steel, titanium, nickel alloy and so on

Diamond-like coating (DLC)



Has a high hardness, excellent wear resistance, low coefficient of friction significantly improve chip flow performance, great adhesion to substrate material & excellent corrosion resistance, especially suitable for processing aluminum and other non-ferrous metals

Special Aluma Cut Carbide Burrs

Precision grinding by Diamond grinding wheels, clear & smooth surface finishing, which is conducive to chip flow.

Unique knife-shaped design, sharp and light, no sticky debris

Arc-shaped large chip flute to allow fast chip flow, particularly suitable for machining aluminum and other soft sticky materials

High welding strength, resistance to bending & breaking, safe operation

High rigidity alloy steel handle, not easy to deform



Ultrafine grain carbide high strength, high wear-resistant



High precision turning, stable & smooth cutting

Large rake angle, sharp edge, fast cutting

Aluminum alloy processing DLC coating, high hardness, lubrication, corrosion-resistant, wear-resistant

Special Aluma Cut Cylindrical Ball Nose

- Suitable for aluminum alloy surface contouring and welding scars cleaning

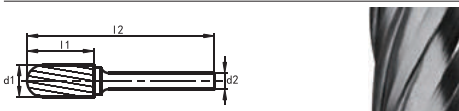

Size	Head Dia. (d1) mm	Head L. (l1) mm	Shank Dia. (d2) mm	Overall L. (l2) mm	Aluma cut Uncoated Order Code TMCB03	Price RM
C1020	10	20	6	65	-01020Z	148.60
C1225	12	25	6	70	-01225Z	215.00

5Pc DLC Coating Carbide Burr Set (Aviation Grade, 6mm Shank, Aluma Cut)

- 5pcs 6mm Shank Special Aluma Cut Set
- Suitable for aluminum alloy surface contouring applications
- high quality ABS plastic box packaging, stronger protection, lightweight and durable for easy storage and stacking



Size	Head Dia. (d1) mm	Head L. (l1) mm	Shank Dia. (d2) mm	Overall L. (l2) mm	Order Code TMCB88	Price RM
C1020	10	20	6	65	-20105Z	1130.50
C1225	12	25	6	70		
F0618	6	18	6	50		
F1020	10	20	6	65		
F1225	12	25	6	70		

ABS Plastic Box

Order Code	Size (mm)
TMCB00	
-01005B	145x105x40

Special Aluma Cut Round Tree

- Suitable for aluminum alloy slotted processing before welding, contouring and welding scars cleaning after vertical welding

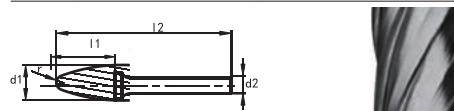

Size	Head Dia. (d1) mm	Head L. (l1) mm	Shank Dia. (d2) mm	Overall L. (l2) mm	Head R. (r) mm	Aluma cut Uncoated Order Code TMCB06	Price RM
F0618	6	18	6	56	1.6	-00618Z	146.60
F1020	10	20	6	65	2.4	-01020Z	140.70
F1225	12	25	6	70	3	-01225Z	176.00

Special Aluma Cut Conical Ball Nose

- Suitable for aluminum alloy surface contour, stenosis contour processing and welding scar cleaning after welding

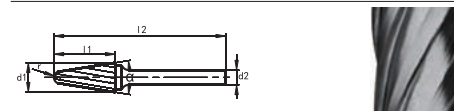

Size	Head Dia. (d1) mm	Head L. (l1) mm	Shank Dia. (d2) mm	Overall L. (l2) mm	Head R. (r) mm	Aluma cut Uncoated Order Code TMCB09	Price RM
L1636	16	36	6	75	4.8	-01636Z	291.50

Aluma Cut Cylindrical Plain End

- Suitable for milling surface contours

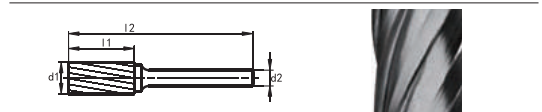

Size	Head Dia. (d1) mm	Head L. (l1) mm	Shank Dia. (d2) mm	Overall L. (l2) mm	Aluma cut Uncoated Order Code TMCB01	Price RM
3mm Shank Diameter						
A0314	3	14	3	38	-00314W	22.00
A0613	6	13	3	53	-00613W	32.70
6mm Shank Diameter						
A0618	6	18	6	56	-00618W	69.90
A0818	8	18	6	64	-00818W	69.90
A1020	10	20	6	65	-01020W	70.90
A1225	12	25	6	70	-01225W	102.50
A1625	16	25	6	70	-01625W	149.10
A1925	19	25	6	70	-01925W	199.70
8mm Shank Diameter						
A1225W08	12	25	8	70	-01228W	102.50

Aluma Cut Cylindrical Ball Nose

- Suitable for milling surface profiles and rounded corners

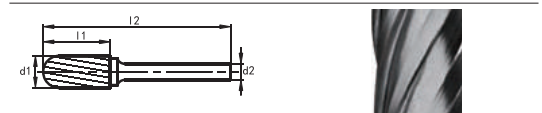

Size	Head Dia. (d1) mm	Head L. (l1) mm	Shank Dia. (d2) mm	Overall L. (l2) mm	Aluma cut Uncoated Order Code TMCB03	Price RM
3mm Shank Diameter						
C0314	3	14	3	38	-00314W	22.00
C0613	6	13	3	53	-00613W	32.70
6mm Shank Diameter						
C0618	6	18	6	56	-00618W	69.90
C0818	8	18	6	63	-00818W	69.90
C1020	10	20	6	65	-01020W	70.90
C1225	12	25	6	70	-01225W	102.50
C1625	16	25	6	70	-01625W	149.10
C1925	19	25	6	70	-01925W	199.70
8mm Shank Diameter						
C1225	12	25	8	70	-01228W	102.50

Aluma Cut Cylindrical-End Cutting

- Suitable for milling surface contours and two right-angle intersection

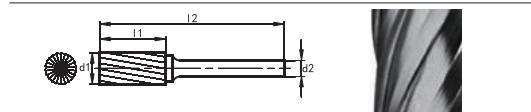

Size	Head Dia. (d1) mm	Head L. (l1) mm	Shank Dia. (d2) mm	Overall L. (l2) mm	Aluma cut Uncoated Order Code TMCB02	Price RM
3mm Shank Diameter						
B0314	3	14	3	38	-00314W	22.00
B0613	6	13	3	58	-00613W	32.70
6mm Shank Diameter						
B0618	6	18	6	56	-00618W	69.90
B0818	8	18	6	64	-00818W	57.60
B1020	10	20	6	65	-01020W	70.90
B1225	12	25	6	70	-01225W	102.50
B1625	16	25	6	70	-01625W	149.10
B1925	19	25	6	70	-01925W	199.70
8mm Shank Diameter						
B1225	12	25	8	70	-01228W	102.50

Aluma Cut Ball Shape

- Suitable for milling arc contour, burring at caliber area, pre-processing before welding

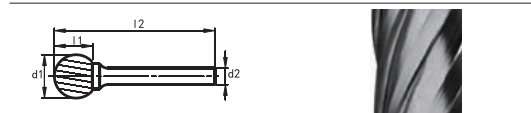

Size	Head Dia. (d1) mm	Head L. (l1) mm	Shank Dia. (d2) mm	Overall L. (l2) mm	Aluma cut Uncoated Order Code TMCB04	Price RM
3mm Shank Diameter						
D0303	3	2.8	3	38	-00303W	22.00
D0605	6	5.4	3	45	-00605W	29.80
6mm Shank Diameter						
D0605	6	5.4	6	56	-00606W	69.90
D0807	8	7.2	6	52	-00807W	69.90
D1009	10	9	6	53	-01009W	69.90
D1211	12	10.8	6	56	-01211W	85.90
D1614	16	14.4	6	59	-01614W	106.80
D1917	19	17.1	6	61	-01917W	186.50
8mm Shank Diameter						
D1211	12	10.8	8	56	-01218W	85.90

Aluma Cut Oval Shape

- Suitable for milling arc contour

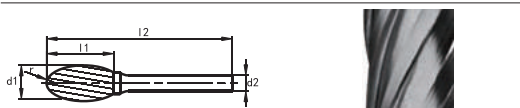

Size	Head Dia. (d1) mm	Head L. (l1) mm	Shank Dia. (d2) mm	Overall L. (l2) mm	Head R. (r) mm	Aluma cut Uncoated Order Code TMCB05	Price RM
6mm Shank Diameter							
E0610	6	10	6	56	2.4	-00610W	32.70
E0813	8	13	6	58	3.7	-00813W	69.20
E1016	10	16	6	61	4.0	-01016W	78.20
E1220	12	20	6	65	4.0	-01220W	100.80
E1625	16	25	6	70	6.3	-01625W	160.40
E1925	19	25	6	70	8.0	-01925W	219.60

Aluma Cut Conical Ball Nose

- Suitable for the narrow places milling and surface contouring

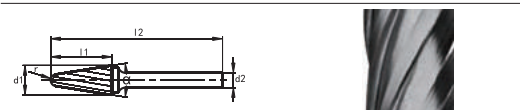

Size	Head Dia. (d1) mm	Head L. (l1) mm	Shank Dia. (d2) mm	Overall L. (l2) mm	Head R. (r) mm	Aluma cut Uncoated Order Code TMCB09	Price RM
6mm Shank Diameter							
L0616	6	16	6	56	1.2	-00616W	69.90
L0822	8	22	6	67	1.4	-00822W	61.50
L1027	10	27	6	72	1.6	-01027W	70.90
L1230	12	30	6	75	3.2	-01230W	100.80
L1630	16	30	6	75	4.8	-01630W	139.90
L1938	19	38	6	83	5.6	-01938W	211.80
8mm Shank Diameter							
L1230	12	30	8	75	3.2	-01238W	100.80
L1630	16	30	8	75	4.8	-01638W	139.90



Aluma Cut Round Tree

- Suitable for milling arc contour at the narrow places

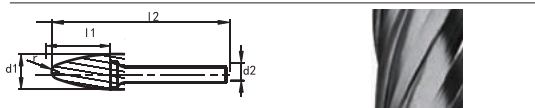

Size	Head Dia. (d1) mm	Head L. (l1) mm	Shank Dia. (d2) mm	Overall L. (l2) mm	Head R. (r) mm	Aluma cut Uncoated Order Code TMCB06	Price RM
3mm Shank Diameter							
F0313	3	13	3	38	0.9	-00313W	22.00
F0613	6	13	3	53	1.6	-00613W	32.70
6mm Shank Diameter							
F0618	6	18	6	56	1.6	-00618W	69.90
F0818	8	18	6	63	1.8	-00818W	69.90
F1020	10	20	6	65	2.4	-01020W	70.00
F1225	12	25	6	70	3	-01225W	83.90
F1625	16	25	6	70	3.5	-01625W	126.70
F1925	19	25	6	70	4.7	-01925W	199.70
8mm Shank Diameter							
F1225	12	25	8	70	3	-01228W	83.90

5Pc Carbide Burr Set (6mm Shank, Aluma Cut)

- 5pcs 6mm Shank Aluma Cut with combination of common type
- Suitable for aluminum alloy surface contouring
- High quality ABS plastic box packaging, stronger protection, lightweight and durable for easy storage and stacking



Size	Head Dia. (d1) mm	Head L. (l1) mm	Shank Dia. (d2) mm	Overall L. (l2) mm	Order Code TMCB88	Price RM
C1020	10	20	6	65	-00105W	543.50
C1225	12	25	6	70		
F0618	6	18	6	50		
F1020	10	20	6	65		
F1225	12	25	6	70		

ABS Plastic Box

Order Code TMCB00	Size (mm)
-01005B	145x105x40



**General Series
- Cylindrical Plain End**

- Suitable for machining surface profiles

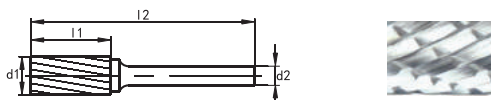

Size	Head Dia. (d1) mm	Head L. (l1) mm	Shank Dia. (d2) mm	Overall L. (l2) mm	Double Gear (X) Order Code	Price RM
3mm Shank Diameter						
A0314	3	14	3	38	-40314X	22.00
A0613	6	13	3	53	-40613X	29.00
6mm Shank Diameter						
A0616	6	16	6	50	-40616X	61.80
A0819	8	19	6	64	-40819X	51.00
A1020	10	20	6	65	-50102X	62.70
A1225	12	25	6	70	-50122X	90.70
A1625	16	25	6	70	-50162X	132.00
A1925	19	25	6	70	-50192X	173.20
8mm Shank Diameter						
A1225	12	25	8	70	-50128X	90.70

**General Series
- Cylindrical Ball Nose**

- Suitable for milling surface profiles and rounded corners

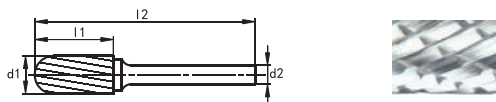

Size	Head Dia. (d1) mm	Head L. (l1) mm	Shank Dia. (d2) mm	Overall L. (l2) mm	Double Gear (X) Order Code	Price RM
3mm Shank Diameter						
C0314	3	14	3	38	-40314X	22.00
C0613	6	13	3	53	-40613X	29.00
6mm Shank Diameter						
C0616	6	16	6	50	-40616X	61.80
C0819	8	19	6	64	-40819X	51.00
C1020	10	20	6	65	-50102X	62.70
C1225	12	25	6	70	-50122X	90.70
C1625	16	25	6	70	-50162X	132.00
C1925	19	25	6	70	-50192X	176.80
8mm Shank Diameter						
C1225	12	25	8	70	-50128X	90.70

**General Series
- Cylindrical-End Cutting**

- Suitable for milling surface contours and two right-angle intersection

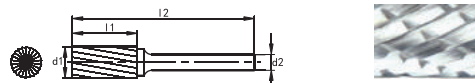

Size	Head Dia. (d1) mm	Head L. (l1) mm	Shank Dia. (d2) mm	Overall L. (l2) mm	Double Gear (X) Order Code	Price RM
3mm Shank Diameter						
B0314	3	14	3	38	-40314X	22.00
B0613	6	13	3	53	-40613X	29.00
6mm Shank Diameter						
B0619	6	19	6	50	-40619X	61.80
B0819	8	19	6	64	-40819X	51.00
B1020	10	20	6	65	-50102X	62.70
B1225	12	25	6	70	-50122X	90.70
B1625	16	25	6	70	-50162X	132.00
B1925	19	25	6	70	-50192X	176.80
8mm Shank Diameter						
B1225	12	25	8	70	-50128X	90.70

General Series - Ball Shape

- Suitable for machining arc contours, deburring at caliber area and pre-machining before port welding
- For ordinary steel, alloy steel, welding spot grinding

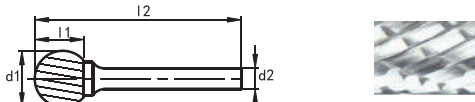

Size	Head Dia. (d1) mm	Head L. (l1) mm	Shank Dia. (d2) mm	Overall L. (l2) mm	Double Gear (X) Order Code	Price RM
3mm Shank Diameter						
D0303	3	2.7	3	38	-40303X	22.00
D0504	5	4.5	3	44	-40504X	26.20
6mm Shank Diameter						
D0605	6	5.4	6	50	-40605X	61.80
D0807	8	7.2	6	52	-40807X	44.20
D1009	10	9	6	54	-50109X	49.40
D121	12	10.8	6	56	-50121X	75.90
D1614	16	14.4	6	59	-50161X	94.60
D1916	19	17.1	6	61	-50191X	165.00
8mm Shank Diameter						
D121	12	10.8	8	56	-50128X	75.90

General Series - Oval Shape

- Suitable for machining surface and rounded corner profiles

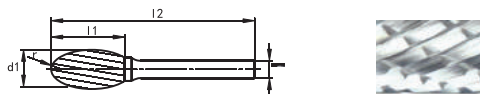

Size	Head Dia. (d1) mm	Head L. (l1) mm	Shank Dia. (d2) mm	Overall L. (l2) mm	Head R. (r) mm	Double Gear (X) Order Code TMCB05	Price RM
3mm Shank Diameter							
E0306	3	6	3	38	1.2	-40306X	22.00
E0609	6	9	3	50	2.4	-40609X	29.00
6mm Shank Diameter							
E0610	6	10	6	50	2.4	-40610X	61.80
E0813	8	13	6	58	3.7	-40813X	61.30
E1016	10	16	6	61	4.0	-50101X	69.30
E1220	12	20	6	65	4.0	-50122X	89.30
E1625	16	25	6	70	6.3	-50162X	141.90
E1925	19	25	6	70	8.0	-50192X	197.30
8mm Shank Diameter							
E1220	12	20	8	65	4.0	-50128X	89.30

General Series - Round Tree

- Suitable for narrow places arc contour milling

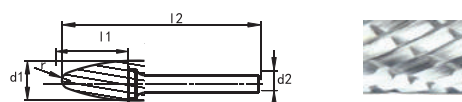

Size	Head Dia. (d1) mm	Head L. (l1) mm	Shank Dia. (d2) mm	Overall L. (l2) mm	Head R. (r) mm	Double Gear (X) Order Code TMCB06	Price RM
3mm Shank Diameter							
F0313	3	13	3	38	0.6	-40313X	22.00
F0613	6	13	3	53	1.6	-40613X	29.00
6mm Shank Diameter							
F0618	6	18	6	50	1.6	-40618X	61.80
F0818	8	18	6	63	1.8	-40818X	57.90
F1020	10	20	6	65	2.4	-50102X	59.40
F1225	12	25	6	70	3.0	-50122X	74.30
F1325	12.7	25	6	70	3.2	-50132X	80.00
F1625	16	25	6	70	3.5	-50162X	112.20
F1925	19	25	6	70	4.7	-50192X	176.80
8mm Shank Diameter							
F1225	12	25	8	70	3.0	-50128X	74.30
F1625	16	25	8	70	3.5	-50168X	112.20

General Series - Pointed Tree

- Suitable for processing the arc contour of narrow area and the contour of sharp angle

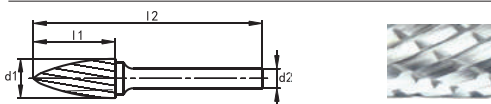

Size	Head Dia. (d1) mm	Head L. (l1) mm	Shank Dia. (d2) mm	Overall L. (l2) mm	Head R. (r) mm	Double Gear (X) Order Code TMCB07	Price RM
3mm Shank Diameter							
G0313	3	13	3	38		-40313X	22.00
G0613	6	13	3	53		-40613X	29.00
6mm Shank Diameter							
G0618	6	18	6	50		-40618X	61.80
G0818	8	18	6	63		-40818X	59.50
G1020	10	20	6	65		-50102X	59.50
G1225	12	25	6	70		-50122X	62.70
G1625	16	25	6	70		-50162X	81.20
G1925	19	25	6	70		-50192X	121.10
8mm Shank Diameter							
G1225	12	25	8	70		-50128X	81.20

General Series - Flame Shape

- Suitable for machining arc contours
- For ordinary steel, alloy steel, welding spot grinding

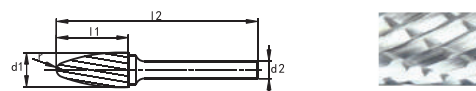

Size	Head Dia. (d1) mm	Head L. (l1) mm	Shank Dia. (d2) mm	Overall L. (l2) mm	Head R. (r) mm	Double Gear (X) Order Code TMCB08	Price RM
3mm Shank Diameter							
H0307	3	7	3	38	0.8	-40307X	22.00
6mm Shank Diameter							
H0618	6	18	6	50	1.0	-40618X	61.80
H0819	8	19	6	64	1.6	-40819X	61.30
H1025	10	25	6	70	2.0	-50102X	69.30
H1232	12	32	6	77	2.4	-50123X	89.30
H1636	16	36	6	81	3.0	-50163X	141.90
H1941	19	41	6	86	4.0	-50194X	208.70

General Series - Conical Ball Nose

- Suitable for processing the outline of the narrow area and surface contour
- For ordinary steel, alloy steel, welding spot grinding

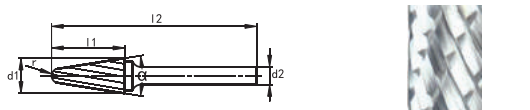

Size	Head Dia. (d1) mm	Head L. (l1) mm	Overall L. (l2) mm	Head R. (r) mm	Angle (α)	Double Gear (X) Order Code TMCB09	Price RM
3mm Shank Diameter							
L0313	3	13	38	0.6	8°	-40313X	22.00
L0619	6	19	59	1.2	14°	-40619X	34.50
6mm Shank Diameter							
L0616	6	16	50	1.2	14°	-40616X	61.80
L0822	8	22	67	1.4	14°	-40822X	54.40
L1027	10	27	72	1.6	14°	-50102X	62.70
L1230	12	30	75	3.2	14°	-50123X	89.30
L1630	16	30	75	4.8	14°	-50163X	123.80
L1938	19	38	83	5.6	14°	-50193X	187.50
8mm Shank Diameter							
L1230	12	30	75	3.2	14°	-50128X	89.30

General Series - Conical

- Suitable for processing the outline of the narrow area and surface contour

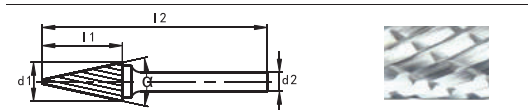

Size	Head Dia. (d1) mm	Head L. (l1) mm	Shank Dia. (d2) mm	Overall L. (l2) mm	Angle (α)	Double Gear (X) Order Code TMCB10	Price RM
3mm Shank Diameter							
M0311	3	11	3	38	14°	-40311X	22.00
M0613	6	13	3	53	22°	-40613X	29.00
6mm Shank Diameter							
M0618	6	18	6	50	14°	-40618X	61.80
M0820	8	20	6	65	28°	-40820X	56.10
M1020	10	20	6	65	25°	-50102X	66.00
M1225	12	25	6	70	25°	-50122X	68.00
M1625	16	25	6	70	31°	-50163X	115.60
8mm Shank Diameter							
M1225	12	25	8	70	25°	-50128X	78.20

General Series - Conical 60°



- Suitable for countersinking and chamfering



Size	Head Dia. (d1) mm	Head L. (l1) mm	Shank Dia. (d2) mm	Overall L. (l2) mm	Angle (α)	Double Gear (X) Order Code TMCB11	Price RM
3mm Shank Diameter							
J03x2	3	2.5	3	38	60°	-40325X	22.00
6mm Shank Diameter							
J0604	6	4	6	50	60°	-40604X	56.40
J0807	8	7	6	52	60°	-40807X	47.60
J1008	10	8	6	58	60°	-50108X	52.80
J1210	12	10	6	60	60°	-50121X	68.00
J1614	16	14	6	64	60°	-50161X	106.00
J1916	19	16	6	66	60°	-50191X	176.80

General Series - Conical 90°



- Suitable for countersinking and chamfering



Size	Head Dia. (d1) mm	Head L. (l1) mm	Shank Dia. (d2) mm	Overall L. (l2) mm	Angle (α)	Double Gear (X) Order Code TMCB12	Price RM
3mm Shank Diameter							
K0302	3	2	3	38	90°	-40302X	22.00
6mm Shank Diameter							
K0603	6	3	6	50	90°	-40603X	61.80
K0804	8	4	6	54	90°	-40804X	47.60
K1005	10	5	6	55	90°	-50105X	52.80
K1206	12	6	6	56	90°	-50126X	68.00
K1608	16	8	6	58	90°	-50168X	106.00
K1910	19	10	6	60	90°	-50191X	176.80

General Series - Inverted Cone



- Suitable for inside chamfering



Size	Head Dia. (d1) mm	Head L. (l1) mm	Shank Dia. (d2) mm	Overall L. (l2) mm	Angle (α)	Double Gear (X) Order Code TMCB13	Price RM
3mm Shank Diameter							
N0303	3	3	3	38	10°	-40303X	22.00
N0606	6	6	3	46	10°	-40606X	29.00
6mm Shank Diameter							
N0608	6	8	6	50	10°	-40608X	56.40
N1010	10	10	6	55	13°	-50101X	57.80
N1313	13	13	6	58	28°	-50131X	69.30
N1619	16	19	6	64	18°	-50161X	106.00
N1916	19	16	6	61	30°	-50191X	176.80

Long Shank Carbide Burrs

- Can reach into the small space for processing
- Excellent handle rigidity, not easily deformed
- High accuracy slewing, smooth and efficient processing
- When using the long shank rotation, should be appropriately reduced speed, see the table on the right
- In order to ensure safety, the tool should extend into and touch the workpiece then only turn on the machine.

When the machine is turned on, keep the tool in contact with the workpiece until the machine is turned off

- Cutting type, diameter and length, handle diameter and length can be customized



Head Dia. (mm)	3			6		8	10	12
Total L. (mm)	50	75	150	90	150	150	150	150
Recommend Rotating Speed (rpm)	35000	31000	25000	18000	15000	12000	11000	7000

Long Shank Series - Cylindrical Plain End

- Suitable for extending into the deep area for surface contours processing



Size	Head Dia. (d1) mm	Head L. (l1) mm	Shank Dia. (d2) mm	Overall L. (l2) mm	Double Gear (X) Order Code TMCB01	Price RM
3mm Shank Diameter						
A0314	3	14	3	50	-60314X	22.50
A0314	3	14	3	75	-60315X	27.00
A0314	3	14	3	150	-60316X	39.30
A0613	6	13	3	88	-60613X	29.00
6mm Shank Diameter						
A0618	6	18	6	150	-60618X	69.90
A0818	8	18	6	150	-60818X	57.80
A1020	10	20	6	150	-70102X	62.70
A1225	12	25	6	150	-70122X	90.70

Long Shank Series - Cylindrical Ball Nose

- Suitable for extending into the deep area for surface contours and arc contours processing

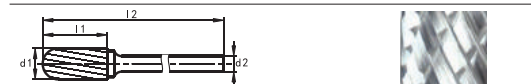

Size	Head Dia. (d1) mm	Head L. (l1) mm	Shank Dia. (d2) mm	Overall L. (l2) mm	Double Gear (X) Order Code TMCB03	Price RM
3mm Shank Diameter						
C0314	3	14	3	50	-60314X	22.50
C0314	3	14	3	75	-60315X	27.00
C0314	3	14	3	150	-60316X	39.30
C0613	6	13	3	88	-60613X	29.00
6mm Shank Diameter						
C0618	6	18	6	150	-60618X	69.90
C1020	10	20	6	150	-70102X	89.20
C1225	12	25	6	150	-70122X	105.40

Long Shank Series - Ball

- Suitable for reaching into the deep area for processing arc profile, caliber deburring and welding pre-processing

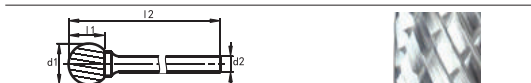

Size	Head Dia. (d1) mm	Head L. (l1) mm	Shank Dia. (d2) mm	Overall L. (l2) mm	Double Gear (X) Order Code TMCB04	Price RM
3mm Shank Diameter						
D0303	3	2.8	3	50	-60303X	22.50
D0303	3	2.8	3	75	-60304X	27.00
D0303	3	2.8	3	150	-60305X	39.30
D0605	6	5.4	3	88	-60605X	61.80
6mm Shank Diameter						
D0605	6	5.4	6	150	-60606X	60.90
D0807	8	7.2	6	150	-60807X	44.20
D1009	10	9	6	150	-70109X	49.40
D1211	12	10.8	6	150	-70121X	85.90

Long Shank Series - Oval

- Suitable for extending into the deep area for processing of arc contour



Size	Head Dia. (d1) mm	Head L. (l1) mm	Shank Dia. (d2) mm	Overall L. (l2) mm	Head R. (r) mm	Double Gear (X) Order Code TMCB05	Price RM
3mm Shank Diameter							
E0306	3	7	3	50	1.2	-60307X	22.50
E0306	3	7	3	75	1.2	-60308X	27.00
E0306	3	7	3	150	1.2	-60309X	39.30
E0610	6	10	3	85	2.4	-60610X	28.30
6mm Shank Diameter							
E0610	6	10	6	150	2.4	-60611X	61.80
E0813	8	13	6	150	3.7	-60813X	61.30
E1016	10	16	6	150	4.0	-70101X	69.30
E1220	12	20	6	150	4.0	-70122X	89.30

Long Shank Series - Round Tree

- Suitable for extending into the deep & narrow area for processing of the arc contour

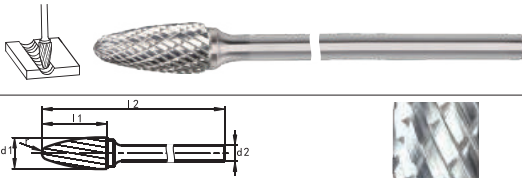

Size	Head Dia. (d1) mm	Head L. (l1) mm	Shank Dia. (d2) mm	Overall L. (l2) mm	Head R. (r) mm	Double Gear (X) Order Code TMCB06	Price RM
3mm Shank Diameter							
F0313	3	13	3	50	0.9	-60313X	22.50
F0313	3	13	3	75	0.9	-60314X	27.00
F0313	3	13	3	150	0.9	-60315X	39.30
F0613	6	13	3	88	1.6	-60613X	29.00
6mm Shank Diameter							
F0618	6	18	6	150	1.6	-60618X	61.80
F0818	8	18	6	150	1.8	-60818X	57.90
F1020	10	20	6	150	2.4	-70102X	59.40
F1225	12	25	6	150	3.0	-70122X	74.30

Long Shank Series - Flame

- Suitable for reaching into deep area for processing of arc contour

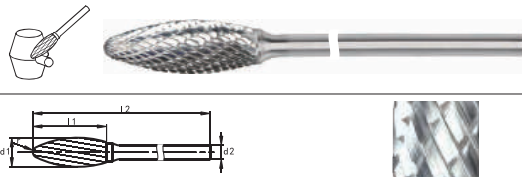

Size	Head Dia. (d1) mm	Head L. (l1) mm	Shank Dia. (d2) mm	Overall L. (l2) mm	Head R. (r) mm	Double Gear (X) Order Code TMCB08	Price RM
3mm Shank Diameter							
H0313	3	13	3	50	0.8	-60313X	22.50
H0313	3	13	3	75	0.8	-60314X	27.00
6mm Shank Diameter							
H0618	6	18	6	150	1.0	-60618X	24.20
H0820	8	20	6	150	1.6	-60820X	58.90
H1232	12	32	6	150	2.4	-70123X	89.30

Special Series - Internal Trimming Burrs

- For inside rounded corners chamfering

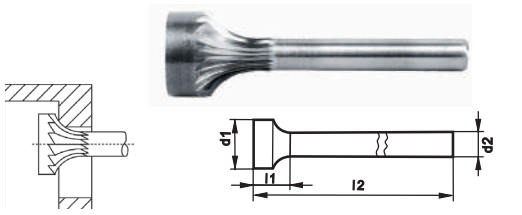

Size	Head Dia. (d1) mm	Head L. (l1) mm	Shank Dia. (d2) mm	Overall L. (l2) mm	Order Code TMCB30	Price RM
S1618P06T120	16	18	6	120	-01618P	174.90
S2218P08T120	22	18	8	120	-02218P	233.20

Long Shank Series - Pointed Tree

- Suitable for reaching into deep area for processing of the narrow arc at the contour and sharp angle contour

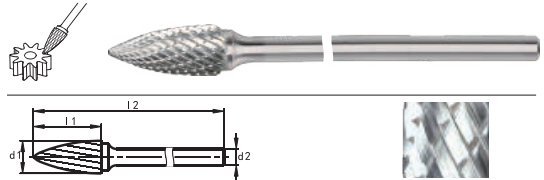

Size	Head Dia. (d1) mm	Head L. (l1) mm	Shank Dia. (d2) mm	Overall L. (l2) mm	Double Gear (X) Order Code TMCB07	Price RM
3mm Shank Diameter						
G0313	3	13	3	50	-60313X	22.50
G0313	3	13	3	75	-60314X	27.00
G0313	3	13	3	150	-60315X	39.30
G0613	6	13	3	88	-60613X	29.00
6mm Shank Diameter						
G0618	6	18	6	150	-60618X	61.80
G1020	10	20	6	150	-70102X	59.50
G1225	12	25	6	150	-70122X	62.70

Long Shank Series - Conical Ball Nose

- Suitable for reaching into deep area for processing of narrow at the contour and surface contour

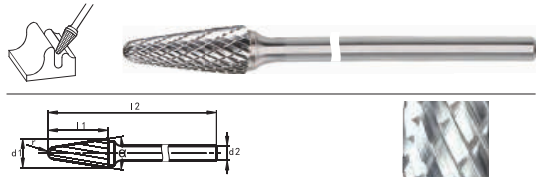

Size	Head Dia. (d1) mm	Head L. (l1) mm	Shank Dia. (d2) mm	Overall L. (l2) mm	Head R. (r) mm	Double Gear (X) Order Code TMCB09	Price RM
3mm Shank Diameter							
L0313	3	13	3	50	0.6	-60313X	22.50
L0313	3	13	3	75	0.6	-60314X	27.00
L0313	3	13	3	150	0.6	-60315X	39.30
6mm Shank Diameter							
L0616	6	16	6	150	1.2	-60616X	61.80
L1027	10	27	6	150	1.6	-70102X	62.70
L1230	12	30	6	150	3.2	-70122X	89.30

Special Series - External Trimming Burrs

- For outside rounded corners chamfering

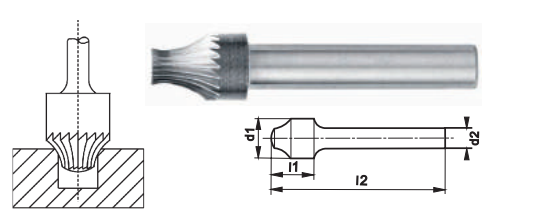

Size	Head Dia. (d1) mm	Head L. (l1) mm	Shank Dia. (d2) mm	Overall L. (l2) mm	Order Code TMCB31	Price RM
R1015P06T55	10	15	6	55	-01015P	70.00
R1215P08T55	12	15	8	55	-01215P	102.10

Special Series - Fiberglass Routers

- For fiberglass reinforced plastics, carbon fiber reinforced plastics, thermoplastic and hard rubber materials modification and contouring milling
- Multi-end tooth profile for face milling
- Drill type for drilling, milling
- Flat type for edge trimming, milling
- Recommended speed: 20000-36000rpm



Size	Head Dia.		Head L.		Shank Dia.		Shank L.		Multi-end Tooth		Drill Type		Flat Type	
	(d1)	(l1)	(d2)	(l2)	(d1)	(l1)	(d2)	(l2)	Order Code	Price RM	Order Code	Price RM	Order Code	Price RM
P0313Q0340	3	13	3	40	-00313Q	26.80	-00313D	26.80	-00313E	26.80	Order Code	Price RM	Order Code	Price RM
P0620Q06150	6	20	6	50	-00620Q	59.20	-00620D	59.20	-00620E	59.20	Order Code	Price RM	Order Code	Price RM
P0825Q08180	8	25	8	80	-00825Q	102.40	-00825D	102.40	-00825E	102.40	Order Code	Price RM	Order Code	Price RM
P1025Q10180	10	25	10	80	-01025Q	226.80	-01025D	226.80	-01025E	226.80	Order Code	Price RM	Order Code	Price RM
P1230Q12180	12	30	12	80	-01230Q	315.80	-01230D	315.80	-01230E	315.80	Order Code	Price RM	Order Code	Price RM

Special Series - Carbide Tyre Wire Cutters

- Suitable for tire repair, cutting the steel wire in the tire and cleaning the messy steel wire
- Especially suitable for large truck tire repair, can effectively extend the tire life, greatly reducing costs
- Suitable for mines, oil fields, military, aerospace, construction machinery, metallurgy and other areas of heavy industry
- Three plane handle clamps stonger than round handle, not slippery, can provide greater torque
- Use with pneumatic or electric tools
- Maximum speed of use: 500rpm

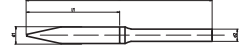

Size	Head Dia. (d1)	Head L. (l1)	Shank Dia. (d2)	Overall L. (l2)	Three-plane handle Order Code	Price RM
M0331X03165	3	31	3	65	-10331C	42.00
M0452X04175	4	52	4	75	-10452C	81.70
M0652X06180	6	52	6	80	-10652C	89.80
M0852X081100	8	52	8	100	-10852C	207.60
M1065X9.5T110	10	65	10	110	-11065C	212.30
M1378X9.5T125	13	78	10	125	-11378C	322.70

10Pc TiN Coated Carbide Burr Set (Aviation Grade, 6mm Shank, Double Cut)

- Heavy equipment and other professional industries
- High quality ABS plastic box packaging, stronger protection,
- Lightweight and durable, easy to place and stack

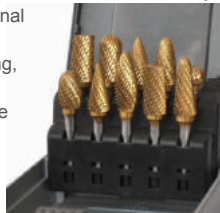

Size	Head Dia.	Head L.	Shank Dia.	Shank L.	Order Code	Price RM
A1225	12	25	6	70	-41010X	774.20
C0616	6	16	6	50		
C1225	12	25	6	70		
D1211	12	10.8	6	56		
D0605	6	5.4	6	50		
F0618	6	18	6	50		
G1225	12	25	6	70		
G0618	6	18	6	50		
L1230	12	30	6	75		
M0618	6	18	6	50		



ABS Plastic Box

Order Code	Size (mm)	Price RM
TMCB00		
-02010B	145x105x40	56.60

10Pc Carbide Burr Set (High Performance Grade, 6mm Shank, Double Cut)

- Dedicated to the shipbuilding, machinery manufacturing, locomotives manufacturing and other industrial areas
- High quality ABS plastic box packaging, stronger protection
- Lightweight and durable, easy to place and stack



Size	Head Dia.	Head L.	Shank Dia.	Shank L.	Order Code	Price RM
A1225	12	25	6	70	-40010X	769.80
C0616	6	16	6	50		
C1225	12	25	6	70		
D1211	12	10.8	6	56		
D0605	6	5	6	50		
F0618	6	18	6	56		
F1225	12	25	6	70		
G0618	6	18	6	50		
L1230	12	30	6	75		
M0618	6	18	6	50		



ABS Plastic Box

Order Code	Size (mm)	Price RM
TMCB00		
-02010B	145x105x40	56.60

5Pc Carbide Burr Set for General Machining (6mm Shank, Double Cut)

- Dedicated to the machining industry
- High quality ABS plastic box packaging, stronger protection,
- Lightweight and durable, easy to place and stack

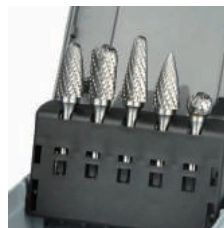

Size	Head Dia.	Head L.	Shank Dia.	Shank L.	Order Code	Price RM
D1009	10	9	6	53	-40005X	445.80
E1220	12	20	6	65		
F1225	12	25	6	70		
G1225	12	25	6	70		
M1225	12	25	6	70		



ABS Plastic Box

Order Code	Size (mm)	Price RM
TMCB00		
-01005B	145x105x40	56.60

10Pc Carbide Burr Set for Stainless Steel (6mm Shank, Single Cut)

- Dedicated to the stainless steel processing industry
- High quality ABS plastic box packaging, stronger protection,
- Lightweight and durable, easy to place and stack



Size	Head Dia.	Head L.	Shank Dia.	Shank L.	Order Code	Price RM
B1225	12	25	6	70	-40010P	915.10
B0619	6	19	6	50		
C0616	6	16	6	50		
D0605	6	5.4	6	50		
D1211	12	10.8	6	56		
F0618	6	18	6	50		
F1225	12	25	6	70		
G0618	6	18	6	50		
G1225	12	25	6	70		
L1230	12	30	6	75		



ABS Plastic Box

Order Code	Size (mm)	Price RM
TMCB00		
-02010B	145x105x40	56.60

8Pc Carbide Burr Set for Moulding Repair (3mm Shank, Double Cut)

- Dedicated to the mold maker industry
- Unique plastic cylinder packaging, good fixity, easy to carry



Size	Head Dia. mm	Head L. mm	Shank Dia. mm	Overall L. mm	Order Code TMCB88	Price RM
A0314	3	14	3	38	-40008X	171.20
B0314	3	14	3	38		
C0314	3	14	3	38		
D0303	3	2.7	3	38		
E0306	3	6	3	38		
F0313	3	13	3	38		
G0313	3	13	3	38		
L0313	3	13	3	38		

ABS Plastic Box

Order Code	Size (mm)	Price RM
TMCB00	65 × 100	14.60
-03008B	65 × 100	14.60

8Pc Carbide Burr Set for Glass Fiber & TPE (6mm Shank, Diamond Cut)

- Dedicated to the mold maker industry
- Unique plastic cylinder packaging, good fixity, easy to carry



Size	Head Dia. mm	Head L. mm	Shank Dia. mm	Overall L. mm	Order Code TMCB88	Price RM
A0616	6	16	6	50	-40108Q	599.60
B0619	6	19	6	50		
C0616	6	16	6	50		
D0605	6	5	6	50		
E0610	6	10	6	50		
F0618	6	18	6	50		
G0618	6	18	6	50		
L0616	6	16	6	50		

ABS Plastic Box

Order Code	Size (mm)	Price RM
TMCB00	65 × 100	14.60
-03008B	65 × 100	14.60

5Pc Long Shank Carbide Burr Set

- Excellent handle rigidity, not easily deformed
- High accuracy slewing, smooth and efficient processing
- Mainly suitable for deep groove and not easy reached site



Size	Head Dia. mm	Head L. mm	Shank Dia. mm	Overall L. mm	Order Code TMCB88	Price RM
A1020	10	20	6	150	-70005X	362.80
C1020	10	20	6	150		
F1020	10	20	6	150		
G1020	10	20	6	150		
L1027	10	27	6	150		

6Pc Carbide Tyre Wire Cutter Set

- For big truck tire repair, can effectively extend the life of the tire, greatly reduce the cost
- Apply to mines, oil fields, military, aerospace, construction machinery, metallurgy and other areas of heavy industry



Head Dia. mm	Head L. mm	Shank Dia. mm	Overall L. mm	Order Code TMCB50	Price RM
3	31	3	65	-10006X	1042.90
4	45	4	75		
6	52	6	80		
8	52	8	100		
10	65	10	110		
13	78	10	125		

TEMO® Special Carbide Burrs with INOX Cut

EXCELLENT

- Specifically developed carbide burrs especially for work on stainless steel (INOX) in the form of the INOX cut.
- The INOX cut is characterized by an extremely high stock removal rate on all austenitic steels, as well as rust- and acid-resistant steels.
- High performance grinding - ensuring production savings and reducing heat build up at the cutting edge and work-piece.
- In excess of 100% more stock removal compared to conventional bur geometry
- Guaranteed high performance and durability

A Shape



Size	Head Dia. (mm)	Head L. (mm)	Shank Dia. (mm)	Overall L. (mm)	Order Code TMCB60	Price RM
A03*14N03138	3	14	3	38	-10314N	22.50
A06*18N06150	6	18	6	50	-10618N	90.80
A08*18N06T63	8	18	6	63	-10818N	90.80
A10*20N06T65	10	20	6	65	-11020N	92.00
A12*25N06T70	12	25	6	70	-11225N	133.10

C Shape



Size	Head Dia. (mm)	Head L. (mm)	Shank Dia. (mm)	Overall L. (mm)	Order Code TMCB60	Price RM
C03*14N03138	3	14	3	38	-20314N	22.50
C06*18N06150	6	18	6	50	-20618N	90.80
C08*18N06T63	8	18	6	63	-20818N	90.80
C10*20N06T65	10	20	6	65	-21020N	92.00
C12*25N06T70	12	25	6	70	-21225N	133.80

D Shape



Size	Head Dia. (mm)	Head L. (mm)	Shank Dia. (mm)	Overall L. (mm)	Order Code TMCB60	Price RM
D03*2.8N03138	3	2.8	3	38	-30303N	22.50
D06*05N06150	6	5	6	50	-30605N	90.80
D08*07N06T52	8	7	6	52	-30807N	90.80
D10*09N06T54	10	9	6	54	-31009N	90.80
D12*11N06T56	12	11	6	56	-31211N	111.50

F Shape



Size	Head Dia. (mm)	Head L. (mm)	Shank Dia. (mm)	Overall L. (mm)	Order Code TMCB60	Price RM
F03*13N03138	3	13	3	38	-40313N	22.50
F06*18N06150	6	18	6	50	-40618N	90.80
F08*18N06T63	8	18	6	63	-40818N	90.80
F10*20N06T65	10	20	6	65	-41020N	90.80
F12*25N06T70	12	25	6	70	-41225N	109.00

G Shape



Size	Head Dia. (mm)	Head L. (mm)	Shank Dia. (mm)	Overall L. (mm)	Order Code TMCB60	Price RM
G03*13N03138	3	13	3	38	-50313N	20.20
G06*18N06150	6	18	6	50	-50618N	79.40
G08*18N06T63	8	18	6	63	-50818N	79.40
G10*20N06T65	10	20	6	65	-51020N	75.80
G12*25N06T70	12	25	6	70	-51225N	79.40

5Pc Special Carbide Burrs with INOX Cut Set.

- 10mm Head Dia Combination Set.
- Rose Plastic Packaging.

Size	Head Dia. (mm)	Head L. (mm)	Shank Dia. (mm)	Overall L. (mm)	Order Code TMCB89	Price RM
A10*20N06T65	10	20	6	65	-11005N	581.70
C10*20N06T65	10	20	6	65		
D10*09N06T54	10	9	6	54		
F10*20N06T65	10	20	6	65		
G10*20N06T65	10	20	6	65		

Black/Golden Finish Jobber Drills - Standard

- Good quality HSS-(M2)
- 135° double posterior angle, strong self-centering ability
- Ground Flute and Surface, high precision, good consistency
- 6mm (inclusive) above is a tri-plane shank, holding firm, to prevent slipping
- Use with the power drill or pillar drill for grey cast iron, malleable cast iron, carbon steel, die-cast steel, nickel silver, graphite materials
- Special black gold treatment enhanced the surface hardness, corrosion resistance, fast chip flow
- Manufactured to German standard DIN338



Order Code	Flute Dia. (mm)	Flute L. (mm)	Overall L. (mm)	Shank Type	Min PKG Qty	Price RM
TMDR10						
-00100A	1.0	12	34	Straight Shank	10	1.30
-00120A	1.2	16	38	Straight Shank	10	1.40
-00150A	1.5	18	40	Straight Shank	10	1.60
-00160A	1.6	20	43	Straight Shank	10	1.70
-00200A	2.0	24	49	Straight Shank	10	1.70
-00250A	2.5	30	57	Straight Shank	10	2.10
-00280A	2.8	33	61	Straight Shank	10	2.30
-00300A	3.0	33	61	Straight Shank	10	2.60
-00320A	3.2	36	65	Straight Shank	10	2.90
-00330A	3.3	36	65	Straight Shank	10	2.90
-00350A	3.5	39	70	Straight Shank	10	2.90
-00400A	4.0	43	75	Straight Shank	10	3.50
-00420A	4.2	43	75	Straight Shank	10	4.30
-00450A	4.5	47	80	Straight Shank	10	4.70
-00480A	4.8	52	86	Straight Shank	10	5.60
-00500A	5.0	52	86	Straight Shank	10	6.70
-00520A	5.2	52	86	Straight Shank	10	7.50
-00550A	5.5	57	93	Straight Shank	10	7.00
-00580A	5.8	57	93	Tri-plane Shank	10	8.20
-00600A	6.0	57	93	Tri-plane Shank	10	8.20
-00640A	6.4	63	101	Tri-plane Shank	10	9.80
-00650A	6.5	63	101	Tri-plane Shank	10	9.80
-00680A	6.8	69	109	Tri-plane Shank	10	11.40
-00700A	7.0	69	109	Tri-plane Shank	10	11.40
-00720A	7.2	69	109	Tri-plane Shank	10	13.00
-00750A	7.5	69	109	Tri-plane Shank	10	13.00
-00800A	8.0	75	117	Tri-plane Shank	5	14.00
-00850A	8.5	75	117	Tri-plane Shank	5	15.80
-00900A	9.0	81	125	Tri-plane Shank	5	18.10
-00950A	9.5	81	125	Tri-plane Shank	5	19.70
-01000A	10.0	87	133	Tri-plane Shank	5	22.80
-01020A	10.2	87	133	Tri-plane Shank	5	26.80
-01030A	10.3	87	133	Tri-plane Shank	5	24.20
-01050A	10.5	87	133	Tri-plane Shank	5	24.20
-01100A	11.0	94	142	Tri-plane Shank	5	28.60
-01150A	11.5	94	142	Tri-plane Shank	5	31.50
-01200A	12.0	101	151	Tri-plane Shank	5	35.40
-01250A	12.5	101	151	Tri-plane Shank	5	38.80
-01300A	13.0	101	151	Tri-plane Shank	5	41.80
-01350A	13.5	108	160	Tri-plane Shank	5	40.90
-01400A	14.0	108	160	Tri-plane Shank	5	62.20

Cobalt High Speed Steel Jobber Drills

- 5% Cobalt HSS-(M35)
- 135° double posterior angle, strong self-centering ability
- Excellent cutting hardness, wear resistance and toughness under high temperature
- Cutting blade quenching hardness up to HRC66 - 67, higher than the M2 drill
- ground Flute and Surface, high precision, good consistency
- Use with the machine or hand drill, suitable for stainless steel and heat-resistant steel, Titanium and so on
- Manufactured to the German standard DIN338



Order Code	Flute Dia. (mm)	Flute L. (mm)	Overall L. (mm)	Min PKG Qty	Price RM
TMDR20					
-00100C	1.0	12	34	10	2.60
-00150C	1.5	18	40	10	2.70
-00160C	1.6	20	43	10	3.00
-00200C	2.0	24	49	10	3.00
-00250C	2.5	30	57	10	3.10
-00300C	3.0	33	61	10	3.70
-00320C	3.2	36	65	10	4.50
-00330C	3.3	36	65	10	4.50
-00350C	3.5	39	70	10	4.50
-00400C	4.0	43	75	10	5.30
-00420C	4.2	43	75	10	6.50
-00450C	4.5	47	80	10	6.50
-00480C	4.8	52	86	10	8.10
-00500C	5.0	52	86	10	8.10
-00520C	5.2	52	86	10	10.10
-00550C	5.5	57	93	10	10.10
-00580C	5.8	57	93	10	7.80
-00600C	6.0	57	93	10	11.50
-00620C	6.2	63	101	10	13.40
-00650C	6.5	63	101	10	13.40
-00680C	6.8	69	109	10	16.20
-00700C	7.0	69	109	10	16.20
-00720C	7.2	69	109	10	18.20
-00750C	7.5	69	109	10	18.20
-00800C	8.0	75	117	5	20.10
-00850C	8.5	75	117	5	22.60
-00900C	9.0	81	125	5	26.80
-00950C	9.5	81	125	5	28.70
-01000C	10.0	87	133	5	33.20
-01030C	10.3	87	133	5	35.70
-01050C	10.5	87	133	5	35.70
-01100C	11.0	94	142	5	40.40
-01150C	11.5	94	142	5	44.30
-01200C	12.0	101	151	5	51.00
-01250C	12.5	101	151	5	54.70
-01300C	13.0	101	151	5	58.80
-01400C	14.0	108	160	5	61.70

HSS Jobber Drill Sets



Order Code	Number of pieces	Package	Size	Price RM
TMDR10				
-80113M	13Pc Metric	Metal Box	1.5, 2.0, 2.5, 3.0, 3.2, 3.5, 4.0, 4.5, 4.8, 5.0, 5.5, 6.0, 6.5(mm)	78.60
-80119M	19Pc Metric	Plastic Box	1.0, 1.5, 2.0, 2.5, 3.0, 3.5, 4.0, 4.5, 5.0, 5.5, 6.0, 6.5, 7.0, 7.5, 8.0, 8.5, 9.0, 9.5, 10.0(mm)	195.50
-80125M	25Pc Metric	Plastic Box	1.0, 1.5, 2.0, 2.5, 3.0, 3.5, 4.0, 4.5, 5.0, 5.5, 6.0, 6.5, 7.0, 7.5, 8.0, 8.5, 9.0, 9.5, 10.0, 10.5, 11.0, 11.5, 12.0, 12.5, 13.0(mm)	469.60
-90215N	15Pc Inch (Bright Finish)	Plastic Box	1/16", 3/32", 1/8", 5/32", 3/16", 7/32", 1/4", 9/32", 5/16", 11/32", 3/8", 13/32", 7/16", 15/32", 1/2"	275.00

150Pc HSS Black/Golden Finish Jobber Drill Set - Metric

- Made of HSS-M2, Ground Flute
- Each Size 5pcs / Specification (mm): 5.5, 6.0, 6.5, 7.0, 7.5, 8.0, 8.5, 9.0, 9.5, 10.0
- Each Size 10pcs / Specification (mm): 1.0, 1.5, 2.0, 2.5, 3.5, 4.0, 4.5, 5.0
 - 20pcs: 3mm
- DIN338 standard • Metal box packaging



Order Code	Size (mm)	Price RM
TMDR10		
-80150M	1.0 ~ 10.0	995.40

HSS-Co Jobber Drill Sets

- Made of Ground Flute, HSS-Co(M35)

Order Code	Number of pieces	Size	Price RM
TMDR20			
-80119M	19Pc Metric	1.0, 1.5, 2.0, 2.5, 3.0, 3.5, 4.0, 4.5, 5.0, 5.5, 6.0, 6.5, 7.0, 7.5, 8.0, 8.5, 9.0, 9.5, 10.0(mm)	262.20
-80125M	25Pc Metric	1.0, 1.5, 2.0, 2.5, 3.0, 3.5, 4.0, 4.5, 5.0, 5.5, 6.0, 6.5, 7.0, 7.5, 8.0, 8.5, 9.0, 9.5, 10.0, 10.5, 11.0, 11.5, 12.0, 12.5, 13.0(mm)	530.50



Black/Golden Finish Jobber Drills - Long Series

- Made of Ground Flute, HSS-Co(M35)



Order Code	Flute Overall			Price RM
	Dia. (mm)	L. (mm)	L. (mm)	
TMDR11				
-00100L	1.0	33	56	3.90
-00150L	1.5	45	70	4.30
-00200L	2.0	56	85	4.90
-00250L	2.5	62	95	5.30
-00300L	3.0	66	100	7.20
-00350L	3.5	73	112	8.90
-00400L	4.0	78	119	10.80
-00450L	4.5	82	126	13.60
-00500L	5.0	87	132	15.00
-00520L	5.2	87	132	8.70
-00550L	5.5	91	139	17.30
-00600L	6.0	91	139	19.60
-00650L	6.5	97	148	23.70

Order Code	Flute Overall			Price RM
	Dia. (mm)	L. (mm)	L. (mm)	
TMDR11				
-00700L	7.0	102	156	27.40
-00750L	7.5	102	156	30.80
-00800L	8.0	109	165	36.30
-00850L	8.5	109	165	41.30
-00900L	9.0	115	175	48.70
-00950L	9.5	115	175	52.50
-01000L	10.0	121	184	59.40
-01050L	10.5	121	184	64.50
-01100L	11.0	128	195	73.30
-01150L	11.5	128	195	79.40
-01200L	12.0	134	205	90.40
-01250L	12.5	134	205	96.40
-01300L	13.0	134	205	105.20

Black/Golden Finish Inch Size Jobber Drills - Standard

- Good Quality HSS -(M2)
- 135°Double posterior angle , strong self-centering ability
- Ground Flute and Surface , high precision , good consistency
- 1/4" (Inclusive) above is a tri-plane shank , holding firm, to prevent slipping.
- Use with the power drill or pillar drill for grey cast iron, malleable cast iron, carbon steel, die-cast steel, nickel silver, graphite materials.
- Special black gold treatment enhanced the surface harness, corrosion resistance , fast chip flow.
- Manufactured to German standard DIN338.



Order Code	Flute Dia. (mm)	Flute L. (mm)	Overall L. (mm)	Shank Type	Min PKG Qty	Price RM
TMDR10						
-10050F	1/64"	3/16"	3/4"	Straight Shank	10	1.30
-10055F	3/64"	3/4"	1-3/4"	Straight Shank	10	1.40
-10057F	1/16"	7/8"	1-7/8"	Straight Shank	10	1.90
-10059F	5/64"	1"	2"	Straight Shank	10	2.10
-10061F	3/32"	1-1/4"	2-1/4"	Straight Shank	10	2.30
-10063F	7/64"	1-1/2"	2-5/8"	Straight Shank	10	2.90
-10065F	1/8"	1-5/8"	2-3/4"	Straight Shank	10	3.20
-10070F	9/64"	1-3/4"	2-7/8"	Straight Shank	10	3.50
-10080F	5/32"	2"	3-1/8"	Straight Shank	10	4.20
-10085F	11/64"	2-1/8"	3-1/4"	Straight Shank	10	5.20
-10087F	3/16"	2-5/16"	3-1/2"	Straight Shank	10	5.90
-10091F	13/64"	2-7/16"	3-5/8"	Straight Shank	10	6.80
-10095F	7/32"	2-1/2"	3-3/4"	Straight Shank	10	7.30
-10097F	15/64"	2-5/8"	3-7/8"	Straight Shank	10	8.50
-10100F	1/4"	2-3/4"	4"	Tri-plane Shank	10	8.90
-10105F	17/64"	2-7/8"	4-1/8"	Tri-plane Shank	10	12.50
-10110F	9/32"	2-15/16"	4-1/4"	Tri-plane Shank	10	12.50
-10120F	19/64"	3-3/8"	4-3/8"	Tri-plane Shank	10	13.90
-10125F	5/16"	3-3/16"	4-1/2"	Tri-plane Shank	5	14.30
-10127F	21/64"	3-5/16"	4-5/8"	Tri-plane Shank	5	18.60
-10130F	11/32"	3-7/16"	4-3/4"	Tri-plane Shank	5	21.20
-10135F	23/64"	3-1/2"	4-7/8"	Tri-plane Shank	5	21.20
-10140F	3/8"	3-5/8"	5	Tri-plane Shank	5	21.80
-10145F	25/64"	3-3/4"	5-1/8"	Tri-plane Shank	5	22.70
-10155F	13/32"	3-7/8"	5-1/4"	Tri-plane Shank	5	27.00
-10160F	27/64"	3-15/16"	5-3/8"	Tri-plane Shank	5	30.50
-10165F	7/16"	4-1/16"	5-1/2"	Tri-plane Shank	5	30.50
-10170F	29/64"	4-3/16"	5-5/8"	Tri-plane Shank	5	33.10
-10175F	15/32"	4-5/16"	5-3/4"	Tri-plane Shank	5	37.90
-10180F	31/64"	4-3/8"	5-7/8"	Tri-plane Shank	5	40.80
-10185F	1/2"	4-1/2"	6	Tri-plane Shank	5	43.70

Solid Carbide Jobber Drills

- High hardness, high strength and good toughness and wear resistance
- Sharp cutting, chip removal fluency
- Machinable cast iron, ductile iron, carbon steel and so on
- Manufactured to the German standard DIN338



Order Code	Flute Overall			Price RM
	Dia. (mm)	L. (mm)	L. (mm)	
TMDR30				
-00100K	1.0	12	34	90.20
-00150K	1.5	18	40	90.20
-00200K	2.0	24	49	90.20
-00250K	2.5	30	57	90.20
-00300K	3.0	33	61	34.90
-00330K	3.3	36	65	44.60
-00350K	3.5	39	70	44.60
-00400K	4.0	43	75	54.00
-00420K	4.2	43	75	64.30
-00450K	4.5	47	80	64.90
-00500K	5.0	52	86	78.60
-00550K	5.5	57	93	94.20
-00600K	6.0	57	93	107.90
-00650K	6.5	63	101	127.30
-00680K	6.8	69	109	148.40
-00700K	7.0	69	109	149.30
-00750K	7.5	69	109	177.30
-00800K	8.0	75	117	194.80
-00850K	8.5	75	117	215.20
-00900K	9.0	81	125	254.00
-00950K	9.5	81	125	268.80

Order Code	Flute Overall			Price RM
	Dia. (mm)	L. (mm)	L. (mm)	
TMDR30				
-01000K	10.0	87	133	313.90
-01030K	10.3	87	133	331.20
-01050K	10.5	87	133	346.70
-01100K	11.0	94	142	394.60
-01150K	11.5	94	142	478.60
-01200K	12.0	101	151	467.90
-01250K	12.5	101	151	544.40
-01300K	13.0	101	151	576.20

25Pc sets



Order Code	Size (mm)	Advanced (mm)	Price RM
TMDR30			
-80125M	1.0 -13.0	0.5	4912.50

Carbide Micrograin End Mills for Aluminum & Brass

- Single cut center • 45° helix angle
- Unique arc gap design
- Suitable for processing aluminum alloy, copper magnesium alloy, high toughness material
- Smooth cutting edge, fast chip flow, high precision, long service life, the best choice for high speed processing

2-Flute



3-Flute



2-Flute		3-Flute		Dia. (mm)	Flute L. (mm)	Shank Dia. (mm)	Overall L. (mm)
Order Code	Price RM	Order Code	Price RM				
TMCT17		TMCT17					
-20100C	113.00	-30100C	113.00	1.0	3	4	50
-20100D	150.30	-30100D	150.30	1.0	3	6	50
-20150C	113.00	-30150C	113.00	1.5	5	4	50
-20150D	150.30	-30150D	150.30	1.5	5	6	50
-20200C	113.00	-30200C	113.00	2.0	6	4	50
-20200D	150.30	-30200D	150.30	2.0	6	6	50
-20250C	113.00	-30250C	113.00	2.5	8	4	50
-20250D	150.30	-30250D	150.30	2.5	8	6	50
-20300C	113.00	-30300C	113.00	3.0	9	4	50
-20300D	150.30	-30300D	150.30	3.0	9	6	50
-20350C	113.00	-30350C	113.00	3.5	11	4	50
-20350D	150.30	-30350D	150.30	3.5	11	6	50
-20400C	113.00	-30400C	113.00	4.0	12	4	50
-20400D	150.30	-30400D	150.30	4.0	12	6	50
-20450C	150.30	-30450C	150.30	4.5	14	6	50
-20500C	150.30	-30500C	150.30	5.0	15	6	50
-20550C	150.30	-30550C	150.30	5.5	17	6	50
-20600C	150.30	-30600C	150.30	6.0	18	6	50
-20800C	298.20	-30800C	298.20	8.0	24	8	60
-21000C	427.60	-31000C	427.60	10.0	30	10	75
-21200C	559.40	-31200C	559.40	12.0	34	12	75
-21600C	1651.50	-31600C	1651.50	16.0	48	16	100
-22000C	2108.10	-32000C	2108.10	20.0	50	20	100

HSS Taper Shank Drills

- Blind hole processing, suitable for iron, cast iron, alloy steel, carbon steel, die steel, malleable iron and other difficult to process metals
- Nitriding Treatment
- Large groove & chip space designed allow fast chip flow
- Drill Type: Roll Forged (50mm above, Milling)
- Point angle 118°, tolerance: -0.2mm • DIN345 standard



Order Code	Dia. (mm)	Flute L. (mm)	Overall L. (mm)	No. MT	Price RM
TMDR40					
-01300T	13.00	101	182	#1	51.50
-01400T	14.00	108	189	#1	58.60
-01500T	15.00	114	212	#2	58.60
-01600T	16.00	120	218	#2	63.50
-01700T	17.00	125	223	#2	74.40
-01800T	18.00	130	228	#2	79.90
-01900T	19.00	135	233	#2	84.60
-02000T	20.00	140	238	#2	100.80
-02100T	21.00	145	243	#2	116.60
-02200T	22.00	150	248	#2	122.10
-02300T	23.00	155	253	#2	137.90
-02400T	24.00	160	281	#3	159.10
-02500T	25.00	160	281	#3	164.50
-02600T	26.00	165	286	#3	202.00
-02700T	27.00	170	291	#3	206.70
-02800T	28.00	170	291	#3	217.80
-02900T	29.00	175	296	#3	249.60
-03000T	30.00	175	296	#3	292.20
-03100T	31.00	180	301	#3	329.50
-03200T	32.00	185	334	#4	372.10
-03300T	33.00	185	334	#4	414.90
-03400T	34.00	190	339	#4	428.60
-03500T	35.00	190	339	#4	473.20
-03600T	36.00	195	344	#4	514.30
-03700T	37.00	195	344	#4	630.90
-03800T	38.00	200	349	#4	630.90
-04000T	40.00	200	349	#4	634.30
-04500T	45.00	210	359	#4	888.00
-04800T	48.00	220	369	#4	1001.20
-05000T	50.00	220	369	#4	1100.60
-05200T	52.00	225	412	#5	1203.50
-05500T	55.00	230	417	#5	1306.40
-05800T	58.00	235	422	#5	1577.20
-06000T	60.00	235	422	#5	1577.20
-06500T	65.00	245	432	#5	2372.80
-07000T	70.00	250	437	#5	2767.10
-07500T	75.00	255	442	#5	3068.90
-08000T	80.00	260	514	#6	5551.30
-08500T	85.00	265	519	#6	6384.60
-09000T	90.00	270	524	#6	7272.60
-09500T	95.00	275	529	#6	8177.80
-10000T	100.0	280	534	#6	9110.50

**Carbide Co12% End Mills
- TiAlN Coated**

- With Ultra-high Co12% • WC grain 0.6um, HRA92.0
- Suitable for steel, cast iron and stainless steel roughing and semi-finishing (HRC≤55)
- TiAlN coating adhesion, good chemical stability under high temperature
- Cutting edge and groove treated by strengthening process, effectively improving the life of the tool
- Blade accuracy h9, straight shank accuracy h6
- 2 Flute helix angle 30°, 4 Flute helix angle 35°

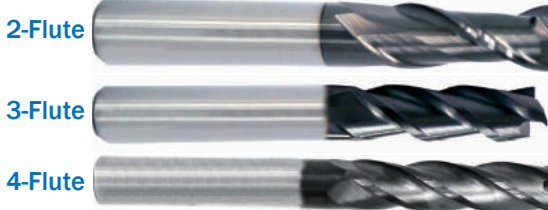

2-Flute		3-Flute		4-Flute		Dia. (mm)	Flute L. (mm)	Shank Dia. (mm)	Overall L. (mm)
Order Code	Price RM	Order Code	Price RM	Order Code	Price RM				
TMCT10		TMCT10		TMCT10					
-20100C	80.70	-30100C	80.70	-40100C	80.70	1.00	3.00	4.00	50.00
-20200C	80.70	-30200C	80.70	-40200C	80.70	2.00	6.00	4.00	50.00
-20300C	80.70	-30300C	80.70	-40300C	80.70	3.00	8.00	4.00	50.00
-20400C	80.70	-30400C	80.70	-40400C	80.70	4.00	10.00	4.00	50.00
-20500C	121.30	-30500C	121.30	-40500C	121.30	5.00	13.00	6.00	50.00
-20600C	121.30	-30600C	121.30	-40600C	121.30	6.00	16.00	6.00	50.00
-20800C	218.50	-30800C	218.50	-40800C	221.70	8.00	20.00	8.00	60.00
-21000C	319.60	-31000C	319.60	-41000C	319.60	10.00	25.00	10.00	75.00
-21200C	421.90	-31200C	421.90	-41200C	421.90	12.00	30.00	12.00	75.00

**High Performance Carbide 4
- Flute End Mills with Special
Coating**

- Fine grain carbide • 45° helix angle
- Unique arc gap design
- Smooth cutting edge, fast chip flow, high precision, long service life, the best choice for high speed processing
- Applicable cutting materials: A3, S45C, S50C, 40Cr, 42CrMo, 20Cr, Cr12, H13, NAK80, 718 carbon steel and other structural steel, Alloy steel, cast steel, die steel (HRC≤55)



4-Flute	Order Code	Dia. (mm)	Flute L. (mm)	Shank Dia. (mm)	Overall L. (mm)	Price RM
	TMCT18					
	-40300C	3	8	4	50	119.40
	-40400C	4	10	4	50	119.40
	-40500C	5	13	6	50	157.00
	-40600C	6	15	6	50	157.00
	-40800C	8	20	8	60	320.60
	-41000C	10	25	10	75	493.10
	-41200C	12	30	12	75	680.30
	-41600C	16	40	16	100	1842.70
	-42000C	20	45	20	100	2596.30

**High Performance Carbide 2-Flute Ball
Nose End Mills with Special Coating**

- Fine grain carbide • HRC hardness ≤ 55°
- Special coating to ensure that the tool can be used at high speed
- The most suitable for processing carbon steel (HRC30), alloy steel (HRC25 ~ 30), quenched and tempered steel (HRC30 ~ 40) and copper; also suitable for processing burning steel (HRC55) and stainless steel (HRC25 ~ 35) and so on

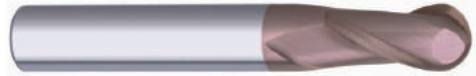

2-Flute

Order Code	R Dia.	Front End (mm)	Flute L. (mm)	Shank Dia. (mm)	Overall L. (mm)	Price RM
TMCT18						
-40100B	0.5R	1	2	4	50	150.10
-40150B	0.75R	1.5	3	4	50	150.10
-40200B	1R	2	4	4	50	150.10
-40250B	1.25R	2.5	5	4	50	150.10
-40300B	1.5R	3	6	4	50	150.10
-40350B	1.75R	3.5	7	4	50	150.10
-40400B	2R	4	8	4	50	150.10
-40500B	2.5R	5	10	6	50	217.30
-40600B	3R	6	12	6	50	217.30
-40700B	3.5R	7	14	8	60	395.90
-40800B	4R	8	16	8	60	395.90
-40900B	4.5R	9	18	10	75	631.30
-41000B	5R	10	20	10	75	631.30
-41100B	5.5R	11	22	12	75	835.60
-41200B	6R	12	24	12	75	835.60
-41600B	8R	16	32	16	100	2382.60
-42000B	10R	20	40	20	100	3479.40

5Pc HSS Center Drill Sets



Order Code	Style	Size (mm)	Price RM
TMDR50-80105M	A type	1.0, 2.0, 3.15, 4.0, 5.0	129.90
TMDR51-80105M	B type	1.0, 2.0, 3.15, 4.0, 5.0	186.00
TMDR52-80105M	R type	1.0, 2.0, 3.15, 4.0, 5.0	129.90

ABS Plastic Box

Order Code	Size (mm)	Price RM
TMDR00		
-03001B	120 × 85 × 34	57.00

HSS Center Drills Type A

- High hardness, high strength and good toughness and wear resistance
- Sharp cutting, chip removal fluency
- Machinable cast iron, ductile iron, carbon steel and so on
- Manufactured to the German standard DIN338

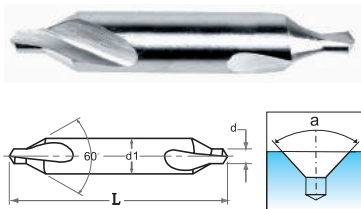

A Type

Order Code	Pilot Dia (d) (mm)	Body Dia (d1) (mm)	Overall L.(L) (mm)	Price RM
TMDR50				
-00050A	0.50	3.15	31.5	11.60
-00080A	0.80	3.15	31.5	11.60
-00100A	1.00	3.15	31.5	8.30
-00125A	1.25	3.15	31.5	8.30
-00160A	1.60	4.00	35.5	8.30
-00200A	2.00	5.00	40.0	9.30
-00250A	2.50	6.30	45.0	10.50
-00315A	3.15	8.00	50.0	11.20
-00400A	4.00	10.00	56.0	18.80
-00500A	5.00	12.50	63.0	24.60
-00630A	6.30	16.00	71.0	40.60
-01000A	10.00	25.00	100.0	222.50

HSS Center Drills Type B

- High-quality HSS material
- Suitable for processing steel, cast iron parts, non-ferrous metals and light metal, mainly used for precision parts processing
- Automatic feeding easier access and positioning, ensures a more stable process
- Comply with DIN333B standards

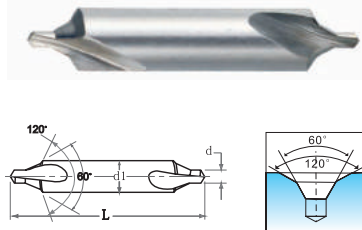

B Type

Order Code	Pilot Dia (d) (mm)	Body Dia (d1) (mm)	Overall L.(L) (mm)	Price RM
TMDR51				
-00100B	1.00	4.00	35.50	9.70
-00125B	1.25	5.00	40.00	9.70
-00160B	1.60	6.30	45.00	10.90
-00200B	2.00	8.00	50.00	11.50
-00250B	2.50	10.00	56.00	23.50
-00315B	3.15	11.20	60.00	23.30
-00400B	4.00	14.00	67.00	34.90
-00500B	5.00	18.00	75.00	67.00
-00630B	6.30	20.00	80.00	93.90
-00800B	8.00	25.00	100.00	221.30
-01000B	10.00	31.50	125.00	367.80

HSS Center Drills Type R

- Made of high-quality HSS
- Suitable for processing steel, cast iron parts, non-ferrous metals and light metal, mainly used for precision parts processing
- Arc structure to reduce the risk of fracture, smooth arc surface enables the drill tip to withstand greater strength and thus extended service life
- Manufactured to DIN333R standards

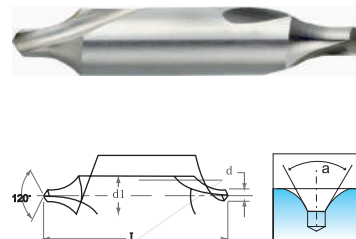

R Type

Order Code	Pilot Dia (d) (mm)	Body Dia (d1) (mm)	Overall L.(L) (mm)	Price RM
TMDR52				
-00100R	1.00	3.15	31.50	13.20
-00160R	1.60	4.00	35.50	13.20
-00200R	2.00	5.00	40.00	14.40
-00250R	2.50	6.30	45.00	16.80
-00315R	3.15	8.00	50.00	21.50
-00400R	4.00	10.00	56.00	30.10
-00500R	5.00	12.50	63.00	39.80
-00630R	6.30	16.00	71.00	68.80
-01000R	10.00	25.00	100.00	359.80

HSS Spiral Flute Step Drills

- High-quality HSS-M2
- Drill tip comply with DIN1412C standards, has a good self-centering ability, cutting light
- Fully grinded by CBN grinding wheel to ensure a better cutting edge angle, sharp cutting
- Large chip space to allow chip flow
- Each step and cone have a continuous radial clearance and axial relief, easy to regrind
- Self-centering drilling & reaming completed at once
- Especially suitable for metal, plastic, wood and other materials of pipe, sheet drilling and reaming
- 9 steps: 4 - 12 (4, 5, 6, 7, 8, 9, 10, 11, 12) mm
- 9 steps: 4 - 20 (4, 6, 8, 10, 12, 14, 16, 18, 20) mm
- 14 steps: 4 - 30 (4, 6, 8, 10, 12, 14, 16, 18, 20, 22, 24, 26, 28, 30) mm

- TiN (titanium nitride) coating, can improve tool surface hardness and high temperature stability, reduce the friction coefficient of the tool surface, improve tool life
- TiAlN (titanium aluminum nitrides) coating, can improve the tool surface hardness and high temperature stability, low thermal conductivity, greatly raised the performance of wear resistance, chemical stability and oxidation resistance thus double the tools life time

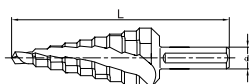

Range (mm)	Number of Steps	Shank Dia. (d) (mm)	Overall L.(L) (mm)	No Coating		TiN Coated		TiAlN Coated			
				Order Code	TMDR60	Price RM	Order Code	TMDR61	Price RM	Order Code	TMDR62
4 - 12	9	6	65	-10412A		37.40	-20412A		42.70	-30412A	87.50
4 - 20	9	8	75	-10420A		67.10	-20420A		79.00	-30420A	152.20
4 - 30	14	10	100	-10430A		162.30	-20430A		179.70	-30430A	284.40
6 - 40.5	11	10	96	-10440A		344.90	-20440A		386.40	-30440A	610.40

3Pc HSS Spiral Flute Step Drill Set

- High-quality HSS-M2
- Products include:
4-12 mm, 4-20 mm,
4-30 mm, 1 each

Order Code	Size (mm)	Price RM
TMDR60		
-80103M	4 ~ 30	433.10

ABS Plastic Box

Order Code	Size (mm)	Price RM
TMDR00		
-04001B	145 × 105 × 40	57.80



3Pc HSS Spiral Flute Step Drill Set - TiN Coated

- High-quality HSS-M2, TiN Coating Treatment
- Products include:
4-12 mm, 4-20 mm,
4-30 mm, 1 each

Order Code	Size (mm)	Price RM
TMDR61		
-80103M	4 ~ 30 (TiN)	577.90

ABS Plastic Box

Order Code	Size (mm)	Price RM
TMDR00		
-04001B	145 × 105 × 40	57.80



3Pc HSS Spiral Flute Step Drill Set - TiAlN Coated

- High-quality HSS-M2, TiAlN Coating Treatment
- Products include:
4-12 mm, 4-20 mm,
4-30 mm, 1 each

Order Code	Size (mm)	Price RM
TMDR62		
-80103M	4 ~ 30 (TiAlN)	720.60

ABS Plastic Box

Order Code	Size (mm)	Price RM
TMDR00		
-04001B	145 × 105 × 40	57.80



3Pc HSS Tube and Sheet Metal Drill Set

- High-quality HSS-M2
- Products include:
3 - 14mm, 6 - 20mm,
16 - 30.5mm, 1 each

Order Code	Size (mm)	Price RM
TMDR65		
-80103M	3 ~ 30.5	281.10

ABS Plastic Box

Order Code	Size (mm)	Price RM
TMDR00		
-04002B	145 × 105 × 40	57.80



HSS Tube and Sheet Metal Drills

- High-quality HSS-M2
- Drill tip comply with DIN1412C standards, with good self-centering ability, cutting light
- Fully grinded by CBN grinding wheel to ensure a better edge angle, sharp cutting
- Large chip space to allow chip flow
- Standard rake, efficient cutting
- Self-centering drilling & reaming completed at once
- Suitable for processing non-ferrous metals, steel, plastic and other materials (thickness ≤ 3mm)

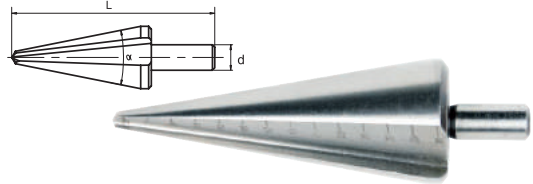

Order Code	Cutting Range (mm)	Shank Dia. (d) (mm)	Overall L.(L) (mm)	Price RM
TMDR65				
-10314A	3 - 14	6	58	36.80
-10322A	3 - 22.5	8	73	68.70
-10325A	3 - 25.4	10	87	86.50
-10331A	3 - 31	9	102	92.50
-10620A	6 - 20	8	72	52.70
-10630A	6 - 30	10	94	96.40
-11630A	16 - 30.5	9	73	96.40
-12640A	26 - 40	10	86	219.90
-13650A	36 - 50	12	93	337.20
-14061A	40 - 61	13	100	389.00

90 ° HSS 3-Flute Countersinks

- High-quality HSS
- Used for countersunk chamfering and deburring good finish, sharp edge
- Large flute ensures fast chip flow
- Conical surface with a continuous angle, easy for edge cutting re-grind
- Cutting stable, no vibration
- Ideal self-centering ability
- Low cutting heat, stable and smooth processing
- After processing the surface smooth, scratch-free and good roundness
- Suitable for processing steel, stainless steel, non-ferrous metals, cast iron and other materials
- Comply with the German standard DIN335C

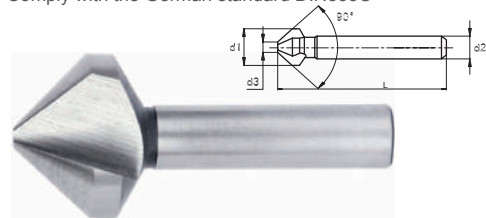

Order Code	Dia. (d1) (mm)	Top Trail (d3) (mm)	Shank Dia. (d2) (mm)	Overall L.(L) (mm)	Price RM
TMDR70					
-00630A	6.30	1.5	5	45	30.60
-00830A	8.30	2.0	6	50	37.90
-01040A	10.4	2.5	6	50	42.50
-01240A	12.4	2.8	8	56	52.70
-01650A	16.5	3.2	10	60	75.20
-02050A	20.5	3.5	10	63	91.10
-02500A	25.0	3.8	10	67	119.50
-03100A	31.0	4.2	12	71	159.60

90° HSS Morse Taper Shank 3-Flute Countersinks

- High-quality HSS
- Good finishing, sharp edge
- Conical surface with a continuous angle, easy for cutting edge re-grind
- Low cutting heat, stable and smooth processing
- Ideal self-centering ability
- After processing smooth, scratch-free surface and good roundness
- Suitable for processing steel, stainless steel, non-ferrous metals, castings and other materials



Order Code	Cutting Dia.(D) (mm)	Top Dia.(d1) (mm)	Overall L.(L) (mm)	Taper Shank (Morse)	Price RM
TMDR76					
-01650A	16.5	3.2	85	NO.1	162.00
-02050A	20.5	3.5	100	NO.2	194.40
-02500A	25	3.8	106	NO.2	238.90
-03100A	31	4.2	112	NO.2	388.70
-04000A	40	10	140	NO.3	741.00
-05000A	50	14	150	NO.3	1275.50
-06300A	63	16	180	NO.4	1984.10
-08000A	80	22	190	NO.4	2227.00

HSS-Co Precision Piloted 3-Flute Countersinks

- High-quality 5% cobalt HSS (M35)
- Smooth surface, sharp edge
- Improved cutting angle to ensure smooth cutting without vibration, forming high-precision & smooth tapered hole
- Suitable for chamfering & countersinking at high-precision of high-concentricity hole

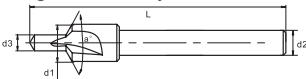

Cutting Dia. d1	Guide Column Dia. d3	Shank Dia. d2	Overall L. L	90° Order Code TMDR78	Price RM
3/16"(4.76mm)	3/32"(2.38mm)	3/16"(4.76mm)	2-1/2"(63mm)	-00476A	11.10
1/4"(6.35mm)	3/32"(2.38mm)	3/16"(4.76mm)	2-1/2"(63mm)	-00635A	13.70
1/4"(6.35mm)	1/8"(3.17mm)	3/16"(4.76mm)	2-1/2"(63mm)	-00635B	13.70
5/16"(7.93mm)	1/8"(3.17mm)	3/16"(4.76mm)	2-1/2"(63mm)	-00793A	19.20
5/16"(7.93mm)	5/32"(3.96mm)	3/16"(4.76mm)	2-1/2"(63mm)	-00793B	19.20
3/8"(9.53mm)	5/32"(3.96mm)	3/16"(4.76mm)	2-1/2"(63mm)	-00953A	22.50
3/8"(9.53mm)	3/16"(4.76mm)	3/16"(4.76mm)	2-1/2"(63mm)	-00953B	22.50
7/16"(11.11mm)	7/32"(5.56mm)	3/16"(4.76mm)	2-1/2"(63mm)	-01111A	23.70
7/16"(11.11mm)	1/4"(6.35mm)	3/16"(4.76mm)	2-1/2"(63mm)	-01111B	23.70
1/2"(12.7mm)	1/4"(6.35mm)	3/16"(4.76mm)	2-1/2"(63mm)	-01270A	33.30

90° HSS Single Hole Deburring Countersinks

- High-quality HSS
- 90° countersunk metal sink hole and deburring to reduce the debris, After processing the object surface smooth
- Good finishing, sharp cutting edge
- Single hole to ensure chip removal smooth, fast, to prevent the workpiece clogging
- Conical surface with a continuous angle, easy for cutting edge re-grind
- Low cutting heat, stable and smooth processing
- After processing smooth and scratch-free surface
- Easy re-grind the cutting blade by grinding the hole with a ceramic grinding head
- Suitable for processing non-ferrous metals, light metals and plastics and other materials



Order Code	Cutting Range(d1) (mm)	Shank Dia.(d2) (mm)	Overall L.(L) (mm)	Price RM
TMDR77				
-00104A	1 - 4	6	45	44.50
-00205A	2 - 5	6	45	44.50
-00510A	5 - 10	8	48	60.00
-01015A	10 - 15	10	65	101.30
-01520A	15 - 20	12	85	184.60
-02025A	20 - 25	15	102	281.50
-02530A	25 - 30	15	115	421.10
-03035A	30 - 35	15	127	526.40

7Pc 90° HSS 3-Flute Countersink Set

- Set Contents:
 - Φ6.3mm,
 - Φ8.3mm,
 - Φ10.4mm,
 - Φ12.4mm,
 - Φ16.5mm,
 - Φ20.5mm
- Cutting paste

Order Code	Size (mm)	Price RM
TMDR70	6.3 ~ 20.5	189.20
-80107M	6.3 ~ 20.5	189.20

4Pc 90° HSS Single Hole Deburring Countersink Set

- Set Contents:
 - Φ2 - 5mm,
 - Φ5 - 10mm,
 - Φ10 - 15mm,
 - Φ15 - 20mm

Order Code	Size (mm)	Price RM
TMDR77	2 ~ 20	218.60
-80104M	2 ~ 20	218.60

Cutting Paste

- Suitable for all metals, including hardened steel, titanium and nickel alloys
- This product perform a effective lubricant role in reaming, tapping, drilling and other heavy metal cutting process
- Significantly reduce the cutting friction, effectively prevent and reduce temperature rise
- Brush directly on the tool or workpiece
- The product complies with the REACH directive

Order Code	Weight (g)	Price RM
TMLB30	20	14.20
-00120A	20	14.20

High Torque Screw Extractors

Coarse Pitch

- Made of High-strength chrome vanadium steel, overall heat treatment. High hardness, toughness and durability
- Used to remove broken screws, bolts, threaded parts, dowels and inner tube sets
- Easy to use



Order Code	Drill Bits		For Removing Screws Sized		Price RM
	Code	Inch (mm)	Metric	Imperial	
-20001B	No.1	5/64" 2.0	M5 ~ M6	3/16" ~ 1/4"	6.30
-20002B	No.2	7/64" 2.8	M6 ~ M8	1/4" ~ 5/16"	7.50
-20003B	No.3	5/32" 4.0	M8 ~ M11	5/16" ~ 7/16"	9.00
-20004B	No.4	1/4" 6.4	M11 ~ M14	7/16" ~ 9/16"	11.60
-20005B	No.5	19/64" 7.5	M14 ~ M19	9/16" ~ 3/4"	15.50
-20006B	No.6	13/32" 10.3	M19 ~ M25	3/4" ~ 1"	28.40

5Pc High Torque Coarse Pitch Screw Extractor Set in Canvas Pouch

- Durable Canvas Bag



For Removing Screws Sized

Code	Metric	Imperial
No.1	M5 ~ M6	3/16" ~ 1/4"
No.2	M6 ~ M8	1/4" ~ 5/16"
No.3	M8 ~ M11	5/16" ~ 7/16"
No.4	M11 ~ M14	7/16" ~ 9/16"
No.5	M14 ~ M19	9/16" ~ 3/4"

Order Code	Size	Number	Price RM
-80205M	No.1 ~ No.5	5Pc	83.00

Fine Pitch

- High-quality high-strength alloy steel
- Large torque
- Can easily remove damaged screws without damaging the screw holes



Order Code	Code	Drill Bits	For Removing Screws Sized	Price RM
		(mm)		
-10001A	No.1	2.0	M3 ~ M6	4.10
-10002A	No.2	2.8	M6 ~ M8	4.40
-10003A	No.3	4.0	M8 ~ M11	5.50
-10004A	No.4	6.4	M11 ~ M14	8.00
-10005A	No.5	6.8	M14 ~ M18	11.60
-10006A	No.6	10.3	M18 ~ M25	22.90

High Torque Fine Pitch Screw Extractor Sets



Order Code	Size	Number	Price RM
-80105M	No.1 ~ No.5	5Pc	33.90
-80106M	No.1 ~ No.6	6Pc	59.80

12Pc High Torque Fine Pitch Screw Extractor & Drill Set

- Specification:
High torque screw extractor:
No.1, No.2, No.3, No.4, No.5, No.6
Black gold HSS twist drill:
2.0 mm, 3.0 mm, 4.0 mm, 6.5 mm, 7.0 mm, 10.2 mm



Order Code	Price RM
-80112M	142.20

Straight Flute

- High-strength chrome vanadium steel, overall heat treatment. High hardness, toughness and durability
- Remove broken screws, bolts, threaded parts, pins and inner tube
- easy to use



Order Code	Code	Drill Bits		For Removing Screws Sized	Price RM
		Inch	Metric(mm)		
-30001C	No.1	9/64" 3.6	3/16" - 5/16"	7.30	
-30002C	No.2	3/16" 4.8	3/8"	8.30	
-30003C	No.3	15/64" 6.0	7/16"	11.40	
-30004C	No.4	5/16" 8.0	1/2" - 9/16"	14.40	
-30005C	No.5	3/8" 9.5	5/8"	18.60	
-30006C	No.6	15/32" 12.0	3/4"	32.60	

5Pc Straight Flute Screw Extractor Set in Canvas Pouch

- Durable Canvas Bag



For Removing Screws Sized

Code	Imperial
No.1	3/16" - 5/16"
No.2	3/8"
No.3	7/16"
No.4	1/2" - 9/16"
No.5	5/8"

订货号	Size	Number	Price RM
TMDR80			
-90305N	No.1 ~ No.5	5Pc	125.20

Twist Socket Sets

- High strength chromium molybdenum steel, with good wear resistance, good toughness and impact resistance
- Left-handed spiral blade design, can be easily and firmly lock damaged nut

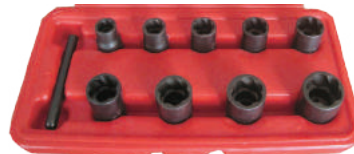

Order Code	Square Drive	Number of pieces	Specification	Price RM
-20110M	3/8"	10	9Pcs Metric Twist Sockets Set (mm): 10, 11, 12, 13, 14, 15, 16, 17, 19 1 piece percussion stick	334.10
-30115M	1/2"	15	7Pcs Metric Twist Sockets Set (mm): 10, 11, 12, 13, 14, 15, 16, 17 7Pcs Inch Twisr Sockets Set: (Inch) 3/4", 13/16", 7/8", 15/16", 1", 1-3/16" 1 piece percussion stick	661.90

Metric Solid Carbide Tap Extractors

- Made from Ultra-Fine grain solid carbide material.
- Easily remove broken screws ,bolts etc, without damaging the threads of the part.
- Suitable for all types of HSS screws ,taps ,screw grooves etc.
- Also suitable for hard material such as harden steels , glass etc. Cutting.
- Cutting speed within 1500-3000rpm, no cutting fluid is required.



Metric						
Order Code	Dia (mm)	Flute L. (mm)	Overall L. (mm)	For removing screw size		Price RM
TMDR83				Metric	Imperial	
-00200C	2.0	10	31	M3	No.4,	55.10
-00300C	3.0	14	40	M4, M5	No.8, No.10, No.12	62.20
-00400C	4.0	20	46	M6, M7	1/4", 5/16"	82.50
-00500C	5.0	24	50	M8, M10	5/16", 3/8"	103.00
-00600C	6.0	30	60	M10, M12	7/16", 1/2"	134.60

5Pc Metric Solid Carbide Tap Extractor Set

- Products include:
2.0mm, 3.0mm
4.0mm, 5.0mm
6.0mm



Order Code	Number of pieces	Size	Price RM
TMDR83			
-80105M	5	2 ~ 6mm	449.10

Thread Repair Kits

- Used to remove broken inner threaded parts and repair without damaging the thread of the component.
- Taps and drill are made from Industrial grade HSS materials
- Thread inserts are made from stainless steel materials.
- Contents :
1 x Installation Handle
1 x Installation Handle Key
1 x Breaking Tool
1 x Jobber Drill
1 x Screw Taps



Order Code	Size	Drill bit size	Price RM
TMTR88			
-71004M	M4 x 0.7	4.2mm	105.80
-71005M	M5 x 0.8	5.2mm	112.90
-71006M	M6 x 1	6.2mm	127.00
-71008M	M8 x 1.25	8.3mm	141.10
-71010M	M10 x 1.5	10.3mm	169.30
-71012M	M12 x 1.75	12.4mm	211.70
-71014M	M14 x 2	14.3mm	239.90

Stainless Steel Drill Gauges

- Used to measure drill bits size accurately and quickly.
- Metric: 1, 1.5, 2, 2.5, 3, 3.2, 3.5, 4, 4.2, 4.5, 4.8, 5, 5.2, 5.5, 6, 6.5, 7, 7.5, 8, 8.5, 9, 9.5, 10, 10.5, 11, 11.5, 12, 12.5 & 13mm
- Imperial: 1/32, 3/64, 1/16, 5/64, 3/32, 7/64, 1/8, 9/64, 5/32, 10.5/64, 11/64, 3/16, 12.5/64, 13/64, 7/32, 15/64, 1/4, 17/64, 19/64, 5/16, 21/64, 11/32, 3/8, 25/64, 13/32, 7/16, 29/64, 15/32, 31/64 & 1/2

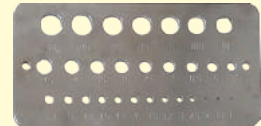

Order Code	Type	Travel	Price RM
TMME61			
-61130A	Metric	1 - 13mm	81.80
-61140B	Imperial	1/32"-1/2"	81.80

90° HSS-Co TiN Coated Spot Drills

- Made from M35 HSS materials
- High hardness , high strength and good toughness and wear resistance.
- Processable cast iron, nodular cast iron, carbon steel, stainless steel , etc.
- Sharp cutting and smooth chip removal.
- Long lasting and money-saving.
- Comply with German standard DIN338.



Order Code	Size (mm)	Flute L. (mm)	Overall L. (mm)	Price RM
TMDR54				
-02003C	3	17	50	9.50
-02004C	4	20	55	13.60
-02005C	5	23	60	15.00
-02006C	6	25	65	16.30
-02008C	8	30	80	21.70
-02010C	10	35	90	40.70
-02012C	12	40	100	67.80

HSS Combined Drill Taps

- Made from M2 HSS materials
- Spiral flute tap design reduces drill & tap breakage.
- Spiral flute tap design pulls chips back from the tip of the tool and out of the hole prevent clogging.

Square Head - Hand



1/4" Hex Head - Machine



Square Head		Hex Head		Overall Thread Drill bit					
Order Code	Price RM	Order Code	Price RM	Size (mm)	Pitch (mm)	L. (mm)	L. (mm)	L. (mm)	Square (mm)
TMTR50		TMTR50							
-10300S	30.90	-10300H	36.80	M3.0	0.50	66.0	13.0	4.0	2.5
-10400S	33.70	-10400H	39.70	M4.0	0.70	67.0	14.0	5.0	3.3
-10500S	36.50	-10500H	42.40	M5.0	0.80	68.0	15.0	6.0	4.2
-10600S	39.30	-10600H	45.30	M6.0	1.00	69.0	16.0	7.0	5.0
-10800S	50.60	-10800H	56.50	M8.0	1.25	71.0	18.0	9.0	6.8
-11000S	56.20	-11000H	62.20	M10.0	1.50	73.0	20.0	11.0	8.5

Metric Coarse HSS Taps

- Standard: ISO529
- Tolerance: H2

Hand Taps



Machine Taps



Spiral Point Nitride Finish - Machine Taps

Set of 3 Hand Taps

Size	Pitch (TPI)	Overall L. (mm)	Thread L. (mm)	Shank Dia. (mm)	Square (mm)	Order Code TMTR10	Price RM	Order Code TMTR10	Price RM
M1.6	0.35	41.00	8.00	2.50	2.00	-20160E	49.40	-10160D	123.40
M2	0.40	41.00	8.00	2.50	2.00	-20200E	41.00	-10200D	100.50
M2.2	0.45	44.50	9.50	2.80	2.24	-20220E	41.00	-10220D	100.50
M2.5	0.45	44.50	9.50	2.80	2.24	-20250E	41.00	-10250D	100.50
M2.6	0.45	44.50	9.50	2.80	2.24	-20260E	41.00	-10260D	100.50
M3	0.50	48.00	11.00	3.15	2.50	-20300E	33.10	-10300D	79.00
M3.5	0.60	50.00	13.00	3.55	2.80	-20350E	33.10	-10350D	79.00
M4	0.70	53.00	13.00	4.00	3.15	-20400E	33.10	-10400D	79.00
M4.5	0.75	53.00	13.00	4.50	3.55	-20450E	33.10	-10450D	79.00
M5	0.80	58.00	16.00	5.00	4.00	-20500E	33.10	-10500D	79.00
M6	1.00	66.00	19.00	6.30	5.00	-20600E	35.20	-10600D	84.50
M7	1.00	66.00	19.00	7.10	5.60	-20700E	42.50	-10700D	104.90
M8	1.25	72.00	22.00	8.00	6.30	-20800E	42.50	-10800D	104.90
M9	1.25	72.00	22.00	9.00	7.10	-20900E	52.80	-10900D	132.70
M10	1.50	80.00	24.00	10.00	8.00	-21000E	68.20	-11000D	163.50
M11	1.50	85.00	25.00	8.00	6.30	-21100E	81.80	-11100D	200.60
M12	1.75	89.00	29.00	9.00	7.10	-21200E	81.80	-11200D	200.60
M14	2.00	95.00	30.00	11.20	9.00	-21400E	95.30	-11400D	237.60
M16	2.00	102.00	32.00	12.50	10.00	-21600E	112.30	-11600D	283.90
M18	2.50	112.00	37.00	14.00	11.20	-21800E	129.30	-11800D	330.20
M20	2.50	112.00	37.00	14.00	11.20	-22000E	146.20	-12000D	376.50
M22	2.50	118.00	38.00	16.00	12.50	-22200E	210.70	-12200D	552.30
M24	3.00	130.00	45.00	18.00	14.00	-22400E	275.30	-12400D	728.20
M27	3.00	135.00	45.00	20.00	16.00	-22700E	336.30	-12700D	894.90
M30	3.50	138.00	48.00	20.00	16.00	-23000E	404.20	-13000D	990.50
M33	3.50	151.00	51.00	22.40	18.00	-23300E	472.10	-13300D	1105.10
M36	4.00	162.00	57.00	25.00	20.00	-23600E	573.90	-13600D	1385.30
M39	4.00	170.00	60.00	28.00	22.40	-23900E	641.80	-13900D	1517.60
M42	4.50	170.00	60.00	28.00	22.40	-24200E	777.60	-14200D	1930.10
M45	4.50	187.00	67.00	31.50	25.00	-24500E	913.40	-14500D	2295.90
M48	5.00	187.00	67.00	31.50	25.00	-24800E	1015.20	-14800D	2630.60
M52	5.00	200.00	70.00	35.50	28.00	-25200E	1218.90	-15200D	3035.20
M56	5.50	200.00	70.00	35.50	28.00	-25600E	2067.40	-15600D	5284.40

UNF HSS Taps

- Standard: ISO529
- Tolerance: H2

Hand Taps



Machine Taps



Spiral Point Nitride Finish - Machine Taps

Set of 3 Hand Taps

Size	Pitch (TPI)	Overall L. (mm)	Thread L. (mm)	Shank Dia. (mm)	Square (mm)	Order Code TMTR11	Price RM	Order Code TMTR11	Price RM
1/4"	28.00	66.00	19.00	6.30	5.00	-50030E	50.60	-40030D	84.50
5/16"	24.00	69.00	19.00	8.00	6.30	-50033E	58.00	-40033D	104.90
3/8"	24.00	76.00	20.00	10.00	8.00	-50036E	68.20	-40036D	132.70
7/16"	20.00	82.00	22.00	8.00	6.30	-50039E	81.80	-40039D	200.60
1/2"	20.00	84.00	24.00	9.00	7.10	-50042E	85.20	-40042D	179.00
9/16"	18.00	90.00	25.00	11.20	9.00	-50045E	95.30	-40045D	237.60
5/8"	18.00	95.00	25.00	12.50	10.00	-50048E	112.30	-40048D	283.90
3/4"	16.00	104.00	29.00	14.00	11.20	-50051E	146.20	-40051D	376.50
7/8"	14.00	113.00	33.00	16.00	12.50	-50054E	210.70	-40054D	552.30
1"	12.00	120.00	35.00	18.00	14.00	-50057E	302.40	-40057D	802.30
1-1/8"	12.00	127.00	37.00	20.00	16.00	-50060E	370.30	-40060D	987.40
1-1/4"	12.00	137.00	37.00	22.40	18.00	-50063E	506.10	-40063D	1357.70
1-3/8"	12.00	144.00	39.00	25.00	20.00	-50066E	573.90	-40066D	1542.90
1-1/2"	12.00	149.00	39.00	28.00	22.40	-50069E	607.90	-40069D	1635.40

Metric Fine HSS Taps • Standard: ISO529 • Tolerance: H2

Hand Taps



Machine Taps



Spiral Point Nitride Finish - Machine Taps

Set of 3 Hand Taps

Size	Pitch (TPI)	Overall L. (mm)	Thread L. (mm)	Shank Dia. (mm)	Square (mm)	Order Code	Price	Order Code	Price
						TMTR10	RM	TMTR10	RM
M3	0.35	48.00	11.00	3.15	2.50	-50300E	33.10	-40300D	79.00
M4	0.50	53.00	13.00	4.00	3.15	-50400E	33.10	-40400D	79.00
M5	0.50	58.00	16.00	5.00	4.00	-50500E	33.10	-40500D	79.00
M5	0.90	58.00	16.00	5.00	4.00	-50501E	33.10	-40501D	79.00
M6	0.75	66.00	19.00	6.30	5.00	-50600E	34.90	-40600D	84.00
M7	0.75	66.00	19.00	7.10	5.60	-50700E	42.50	-40700D	104.90
M8	0.75	69.00	19.00	8.00	6.30	-50800E	42.50	-40800D	104.90
M8	1.00	69.00	19.00	8.00	6.30	-50801E	42.50	-40801D	104.90
M9	1.00	69.00	19.00	9.00	7.10	-50900E	52.80	-40900D	132.70
M10	1.00	76.00	20.00	10.00	8.00	-51000E	68.20	-41000D	163.50
M10	1.25	76.00	20.00	10.00	8.00	-51001E	68.20	-41001D	163.50
M12	1.00	84.00	24.00	9.00	7.10	-51200E	81.80	-41200D	200.60
M12	1.25	84.00	24.00	9.00	7.10	-51201E	81.80	-41201D	200.60
M12	1.50	89.00	29.00	9.00	7.10	-51202E	81.80	-41202D	200.60
M14	1.00	90.00	25.00	11.20	9.00	-51400E	95.30	-41400D	237.60
M14	1.25	90.00	25.00	11.20	9.00	-51401E	95.30	-41401D	237.60
M14	1.50	95.00	30.00	11.20	9.00	-51402E	95.30	-41402D	237.60
M16	1.00	95.00	25.00	12.50	10.00	-51600E	112.30	-41600D	283.90
M16	1.50	102.00	32.00	12.50	10.00	-51601E	112.30	-41601D	283.90
M18	1.00	104.00	29.00	14.00	11.20	-51800E	129.30	-41800D	330.20
M18	1.50	104.00	29.00	14.00	11.20	-51801E	129.30	-41801D	330.20
M20	1.00	104.00	29.00	14.00	11.20	-52000E	146.20	-42000D	376.50
M20	1.50	104.00	29.00	14.00	11.20	-52001E	146.20	-42001D	376.50
M20	2.00	112.00	37.00	14.00	11.20	-52002E	146.20	-42002D	376.50
M22	1.50	113.00	33.00	16.00	12.50	-52200E	210.70	-42200D	552.30
M24	1.50	120.00	35.00	18.00	14.00	-52400E	275.30	-42400D	728.20
M24	2.00	120.00	35.00	18.00	14.00	-52401E	275.30	-42401D	728.20
M25	1.50	120.00	35.00	18.00	14.00	-52500E	275.30	-42500D	728.20
M27	2.00	127.00	37.00	20.00	16.00	-52700E	336.30	-42700D	894.90
M30	1.50	127.00	37.00	20.00	16.00	-53000E	404.20	-43000D	1080.00
M30	2.00	127.00	37.00	20.00	16.00	-53001E	404.20	-43001D	1080.00
M32	1.50	137.00	37.00	22.40	18.00	-53200E	472.10	-43200D	1265.10

UNC HSS Taps • Standard: ISO529 • Tolerance: H2

Hand Taps



Machine Taps



Spiral Point Nitride Finish - Machine Taps

Set of 3 Hand Taps

Size	Pitch (TPI)	Overall L. (mm)	Thread L. (mm)	Shank Dia. (mm)	Square (mm)	Order Code	Price	Order Code	Price
						TMTR11	RM	TMTR11	RM
1/4"	20.00	66.00	19.00	6.30	5.00	-20030E	35.20	-10030D	84.50
5/16"	18.00	72.00	22.00	8.00	6.30	-20033E	42.50	-10033D	104.90
3/8"	16.00	80.00	24.00	10.00	8.00	-20036E	52.80	-10036D	132.70
7/16"	14.00	85.00	25.00	8.00	6.30	-20039E	81.80	-10039D	200.60
1/2"	13.00	89.00	29.00	9.00	7.10	-20042E	85.20	-10042D	209.80
9/16"	12.00	95.00	30.00	11.20	9.00	-20045E	95.30	-10045D	237.60
5/8"	11.00	102.00	32.00	12.50	10.00	-20048E	112.30	-10048D	283.90
3/4"	10.00	112.00	37.00	14.00	11.20	-20051E	146.20	-10051D	376.50
7/8"	9.00	118.00	38.00	16.00	12.50	-20054E	210.70	-10054D	552.30
1"	8.00	130.00	45.00	18.00	14.00	-20057E	302.40	-10057D	802.30
1-1/8"	7.00	138.00	48.00	20.00	16.00	-20060E	370.30	-10060D	987.40
1-1/4"	7.00	151.00	51.00	22.40	18.00	-20063E	506.10	-10063D	1357.70
1-3/8"	6.00	162.00	57.00	25.00	20.00	-20066E	573.90	-10066D	1542.90
1-1/2"	6.00	170.00	60.00	28.00	22.40	-20069E	607.90	-10069D	1635.40
1-3/4"	5.00	187.00	67.00	31.50	25.00	-20072E	913.40	-10072D	2468.60
2"	4.50	200.00	70.00	35.50	28.00	-20075E	1049.10	-10075D	2838.90

Metric Coarse HSS Spiral Flute Taps - Nitride Finish

- Standard: ISO529
- Tolerance: H2



Spiral Point Nitride Finish - Machine Taps

Order Code TMTR10	Size	Pitch (TPI)	Overall L. (mm)	Thread L. (mm)	Shank Dia. (mm)	Square (mm)	Price RM
-30300F	M3	0.50	48.00	11.00	3.15	2.50	37.70
-30350F	M3.5	0.60	50.00	13.00	3.55	2.80	37.70
-30400F	M4	0.70	53.00	13.00	4.00	3.15	37.70
-30500F	M5	0.80	58.00	16.00	5.00	4.00	37.70
-30600F	M6	1.00	66.00	19.00	6.30	5.00	40.10
-30700F	M7	1.00	66.00	19.00	7.10	5.60	47.80
-30800F	M8	1.25	72.00	22.00	8.00	6.30	47.80
-31000F	M10	1.50	80.00	24.00	10.00	8.00	75.60
-31200F	M12	1.75	89.00	29.00	9.00	7.10	91.00

Metric Coarse HSS Circular Dies

- Standard: ISO
- Tolerance: 6H



Size (mm)	Pitch (mm)	Outside Dia. (inch)	Thk. (inch)	Order Code TMTR30	Price RM
M3.0	0.50	13/16"	1/4"	-10300G	32.40
M4.0	0.70	13/16"	1/4"	-10400G	32.40
M4.0	0.70	1"	3/8"	-10401G	35.50
M5.0	0.80	1"	3/8"	-10500G	35.50
M5.0	0.80	13/16"	1/4"	-10501G	32.40
M6.0	1.00	13/16"	1/4"	-10600G	32.40
M6.0	1.00	1"	3/8"	-10601G	35.50
M6.0	1.00	1-5/16"	7/16"	-10602G	61.70
M7.0	1.00	13/16"	1/4"	-10700G	32.40
M8.0	1.25	1"	3/8"	-10800G	35.50
M8.0	1.25	1-1/2"	1/2"	-10802G	74.10
M9.0	1.25	1"	3/8"	-10900G	35.50
M10.0	1.50	1"	3/8"	-11000G	50.90
M10.0	1.50	1-5/16"	7/16"	-11001G	77.10
M10.0	1.50	1-1/2"	1/2"	-11002G	89.50
M11.0	1.50	1-5/16"	7/16"	-11100G	77.10
M12.0	1.75	1-5/16"	7/16"	-11200G	77.10
M12.0	1.75	1-1/2"	1/2"	-11201G	89.50
M14.0	2.00	1-1/2"	1/2"	-11401G	89.50
M16.0	2.00	2"	5/8"	-11601G	200.60
M18.0	2.50	2"	5/8"	-11801G	200.60
M20.0	2.50	1-1/2"	1/2"	-12000G	89.50
M24.0	3.00	2"	5/8"	-12400G	200.60

Metric Fine HSS Circular Dies

- Standard: ISO
- Tolerance: 6H



Size (mm)	Pitch (mm)	Outside Dia. (inch)	Thk. (inch)	Order Code TMTR30	Price RM
M6.0	0.75	13/16"	1/4"	-20601G	32.40
M8.0	1.00	1"	3/8"	-20800G	35.50
M10.0	1.25	1"	3/8"	-21000G	50.90
M12.0	1.25	1-5/16"	7/16"	-21200G	77.10
M14.0	1.50	1-5/16"	7/16"	-21400G	77.10
M16.0	1.50	1-1/2"	1/2"	-21600G	89.50
M18.0	1.50	1-1/2"	1/2"	-21801G	89.50
M20.0	1.50	1-1/2"	1/2"	-22000G	89.50
M22.0	1.50	2"	5/8"	-22200G	200.60
M24.0	2.00	2"	5/8"	-22400G	200.60

UNC HSS Circular Dies

- Standard: ISO
- Tolerance: 6H



Size	Pitch (TPI)	Outside Dia. (inch)	Thk. (inch)	Order Code TMTR31	Price RM
No.2	56.00	13/16"	1/4"	-10012G	32.40
No.4	40.00	13/16"	1/4"	-10016G	32.40
No.6	32.00	13/16"	1/4"	-10020G	32.40
No.8	32.00	13/16"	1/4"	-10024G	32.40
No.10	24.00	13/16"	1/4"	-10028G	47.80
1/4"	20.00	1"	3/8"	-10033G	35.50
5/16"	18.00	1"	3/8"	-10036G	35.50
3/8"	16.00	1-5/16"	7/16"	-10041G	61.70
7/16"	14.00	1-5/16"	7/16"	-10045G	77.10
1/2"	13.00	1-5/16"	7/16"	-10048G	77.10
9/16"	12.00	1-1/2"	1/2"	-10053G	89.50
5/8"	11.00	1-1/2"	1/2"	-10056G	89.50
3/4"	10.00	1-1/2"	1/2"	-10060G	89.50
7/8"	9.00	2"	5/8"	-10064G	200.60
1"	8.00	2"	5/8"	-10068G	200.60

UNF HSS Circular Dies

- Standard: ISO
- Tolerance: 6H



Size	Pitch (TPI)	Outside Dia. (inch)	Thk. (inch)	Order Code TMTR31	Price RM
1/4"	28.00	1"	3/8"	-20033G	35.50
5/16"	24.00	1"	3/8"	-20036G	35.50
3/8"	24.00	1-5/16"	7/16"	-20041G	61.70
7/16"	20.00	1-5/16"	7/16"	-20045G	77.10
1/2"	20.00	1-1/2"	1/2"	-20049G	89.50
9/16"	18.00	1-1/2"	1/2"	-20053G	89.50
5/8"	18.00	1-1/2"	1/2"	-20056G	89.50
3/4"	16.00	1-1/2"	1/2"	-20060G	89.50
7/8"	14.00	2"	5/8"	-20064G	200.60
1"	12.00	2"	5/8"	-20068G	200.60

Tap Wrenches

- Zinc alloy material
- Can be used with tap and screw extractor
- German standard DIN 1814



Order Code	Size	For Metric Taps Range	For American Taps Range (UNC / UNF)	Price RM
TMTR70				
-00000T	No.0	M1 - M8	1/16" - 5/16"	15.10
-00010T	No.1	M1 - M10	1/16" - 3/8"	19.00
-00015T	No.1-1/2	M1 - M12	1/16" - 1/2"	19.20
-00020T	No.2	M4 - M12	3/16" - 5/8"	33.70
-00030T	No.3	M5 - M20	1/4" - 3/4"	72.00
-00040T	No.4	M9 - M27	3/8" - 1"	91.30
-00050T	No.5	M13 - M32	5/8" - 1-1/4"	143.30
-00060T	No.6	M18 - M42	3/4" - 1-1/2"	331.10
-00070T	No.7	M25 - M52	7/8" - 2"	518.00
-00080T	No.8	M25 - M70	1" - 2-7/8"	701.10

Ratchet Tap Wrenches

- Reversible
- Easy to use



Order Code	For Metric Taps Range	For American Taps Range (UNC / UNF)	Length (mm)	Price RM
TMTR71				
-00310T	M3 - M10	1/8" - 3/8"	85	39.80
-00512T	M5 - M12	7/32" - 1/2"	100	56.50

Extended type

-00310L	M3 - M10	1/8" - 3/8"	250	50.40
-00512L	M5 - M12	7/32" - 1/2"	300	55.80

32Pc UNC Tap & Die Set

- Die Stocks: 25 × 9mm
- Tap: No.1-1 / 2
- Screwdriver
- American SAE pitch gauge: 12 - 40TPI
- Hand tap (total 21pcs):
Each 3: UNC 1/8", 5/32", 3/16", 1/4", 5/16", 3/8", 1/2"
- Dies (total 7pcs):
UNC 1/8", 5/32", 3/16", 1/4", 5/16", 3/8", 1/2"

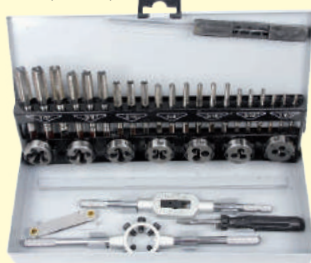

Order Code	Size (inch)	Price RM
TMTR88		
-91032N	1/8" ~ 1/2"	756.20

Die Stocks

- Zinc alloy material
- Designed to hold a range of different sizes of dies
- German standard DIN 225



Order Code	Die Outside Dia. (mm)	Die Thickness (mm)	For Dies Range	Price RM
TMTR75				
-01605D	16	5	M1 - M2.6	11.60
-02005D	20	5	M3 - M4	13.70
-02007D	20	7	M5 - M6	13.70
-0 2509D	25	9	M7 - M9	16.10
-03011D	30	11	M10 - M11	24.90
-03814D	38	14	M12 - M14	33.40
-04518D	45	18	M16 - M20	45.20
-05522D	55	22	M22 - M24	58.10
-06525D	65	25	M27 - M36	109.10
-09036D	90	36	M45 - M52	369.50
-10536D	105	36	M55 - M60	465.30
-12500D	125	\	M64 - M68	550.40
-15000D	150	\	M72	767.10

32Pc Metric Tap & Die Set

- Die Stocks: 25 × 9mm
- Tap: No.1-1 / 2
- Screwdriver
- Metric pitch gauge: 0.4 - 6.0mm
- Hand tap (total 21pc):
Each 3: M3, M4, M5, M6, M8, M10, M12
- Dies (total 7pcs):
M3, M4, M5, M6, M8, M10, M12



Order Code	Size	Price RM
TMTR88		
-80032M	M3 ~ M12	756.20

54Pc Metric Tap & Die Set

- Die Stocks (total 6 pcs):
20 × 5 mm, 20 × 7 mm, 25 × 9 mm, 30 × 11 mm, 38 × 14 mm, 45 × 18 mm
- Tap (total 2): No.1, No.3
- Screwdriver
- Metric pitch gauge: 0.4 - 6.0mm
- Hand tap (total 33pcs):
Each 3: M3, M4, M5, M6, M8, M10, M12, M14, M16, M18, M20
- Dies (total 11pcs):
M3, M4, M5, M6, M8, M10, M12, M14, M16, M18, M20



Order Code	Size	Price RM
TMTR88		
-80054M	M3 ~ M20	1689.40

HSS Metric Multi Flute Core Drills

- High-quality HSS, combined with the hierarchical cutting and low friction geometry, obtains good wear resistance and chip flow performance
- Flattened shank for use in TEMO, KENNEDY, BDS, ALFRA, RUKO, EUROBROACH drilling machines and various types of bench drill, lathes and other mechanical equipments
- Mainly used for processing steel and so on



Order Code TMCD10	Drilling Dia. (mm)	Cutting Depth (mm)	Shank Dia. (mm)	Price RM
-03012A	12	35	19	79.70
-03013A	13	35	19	79.70
-03014A	14	35	19	79.70
-03015A	15	35	19	83.90
-03016A	16	35	19	83.90
-03017A	17	35	19	90.20
-03018A	18	35	19	105.10
-03019A	19	35	19	98.50
-03020A	20	35	19	104.80
-03021A	21	35	19	119.40
-03022A	22	35	19	129.80
-03023A	23	35	19	129.80
-03024A	24	35	19	140.20
-03025A	25	35	19	146.50
-03026A	26	35	19	146.50
-03027A	27	35	19	154.80
-03028A	28	35	19	161.10
-03029A	29	35	19	161.10
-03030A	30	35	19	169.40
-03031A	31	35	19	177.80
-03032A	32	35	19	186.10
-03033A	33	35	19	190.20
-03034A	34	35	19	196.50
-03035A	35	35	19	199.00
-03036A	36	35	19	205.10
-03037A	37	35	19	205.10
-03038A	38	35	19	213.40
-03039A	39	35	19	223.50
-03040A	40	35	19	227.70
-03041A	41	35	19	235.80
-03042A	42	35	19	239.90
-03043A	43	35	19	258.30
-03044A	44	35	19	280.80
-03045A	45	35	19	291.10
-03046A	46	35	19	303.30
-03047A	47	35	19	315.60
-03048A	48	35	19	325.80
-03049A	49	35	19	325.80
-03050A	50	35	19	350.50
-03051A	51	35	19	368.70
-03052A	52	35	19	381.10
-03053A	53	35	19	391.20
-03054A	54	35	19	403.60
-03055A	55	35	19	415.80
-03056A	56	35	19	430.10
-03057A	57	35	19	440.40
-03058A	58	35	19	450.60
-03059A	59	35	19	462.90
-03060A	60	35	19	475.20

Order Code TMCD10	Drilling Dia. (mm)	Cutting Depth (mm)	Shank Dia. (mm)	Price RM
-05012A	12	50	19	94.30
-05013A	13	50	19	94.30
-05014A	14	50	19	94.30
-05015A	15	50	19	100.60
-05016A	16	50	19	100.60
-05017A	17	50	19	108.90
-05018A	18	50	19	108.90
-05019A	19	50	19	113.10
-05020A	20	50	19	121.40
-05021A	21	50	19	129.80
-05022A	22	50	19	140.20
-05023A	23	50	19	140.20
-05024A	24	50	19	150.70
-05025A	25	50	19	163.10
-05026A	26	50	19	163.10
-05027A	27	50	19	169.40
-05028A	28	50	19	177.80
-05029A	29	50	19	177.80
-05030A	30	50	19	186.10
-05031A	31	50	19	198.60
-05032A	32	50	19	196.90
-05033A	33	50	19	196.90
-05034A	34	50	19	207.20
-05035A	35	50	19	213.40
-05036A	36	50	19	225.60
-05037A	37	50	19	225.60
-05038A	38	50	19	235.80
-05039A	39	50	19	241.90
-05040A	40	50	19	246.10
-05041A	41	50	19	246.10
-05042A	42	50	19	254.20
-05043A	43	50	19	278.80
-05044A	44	50	19	293.10
-05045A	45	50	19	313.50
-05046A	46	50	19	329.80
-05047A	47	50	19	352.40
-05048A	48	50	19	366.80
-05049A	49	50	19	366.80
-05050A	50	50	19	391.20
-05051A	51	50	19	403.60
-05052A	52	50	19	430.10
-05053A	53	50	19	454.70
-05054A	54	50	19	495.60
-05055A	55	50	19	505.80
-05056A	56	50	19	516.10
-05057A	57	50	19	526.20
-05058A	58	50	19	532.40
-05059A	59	50	19	544.60
-05060A	60	50	19	557.00

Metric Tungsten Carbide Tipped Core Drills

- High-performance cemented carbide inserts, layered cuts and low-friction geometries reduce chipping edge and improve chip flow
- Flattened shank for use in TEMO, KENNEDY, BDS, ALFRA, RUKO, EUROBROACH drilling machines and various types of bench drill, lathes and other mechanical equipment
- Suitable for processing stainless steel (white steel), steel and so on



Order Code	Drilling Dia. (mm)	Cutting Depth (mm)	Shank Dia. (mm)	Price RM
TMCD20				
-03512A	12	35	19	170.00
-03513A	13	35	19	170.00
-03514A	14	35	19	170.00
-03515A	15	35	19	170.00
-03516A	16	35	19	170.00
-03517A	17	35	19	170.00
-03518A	18	35	19	170.00
-03519A	19	35	19	170.00
-03520A	20	35	19	170.00
-03521A	21	35	19	170.00
-03522A	22	35	19	170.00
-03523A	23	35	19	170.00
-03524A	24	35	19	170.00
-03525A	25	35	19	170.00
-03526A	26	35	19	206.50
-03527A	27	35	19	206.50
-03528A	28	35	19	206.50
-03529A	29	35	19	206.50
-03530A	30	35	19	206.50
-03531A	31	35	19	214.80
-03532A	32	35	19	214.80
-03533A	33	35	19	214.80
-03534A	34	35	19	214.80
-03535A	35	35	19	214.80
-03536A	36	35	19	246.00
-03537A	37	35	19	246.00
-03538A	38	35	19	246.00
-03539A	39	35	19	246.00
-03540A	40	35	19	246.00
-03541A	41	35	19	280.70
-03542A	42	35	19	280.70
-03543A	43	35	19	280.70
-03544A	44	35	19	280.70
-03545A	45	35	19	280.70
-03546A	46	35	19	337.80
-03547A	47	35	19	337.80
-03548A	48	35	19	337.80
-03549A	49	35	19	337.80
-03550A	50	35	19	337.80
-03551A	51	35	19	382.40
-03552A	52	35	19	382.40
-03553A	53	35	19	382.40
-03554A	54	35	19	382.40
-03555A	55	35	19	382.40
-03556A	56	35	19	413.60
-03557A	57	35	19	413.60
-03558A	58	35	19	413.60
-03559A	59	35	19	413.60
-03560A	60	35	19	413.60

Order Code	Drilling Dia. (mm)	Cutting Depth (mm)	Shank Dia. (mm)	Price RM
TMCD20				
-05012A	12	50	19	189.30
-05013A	13	50	19	189.30
-05014A	14	50	19	189.30
-05015A	15	50	19	189.30
-05016A	16	50	19	189.30
-05017A	17	50	19	189.30
-05018A	18	50	19	189.30
-05019A	19	50	19	189.30
-05020A	20	50	19	189.30
-05021A	21	50	19	189.30
-05022A	22	50	19	189.30
-05023A	23	50	19	189.30
-05024A	24	50	19	189.30
-05025A	25	50	19	189.30
-05026A	26	50	19	206.50
-05027A	27	50	19	206.50
-05028A	28	50	19	206.50
-05029A	29	50	19	206.50
-05030A	30	50	19	206.50
-05031A	31	50	19	248.40
-05032A	32	50	19	248.40
-05033A	33	50	19	248.40
-05034A	34	50	19	248.40
-05035A	35	50	19	248.40
-05036A	36	50	19	284.40
-05037A	37	50	19	284.40
-05038A	38	50	19	284.40
-05039A	39	50	19	284.40
-05040A	40	50	19	284.40
-05041A	41	50	19	324.40
-05042A	42	50	19	324.40
-05043A	43	50	19	324.40
-05044A	44	50	19	324.40
-05045A	45	50	19	324.40
-05046A	46	50	19	390.50
-05047A	47	50	19	390.50
-05048A	48	50	19	390.50
-05049A	49	50	19	390.50
-05050A	50	50	19	390.50
-05051A	51	50	19	442.00
-05052A	52	50	19	442.00
-05053A	53	50	19	442.00
-05054A	54	50	19	442.00
-05055A	55	50	19	442.00
-05056A	56	50	19	485.80
-05057A	57	50	19	485.80
-05058A	58	50	19	485.80
-05059A	59	50	19	485.80
-05060A	60	50	19	485.80

Order Code	Drilling Dia. (mm)	Cutting Depth (mm)	Shank Dia. (mm)	Price RM
TMCD20				
-07518A	18	75	19	298.10
-07519A	19	75	19	298.10
-07520A	20	75	19	298.10
-07521A	21	75	19	298.10
-07522A	22	75	19	298.10
-07523A	23	75	19	298.10
-07524A	24	75	19	298.10
-07525A	25	75	19	298.10
-07526A	26	75	19	323.90
-07527A	27	75	19	323.90
-07528A	28	75	19	323.90
-07529A	29	75	19	323.90
-07530A	30	75	19	323.90
-07531A	31	75	19	391.20
-07532A	32	75	19	391.20
-07533A	33	75	19	391.20
-07534A	34	75	19	391.20
-07535A	35	75	19	391.20
-07536A	36	75	19	451.30
-07537A	37	75	19	451.30
-07538A	38	75	19	451.30
-07539A	39	75	19	451.30
-07540A	40	75	19	451.30
-07541A	41	75	19	517.70
-07542A	42	75	19	517.70
-07543A	43	75	19	517.70
-07544A	44	75	19	517.70
-07545A	45	75	19	517.70
-07546A	46	75	19	621.60
-07547A	47	75	19	621.60
-07548A	48	75	19	621.60
-07549A	49	75	19	621.60
-07550A	50	75	19	621.60
-07551A	51	75	19	694.50
-07552A	52	75	19	694.50
-07553A	53	75	19	694.50
-07554A	54	75	19	694.50
-07555A	55	75	19	694.50
-07556A	56	75	19	758.30
-07557A	57	75	19	758.30
-07558A	58	75	19	758.30
-07559A	59	75	19	758.30
-07560A	60	75	19	758.30

7Pc Metric HSS Core Drill Kit in Plastic Box - 30mm Cutting Depth

- Size (cutting depth 30mm): 14,16,18, 20,22,24 mm
- Pilot Pin: 1pc Size: 6.34/5.3 x 77mm



Order Code	Size mm	Price RM
-83007M	14 ~ 24	876.20

7Pc Metric T.C.T. Core Drill Kit in Plastic Box - 35mm Cutting Depth

- Size (cutting depth 35mm): 14,16,18,20,22mm
- Pilot Pin: 2pc Size: 6.34/5.3 x 90mm 7.98 x 105mm



Order Code	Size mm	Price RM
- 83507M	14 ~ 22	1119.30

7Pc Metric HSS Core Drill Kit in Plastic Box - 50mm Cutting Depth

- Size (cutting depth 50mm): 14,16,18, 20,22,24 mm
- Pilot Pin: 1pc Size: 6.34/5.3 x 102mm



Order Code	Size mm	Price RM
-85007M	14 ~ 24	994.90

7Pc Metric T.C.T. Core Drill Kit in Plastic Box - 50mm Cutting Depth

- Size (cutting depth 50mm): 14,16,18,20,22mm
- Pilot Pin: 2pc Size: 6.34/5.3 x 90mm 7.98 x 105mm



Order Code	Size mm	Price RM
-85007M	14 ~ 22	1278.80

7Pc Inch HSS Core Drill Kit in Plastic Box - 1" Cutting Depth

- Size (cutting depth 1"):
9/16", 5/8", 3/4", 7/8", 15/16", 1"
- Pilot Pin: 1pc Size: 6.34/5.3 x 77mm



Order Code	Size inch	Price RM
-90107N	9/16" ~ 1"	907.00

7Pc Inch T.C.T. Core Drill Kit in Plastic Box - 1-3/8" Cutting Depth

- Size (cutting depth 1-3/8"):
9/16", 5/8", 3/4", 7/8", 15/16"
- Pilot Pin: 2pc Size: 6.34/5.3 x 102mm 7.98 x 105mm



Order Code	Size inch	Price RM
-90107N	9/16" ~ 15/16"	1197.50

Morse Taper Arbors - Screw Clamping, Internal Coolant

- Fitted with Weldon Shank, Quick change shank (Nitto Shank)
- Suitable for use in magnetic drilling machines, ordinary drilling and milling machine use
- Internal cooling type



Order Code	Shank Diameter	Morse Taper	Overall L. (mm)	Suitable for Cutting Depth (mm)	Price RM
TMCD70					
-19168A	19.05mm (3/4")	MT2	168	50	592.60
-19187A	19.05mm (3/4")	MT3	187	50	619.90
-19203A	19.05mm (3/4")	MT3	203	75	695.60
-32250A	31.75mm (1-1/4")	MT4	250	100	1140.50
-32269A	31.75mm (1-1/4")	MT5	269	100	1215.10

Morse Taper Arbors - Screw Clamping, External Coolant

- Fitted with Weldon Shank, Quick change shank (Nitto Shank)
- Suitable for use in magnetic drilling machine, ordinary drilling and milling machine
- External cooling type



Order Code	Shank Diameter	Morse Taper	Overall L. (mm)	Suitable for Cutting Depth (mm)	Price RM
TMCD71					
-19162A	19.05mm (3/4")	MT2	162	50	262.80
-19176A	19.05mm (3/4")	MT3	176	50	281.50

Pilot Pins



Order Code	Size(mm)	For Magnetic Core Drill Type	For Magnetic Core Drill Diameter Range(mm)	Fit Magnetic Core Drill Cutting Depth	Price RM
TMCD72					
-63077P	6.34/5.3 × 77	HSS	12-60	25mm (1")	12.60
-63090P	6.34/5.3 × 90	T.C.T. Solid Carbide Tooth	12-17	35mm (1-3/8")	13.10
-63102P	6.34/5.3 × 102	HSS	12-60	50mm (2")	17.00
		T.C.T. Solid Carbide Tooth	12-17		
-80090P	7.98 × 90	T.C.T. Solid Carbide Tooth	18-60	35mm (1-3/8")	18.10
-80105P	7.98 × 105	T.C.T. Solid Carbide Tooth	18-60	50mm (2")	20.80
-80130P	7.98 × 130	HSS	14-60	75mm (3")	23.60
		T.C.T. Solid Carbide Tooth	18-60		
-80155P	7.98 × 155	HSS	14-60	100mm (4")	26.50
		T.C.T. Solid Carbide Tooth	18-60		

11Pc T.C.T. Holesaw Kit

- 7 pieces Holesaw, Sizes are as follows: 19mm, 22mm, 25mm, 29mm, 35mm, 44mm, 51mm
- Holesaw: 1 (6.0mm)
- Spring: 1 piece
- Hex wrench: 2 pieces
- EVA box packaging



Price RM 1196.30

Order Code: TMCD40- 80111M

8Pc Interchangeable HSS Holesaw Kit

- 5 pieces Holesaw, Sizes are as follows: 16mm, 20mm, 22mm, 25mm, 30mm
- K1 Arbors: 2 pieces
- Hex wrench: 1 piece
- EVA box packaging

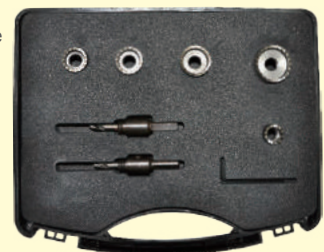

Price RM 354.40

Order Code: TMCD30- 80108M

Tungsten Carbide Tipped Holesaws

- Suitable for processing a variety of sheet and pipe, such as steel, stainless steel, cast iron plate, plastic plate and other plates
- Drill and spring configuration, easy for work piece positioning and waste dropped
- Unique chip flute and chip hole design enable high working efficiency
- One piece design for body, knife handle, blade ensures stable drilling, reduce the resonance and tremor
- Processing depth up to 28mm, thick plate and thick walls both can be machined metallic surface material



Order Code TMCD40	Cutting Dia. (mm)	Cutting Dia. (inch)	Overall L. (mm)	Depth (mm)	Shank Dia. (mm)	Price RM
-28014K	14	9/16"	107	25	10	102.70
-28016K	16	5/8"	107	25	10	102.70
-28017K	17	11/16"	107	25	10	102.70
-28019K	19	3/4"	107	25	10	102.70
-28020K	20	25/32"	107	25	10	102.70
-28021K	21	13/16"	107	25	10	111.40
-28022K	22	7/8"	107	25	10	111.40
-28024K	24	15/16"	107	25	10	111.40
-28025K	25	1"	107	25	10	111.40
-28027K	27	1-1/16"	107	25	10	122.30
-28029K	29	1-1/8"	107	25	10	122.30
-28030K	30	1-3/16"	107	25	10	122.30
-28032K	32	1-1/4"	107	25	10	132.00
-28033K	33	1-5/16"	107	25	10	132.00
-28035K	35	1-3/8"	107	25	10	132.00
-28037K	37	1-7/16"	107	25	10	158.30
-28038K	38	1-1/2"	107	25	10	158.30
-28040K	40	1-9/16"	107	25	10	158.30
-28041K	41	1-5/8"	107	25	10	179.90
-28043K	43	1-11/16"	107	25	10	179.90
-28044K	44	1-3/4"	107	25	10	179.90
-28046K	46	1-13/16"	107	25	10	188.60
-28048K	48	1-7/8"	107	25	10	188.60
-28051K	51	2"	107	25	10	216.00
-28052K	52	2-1/16"	107	25	10	216.00
-28054K	54	2-1/8"	107	25	10	216.00
-28057K	57	2-1/4"	107	25	10	264.90
-28059K	59	2-5/16"	107	25	10	264.90
-28060K	60	2-3/8"	107	25	10	264.90
-28065K	65	2-9/16"	107	25	10	290.40
-28070K	70	2-3/4"	135	25	13	428.00
-28075K	75	3"	135	25	13	359.20
-28080K	80	3-1/8"	135	25	13	378.40
-28085K	85	3-3/8"	135	25	13	410.30
-28090K	90	3-1/2"	135	25	13	442.80
-28095K	95	3-3/4"	135	25	13	479.80
-28100K	100	3-7/8"	135	25	13	512.70
-28105K	105	4-1/8"	135	25	13	568.40
-28110K	110	4-3/8"	135	25	13	568.40
-28115K	115	4-1/2"	135	25	13	602.50
-28120K	120	4-3/4"	135	25	13	602.50
-28125K	125	5"	135	25	13	742.60
-28130K	130	5-1/4"	135	25	13	742.60
-28140K	140	5-1/2"	135	25	13	782.20
-28152K	152	6"	135	25	13	881.60

HSS Holesaws

- Suitable for processing a variety of sheet and pipe, such as steel, stainless steel, cast iron, plastic plates and other plates
- Drill and spring configuration, easy for work piece positioning and waste dropped
- Unique chip flute and chip hole design enable high working efficiency
- One piece design for body, knife handle, blade ensures stable drilling, reduce the resonance and tremor



Order Code TMCD30	Cutting Dia. (mm)	Overall L. (mm)	Depth (mm)	Shank Dia. (mm)	Price RM
-07014A	14	70	5	10	23.90
-07015A	15	70	5	10	23.90
-07016A	16	70	5	10	23.90
-07017A	17	70	5	10	26.20
-07018A	18	70	5	10	26.20
-07019A	19	70	5	10	28.50
-07020A	20	70	5	10	30.90
-07021A	21	70	5	10	30.90
-07022A	22	70	5	10	33.20
-07023A	23	70	5	10	33.20
-07024A	24	70	5	10	35.50
-07025A	25	70	5	10	40.10
-07026A	26	70	5	10	40.10
-07027A	27	70	5	10	44.70
-07028A	28	70	5	10	44.70
-07029A	29	70	5	10	44.70
-07030A	30	70	5	10	47.10
-07032A	32	70	5	10	49.40
-07033A	33	70	5	10	51.70
-07035A	35	70	5	10	51.70
-07036A	36	70	5	10	51.70
-07038A	38	70	5	10	56.30
-07039A	39	70	5	10	56.30
-07040A	40	70	5	13	63.30
-07042A	42	70	5	13	65.60
-07045A	45	70	5	13	70.20
-07048A	48	70	5	13	81.80
-07050A	50	70	5	13	86.40
-07053A	53	70	5	13	91.00
-07055A	55	70	5	13	93.30
-07060A	60	70	5	13	102.60
-07065A	65	70	5	13	109.50
-07070A	70	70	5	13	167.50
-07075A	75	70	5	13	179.10
-07080A	80	70	5	13	190.70
-07085A	85	70	5	13	202.20
-07090A	90	70	5	13	216.10
-07100A	100	70	5	13	249.10

Bi-Metal Holesaws

- Suitable for processing a variety of plates thickness within 4.5mm such as steel, stainless steel, cast iron, plastic board, wood and other plates
- EVA box packaging



Order Code	Cutting Dia.		Arbors	Cutting Depth	Price
TMCD50	(mm)	(inch)	Type	(mm)	RM
-38014B	14	9/16"	K1, K4	38	9.90
-38016B	16	5/8"	K1, K4	38	11.00
-38017B	17	11/16"	K1, K4	38	12.50
-38019B	19	3/4"	K1, K4	38	12.90
-38020B	20	25/32"	K1, K4	38	13.30
-38021B	21	13/16"	K1, K4	38	14.00
-38022B	22	7/8"	K1, K4	38	14.90
-38024B	24	15/16"	K1, K4	38	15.50
-38025B	25	1"	K1, K4	38	15.80
-38027B	27	1-1/16"	K1, K4	38	17.20
-38029B	29	1-1/8"	K1, K4	38	19.40
-38030B	30	1-3/16"	K1, K4	38	20.10
-38032B	32	1-1/4"	K2, K10	38	20.90
-38033B	33	1-5/16"	K2, K10	38	21.60
-38035B	35	1-3/8"	K2, K10	38	22.30
-38037B	37	1-7/16"	K2, K10	38	22.70
-38038B	38	1-1/2"	K2, K10	38	23.90
-38040B	40	1-9/16"	K2, K10	38	24.40
-38041B	41	1-5/8"	K2, K10	38	24.40
-38043B	43	1-11/16"	K2, K10	38	25.50
-38044B	44	1-3/4"	K2, K10	38	25.90
-38046B	46	1-13/16"	K2, K10	38	26.80
-38048B	48	1-7/8"	K2, K10	38	27.90
-38051B	51	2"	K2, K10	38	29.30
-38052B	52	2-1/16"	K2, K10	38	30.00
-38054B	54	2-1/8"	K2, K10	38	31.10
-38057B	57	2-1/4"	K2, K10	38	31.70
-38059B	59	2-5/16"	K2, K10	38	33.10
-38060B	60	2-3/8"	K2, K10	38	33.90
-38064B	64	2-1/2"	K2, K10	38	36.00
-38065B	65	2-9/16"	K2, K10	38	36.70
-38067B	67	2-5/8"	K2, K10	38	38.50
-38068B	68	2-11/16"	K2, K10	38	39.30
-38070B	70	2-3/4"	K2, K10	38	40.40
-38073B	73	2-7/8"	K2, K10	38	42.50
-38076B	76	3"	K2, K10	38	43.90
-38079B	79	3-1/8"	K2, K10	38	45.40
-38083B	83	3-1/4"	K2, K10	38	47.40
-38086B	86	3-3/8"	K2, K10	38	48.60
-38089B	89	3-1/2"	K2, K10	38	52.10
-38092B	92	3-5/8"	K2, K10	38	53.20
-38095B	95	3-3/4"	K2, K10	38	55.30
-38098B	98	3-7/8"	K2, K10	38	56.40
-38102B	102	4"	K2, K10	38	58.60
-38105B	105	4-1/8"	K2, K10	38	61.80
-38108B	108	4-1/4"	K2, K10	38	62.70
-38111B	111	4-3/8"	K2, K10	38	64.90
-38114B	114	4-1/2"	K2, K10	38	68.30
-38121B	121	4-3/4"	K2, K10	38	71.50
-38127B	127	5"	K2, K10	38	75.70
-38133B	133	5-1/4"	K2, K10	38	80.70
-38140B	140	5-1/2"	K2, K10	38	85.60
-38146B	146	5-3/4"	K2, K10	38	88.10
-38152B	152	6"	K2, K10	38	91.50
-38160B	160	6-19/64"	K2, K10	38	101.30
-38168B	168	6-5/8"	K2, K10	38	108.60
-38177B	177	6-31/32"	K2, K10	38	117.00
-38200B	200	7-7/8"	K2, K10	38	134.10

Bi-Metal Holesaw Kits

- For use at variety of industrial applications, maintenance and so on

9Pcs Set

- Contents:
- 6pcs holesaws, Sizes are as follows: 16, 20, 25, 32, 40, 51 (mm)
 - Connectors: nuts and washers
 - Arbors: 2 pieces (K1, K2)

16Pcs Set

- Contents:
- 11pcs holesaws, Sizes are as follows: 19, 22, 25, 32, 35, 38, 44, 51, 57, 64, 76 (mm)
 - Arbors: 2 (K1, K10)
 - Extension bar: 1 (300mm)
 - Drill: 1 (6.35mm)
 - Spring: 1 piece

19Pcs Set

- Contents:
- 13 pcs Holesaws, Sizes are as follows: 19, 22, 25, 29, 32, 35, 38, 44, 51, 57, 64, 76, 83 (mm)
 - Arbors: 2 (K1, K10)
 - Extension bar: 1 (300mm)
 - Drill: 2 (6.35mm)
 - Spring: 1 piece



Order Code	Pcs	Price RM
TMCD50		
-80109M	9	250.70
-80116M	16	472.20
-80119M	19	600.70

Arbors

Types	Order code TMCD55	Arbors	Fitted Hole For Holesaws Size (mm)	Shank diameter	Shank Type	Price RM
	-10004K	K4	14-30	1/4"	Round	14.70
	-20001K	K1	14-30	3/8"	Hexagon	14.90
	-20002K	K2	32-210	3/8"	Hexagon	35.70
	-20010K	K10	32-210	7/16"	Hexagon	35.70



TEMO[®]

Abrasives

www.temomalaysia.com

Reinforced Resin Grinding Discs (T27)

- Made of high-quality genuine sand, use of resin binder with advanced technology and professional automation equipment
- Use for cleaning, welding polished, remove burrs, rust, paint and etc
- Use with professional angle grinder to achieve efficient and high-quality processing
- Max Speed: 80m/sec
- Comply with international standards: EN12413
- 5 pieces per pack



T27

Order Code TMDC21	Grit (mm)	Diameter (mm)	Thickness (mm)	Bore Diameter (mm)	Price RM
-30501E	A24RBF	100	4	9.6	4.30
-50501E	A24RBF	125	6	22	8.50
-60501E	A24RBF	150	6	22	9.50
-70501E	A24RBF	180	6	22	11.30

Reinforced Resin Cutting Discs (T41)

- Made of high-quality genuine sand, use of resin binder with advanced technology and professional automation equipment
- Use for cutting, grooving, and fixed cut, section cut and so on
- Max Speed: 80m/sec
- Comply with international standards: EN12413
- 5 pieces per pack

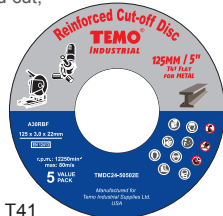

T41

Order Code TMDC24	Grit (mm)	Diameter (mm)	Thickness (mm)	Bore Diameter (mm)	Price RM
-30502E	A30RBF	100	3	16	3.20
-50502E	A30RBF	125	3	22	4.10
-60502E	A30RBF	150	3	22	5.50
-70502E	A30RBF	180	3	22	7.20
-90502E	A30RBF	335	3	25.4	24.50

Reinforced Resin Extra-Thin Cutting Discs for Stainless Steel (T41)

- Made of high-quality genuine sand, use of resin binder with advanced technology and professional automation equipment
- For stainless steel cutting, iron, chlorine, sulfur content ≤ 0.2%, prevent material changes of the stainless steel workpiece that being processed especially suitable for strict requirements of the stainless steel material areas such as nuclear power industry
- Max Speed: 80m/sec
- Comply with international standards: EN12413
- 5 pieces per pack

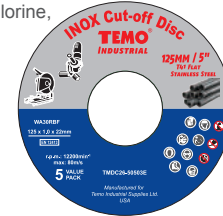

T41

Order Code TMDC26	Grit (mm)	Diameter (mm)	Thickness (mm)	Bore Diameter (mm)	Price RM
-30503E	WA60RBF	100	1.0	16	3.30
-50503E	WA60RBF	125	1.0	22	3.80
-60503E	WA60RBF	150	1.0	22	5.60
-70503E	WA60RBF	180	1.6	22	6.60

Nylon Clean & Strip CNS wheels

Color Classification:

- Black** - Universal quick grinding wheels: remove the general coating and polishing surface, can be used for stainless steel, mild steel, aluminum, plastic, cement, wood and stone surface
- Blue** - Medium hard type & high-efficient grinding wheels: higher hardness and stronger than black type, good for dark rust removing & corroded surfaces polishing, concrete surface cleaning. Suitable for ships, bridges and other industries
- Purple** - High-strength grinding wheels: the highest hardness, longest life expectancy, removal good for removing severe rust and polishing severely corroded surface

CNS Wheels - Fiberglass Backed



Outer Dia.(mm)	Aperture (mm)	Black		Blue		Purple	
		Order Code TMGW10	Price RM	Order Code TMGW10	Price RM	Order Code TMGW10	Price RM
100	16	-31010B	22.50	-32010B	24.70	-33010B	24.70
125	22	-51010B	32.40	-52010B	34.70	-53010B	34.70
150	22	-61010B	56.00	-62010B	60.70	-63010B	60.70
180	22	-71010B	60.70	-72010B	66.60	-73010B	66.60

CNS Wheels - Flat

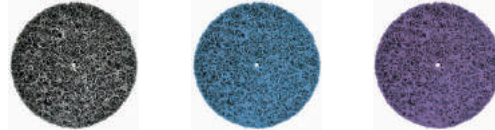

Outer Dia.(mm)	Aperture (mm)	Black		Blue		Purple	
		Order Code TMGW11	Price RM	Order Code TMGW11	Price RM	Order Code TMGW11	Price RM
75	6	-21010C	11.10	-22010C	12.30	-23010C	12.30
100	12	-31010C	16.10	-32010C	19.00	-33010C	19.00
125	12	-51010C	28.30	-52010C	31.20	-53010C	31.20
150	16	-61010C	40.70	-62010C	45.30	-63010C	45.30
180	22	-71010C	59.50	-72010C	66.60	-73010C	66.60
200	22	-81010C	78.40	-82010C	83.10	-83010C	83.10

CNS Wheels - Shaft Mounted



Outer Dia.(mm)	Shank Dia.(mm)	Black		Blue		Purple	
		Order Code TMGW12	Price RM	Order Code TMGW12	Price RM	Order Code TMGW12	Price RM
50	6	-01010D	6.70	-02010D	7.60	-03010D	7.60
75	6	-21010D	13.00	-22010D	13.80	-23010D	13.80
100	6	-31010D	18.00	-32010D	20.60	-33010D	20.60
125	6	-41010D	30.80	-42010D	33.10	-43010D	33.10

Fiber Discs

- Made of Steel paper as the substrate with consolidation of synthetic resin and abrasive.
- Use with the pneumatic or power angle grinder to remove rust, paint, burrs, welds on metallic or a variety of non-metallic surface
- Widely used in shipbuilding, aviation, locomotives, bridges, construction and decoration industries



Zirconium Grade Fiber Discs

- Especially suitable for all kinds of metal, stainless steel, weld, hardwood grinding, etc.
- 25 pieces per pack

Hole Groove	Outer Dia. (mm)	Aperture (mm)	Thickness (mm)	Grit P60 Order Code TMDC30	Price RM	Grit P80 Order Code TMDC30	Price RM	Grit P120 Order Code TMDC30	Price RM
Round Hole									
	100	16	0.8	-31061Z	3.40	-31081Z	3.30	-31121Z	3.30
	115	22	0.8	-41061Z	3.80	-41081Z	3.80	-41121Z	3.80
	125	22	0.8	-51061Z	4.70	-51081Z	4.70	-51121Z	4.70
	150	22	0.8	-61061Z	6.60	-61081Z	6.60	-61121Z	6.60
	180	22	0.8	-71061Z	7.80	-71081Z	7.80	-71121Z	7.80



Alumium Oxide Fiber Discs

- Particularly suitable for general metal, hardwood, furniture grinding and so on
- 25 pieces per pack

Hole Groove	Outer Dia. (mm)	Aperture (mm)	Thickness (mm)	Grit P60 Order Code TMDC31	Price RM	Grit P80 Order Code TMDC31	Price RM	Grit P120 Order Code TMDC31	Price RM
Round Hole									
	100	16	0.8	-31061G	2.00	-31081G	2.00	-31121G	2.00
	115	22	0.8	-41061G	2.50	-41081G	2.50	-41121G	2.50
	125	22	0.8	-51061G	3.00	-51081G	3.00	-51121G	3.00
	150	22	0.8	-61061G	4.10	-61081G	4.10	-61121G	4.10
	180	22	0.8	-71061G	4.80	-71081G	4.80	-71121G	4.80



Silicon Carbide Fiber Discs

- Particularly suitable for general metal, hardwood, furniture grinding and so on
- 25 pieces per pack

Hole Groove	Outer Dia. (mm)	Aperture (mm)	Thickness (mm)	Grit P60 Order Code TMDC32	Price RM	Grit P80 Order Code TMDC32	Price RM	Grit P120 Order Code TMDC32	Price RM
Round Hole									
	100	16	0.8	-31061C	2.10	-31081C	2.10	-31121C	2.10
	115	22	0.8	-41061C	2.60	-41081C	2.60	-41121C	2.60
	125	22	0.8	-51061C	3.20	-51081C	3.20	-51121C	3.20
	150	22	0.8	-61061C	4.30	-61081C	4.30	-61121C	4.30
	180	22	0.8	-71061C	5.10	-71081C	5.10	-71121C	5.10



Aluminium Oxide Quick Change Discs

- Alumina oxide abrasive disc with quick & easy change screw fitting
- Applications: metal welding, welding burrs, dirt removal; clear all kinds of surface coatings, protective varnish and insulating paint such as bodywork; metal surface cleaning and rust prevention; cleaning on injection shaft of the injection molding machine; concrete wallboard stain removal; rocket engine residual fuel, rubber gasket removal, cylinder rings cleaning; cleaning and maintenance of plant equipments
- Applicable industries and jobs: metal processing, such as sheet metal coating of automobiles, motorcycles, metal stamping, die casting parts, instrumentation, bicycle parts, textile machinery, medical equipment parts, tools, knives, pen parts, household hardware, plumbing equipment, stainless steel tableware, stainless steel plate, golf head, electric vacuum products surface fi nishing, deburring, rounding and mirror polishing
- 100 pieces per pack



Order Code TMDC22	Diameter (mm)	Grit	Price/100 RM
-03808A	38	P80	224.50
-03810A	38	P100	224.50
-03812A	38	P120	224.50
-03818A	38	P180	224.50
-05003A	50	P36	374.10
-05006A	50	P60	307.50
-05008A	50	P80	262.60
-05010A	50	P100	262.60
-05012A	50	P120	262.60
-05018A	50	P180	262.60
-07503A	75	P36	673.50
-07506A	75	P60	623.50
-07508A	75	P80	623.50
-07510A	75	P100	623.50
-07512A	75	P120	573.60
-07518A	75	P180	573.60

Quick Change Surface Conditioning Discs (Nylon)

- Suitable for grinding narrow line & small area to reduce being grinded areas and avoid the un-necessary correction, easy & quick disc changing
- Suitable for all kinds of metal castings, welds, burrs grinding and rust removing, trimming
- Quick change nylon screw fitting
- 10pcs per pack



Order Code TMDC21	Diameter mm	Colour	Grade	Grit	Price/10 RM
-11010A	50	Brown	Aluminum Oxide	Coarse	71.10
-12010A		Red	Aluminum Oxide	Medium	71.10
-13010A		Blue	Aluminum Oxide	Fine	71.10
-14010A		Grey	Silicon Carbide	X-Fine	71.10
-21010A	75	Brown	Aluminum Oxide	Coarse	123.00
-22020A		Red	Aluminum Oxide	Medium	123.00
-23030A		Blue	Aluminum Oxide	Fine	123.00
-24040A		Grey	Silicon Carbide	X-Fine	123.00

Arbors with backing pad

Order Code TMDC00	Diameter mm	Shank Diameter mm	Price RM
-60050P	50	6	11.10
-60075P	75	6	14.70

Surface Conditioning Discs (Hook & Loop)

- Suitable for grinding narrow line & small area to reduce being grinded areas and avoid the un-necessary correction
- Suitable for all kinds of metal castings, weld, burr grinding and rust removal, trimming process
- 10pcs per pack



Order Code TMDC20	Diameter mm	Colour	Grade	Grit	Price/10 RM
-41001A	115	Brown	Aluminum Oxide	Coarse	138.50
-42002A		Red	Aluminum Oxide	Medium	138.50
-43003A		Blue	Aluminum Oxide	Fine	138.50
-44004A		Grey	Silicon Carbide	X-Fine	138.50
-51001A	125	Brown	Aluminum Oxide	Coarse	156.50
-52002A		Red	Aluminum Oxide	Medium	156.50
-53003A		Blue	Aluminum Oxide	Fine	156.50
-54004A		Grey	Silicon Carbide	X-Fine	156.50
-61001A	150	Brown	Aluminum Oxide	Coarse	226.70
-62002A		Red	Aluminum Oxide	Medium	226.70
-63003A		Blue	Aluminum Oxide	Fine	226.70
-64004A		Grey	Silicon Carbide	X-Fine	226.70
-81001A	200	Brown	Aluminum Oxide	Coarse	395.10
-82002A		Red	Aluminum Oxide	Medium	395.10
-83003A		Blue	Aluminum Oxide	Fine	395.10
-84004A		Grey	Silicon Carbide	X-Fine	395.10

Hand Pads

Colour	Abrasive	Grit	Features
White	without abrasive	/	Cleaning cloth, white colour, without abrasive, the soft non-woven fibers gently clean most product surfaces
Green	Aluminium Oxide	Fine	With finer artificial fibers for cleaning and fine grinding more economical products
Dark Brown	Aluminium Oxide	Fine	With medium flexibility for quickly polished, resistant to both water & solvents, more end-users like to use
Grey	Silicon Carbide	X-Fine	Final brightening scouring cloth, for high-quality surface fine grinding
Black	Silicon Carbide	Medium	Perform good flexibility when use on irregular surface, the products are designed for a variety of uses
Camel	Aluminium Oxide	Coarse	Design for heavy industry use in the plane surface polishing, deburring and cleaning, used to replace steel wool, wire brush, flap wheels and similar products

- Suitable for manual and machine use.
- Dry or wet grinding
- Brings uniform, smooth & beautiful surface effects
- Does not change the shape of the workpiece surface, has good applicability
- Size: 155 x 225mm
- 10pcs per pack



Order Code TMDC60	Colour	Grit	Price/10 RM
-00010B	White	/	48.00
-03020B	Green	Fine	55.00
-03030B	Dark Brown	Fine	55.00
-05040B	Grey	X-Fine	55.00
-02050B	Black	Medium	70.00
-01060B	Camel	Coarse	70.00

Non-Woven Flap Wheels

- Suitable for work-piece inner circle and handcraft fine polishing. Applied to metallic and non-metallic variety of complex surface and deep hole polishing and finishing
- 5pcs per pack

Finishing Wheels
- General Type
Mainly used for polishing, deburring



Interleaved
Wheels
- Sanding
Cloth Type
Mainly used for roughing, rust removal



General Type		Sanding Cloth Type		Dia. (mm)	THK (mm)	Shank Dia. (mm)	Max Speed (r/min)	Grit
Order Code	Price RM	Order Code	Price RM					
TMGW10		TMGW11						
-15025A	10.50	-25025A	11.90	50	25	6	11000	Coarse
-15025B	10.50	-25025B	11.90					Medium
-15025C	10.50	-25025C	11.90					Fine
-15050A	15.20	-25050A	16.10	50	50	6	11000	Coarse
-15050B	15.20	-25050B	16.10					Medium
-15050C	15.20	-25050C	16.10					Fine
-17525A	19.40	-27525A	20.80	75	25	6	8000	Coarse
-17525B	19.40	-27525B	20.80					Medium
-17525C	19.40	-27525C	20.80					Fine
-17550A	24.10	-27550A	26.50	75	50	6	8000	Coarse
-17550B	24.10	-27550B	26.50					Medium
-17550C	24.10	-27550C	26.50					Fine

Flap Wheels

- Manufactured from special quality industrial cloth
- Sharp & strong grinding
- Applied to a variety of metal and non-metallic surface grinding & polishing, deep-hole polishing and fine finishing
- For polishing the inner & outer surface of stainless steel tube or edge deburring
- 10pcs per pack



Dia. (mm)	THK (mm)	Shank Dia. (mm)	Grit P60		Grit P80		Grit P120	
			Order Code TMGW20	Price RM	Order Code TMGW20	Price RM	Order Code TMGW20	Price RM
25	10	3	-12510A	6.50	-12510B	6.50	-12510C	6.50
30	10	3	-13010A	7.00	-13010B	7.00	-13010C	7.00
30	15	3	-13015A	7.50	-13015B	7.50	-13015C	7.50
30	15	6	-13016A	8.50	-13016B	8.50	-13016C	8.50
25	25	6	-12525A	9.50	-12525B	9.50	-12525C	9.50
30	25	6	-13025A	11.00	-13025B	11.00	-13025C	11.00
30	30	6	-13030A	12.50	-13030B	12.50	-13030C	12.50
40	10	6	-14010A	12.50	-14010B	12.50	-14010C	12.50
40	15	6	-14015A	13.00	-14015B	13.00	-14015C	13.00
40	20	6	-14020A	14.00	-14020B	14.00	-14020C	14.00
40	25	6	-14025A	16.00	-14025B	16.00	-14025C	16.00
40	50	6	-14050A	17.00	-14050B	17.00	-14050C	17.00
50	25	6	-15025A	16.00	-15025B	16.00	-15025C	16.00
50	50	6	-15050A	19.50	-15050B	19.50	-15050C	19.50
60	20	6	-16020A	18.00	-16020B	18.00	-16020C	18.00
60	25	6	-16025A	20.00	-16025B	20.00	-16025C	20.00
60	50	6	-16050A	24.00	-16050B	24.00	-16050C	24.00
80	25	6	-18025A	23.00	-18025B	23.00	-18025C	23.00
80	50	6	-18050A	30.00	-18050B	30.00	-18050C	30.00

T27 Flap Discs

- Suitable for cleaning up welds and metal products finishing
- Suitable for irregular surface polishing
- Flat-type blinds disc suitable for surface grinding and polishing
- 5pcs per pack

Alumium Oxide

For general steel use



Zirconium

For stainless steel use

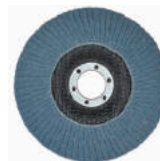

Silicon Carbide

For glass, stone use



Dia. (mm)	Aperture (mm)	Grit P40		Grit P60		Grit P80		Grit P120	
		Order Code TMDC70	Price RM	Order Code TMDC70	Price RM	Order Code TMDC70	Price RM	Order Code TMDC70	Price RM
Alumium Oxide Grit									
100	16	-30410G	7.30	-30610G	7.30	-30810G	7.30	-31210G	7.30
125	22	-50411G	10.40	-50611G	10.40	-50811G	10.40	-51211G	10.40
150	22	-60412G	19.10	-60612G	19.10	-60812G	19.10	-61212G	19.10
180	22	-70413G	23.60	-70613G	23.60	-70813G	23.60	-71213G	23.60
Zirconium Grit									
100	16	-30410Z	14.90	-30610Z	14.90	-30810Z	14.90	-31210Z	14.90
125	22	-50411Z	21.00	-50611Z	21.00	-50811Z	21.00	-51211Z	21.00
150	22	-60412Z	34.90	-60612Z	34.90	-60812Z	34.90	-61212Z	34.90
180	22	-70413Z	43.60	-70613Z	43.60	-70813Z	43.60	-71213Z	43.60
Zirconium Grit									
100	16	-30410C	10.70	-30610C	10.70	-30810C	10.70	-31210C	10.70
125	22	-50411C	14.60	-50611C	14.60	-50811C	14.60	-51211C	14.60
150	22	-60412C	28.40	-60612C	28.40	-60812C	28.40	-61212C	28.40
180	22	-70413C	34.80	-70613C	34.80	-70813C	34.80	-71213C	34.80

Felt Flap Wheels

- Made of Australian wool material, high purity, no impurities, good flexibility, moderate hardness
- Applied together with different grit of diamond grinding paste, abrasive, grinding oil for fine polishing / mirror polishing
- Suitable for all types of complex metal surface polishing
- 10pcs per pack



Order Code TMGW40	Dia. (mm)	Thickness (mm)	Shank Dia.(mm)	Price RM
-13025F	30	25	6	9.10
-14025F	40	25	6	10.20
-15025F	50	25	6	11.20
-16025F	60	25	6	12.10
-18025F	80	25	6	16.60

Surface Conditioning Flap Discs for Stainless Steel

- Suitable for processing stainless steel, steel, aluminum, non-ferrous metals and before painting process. Quick and efficient grinding and polishing, does not change the shape and size of the workpiece
- Durable & long life
- 5pcs per pack



Order Code TMDC10	Dia. (mm)	Bore Dia. (mm)	Grit	Max Speed (rpm)	Price RM
-41010B	115	22	Coarse	13,300	35.90
-42011B	115	22	Medium	13,300	35.90
-43012B	115	22	Fine	13,300	35.90
-51020B	125	22	Coarse	12,200	39.50
-52021B	125	22	Medium	12,200	39.50
-53022B	125	22	Fine	12,200	39.50

30pc Diamond Coated Burr Set - 3mm Shank

- Widely used in machining, electrical and electronic, arts and crafts and daily necessities and other industries
- Can be used for the processing of crankshaft, main bearing, connecting rod bearing, piston rod, piston ring groove, valve head and stem, gear, rack, thread and other parts. Also the plastic mould repair and so on



Order Code TMCC01	Shank Dia. (mm)	Length (mm)	Price RM
-03030A	3	45	65.00

Vitrified CBN Mounted Points for Stainless Steel

- High-quality selection of aluminium oxide abrasive series, professional pressed sintering with ceramic bonding agent into various shapes
- Resistance to water, oil, acid and alkali
- Installed in the pneumatic, power tools, use through the high-speed rotation of the metal for workpiece grinding, trimming, etc.
- Especially suitable for processing stainless steel
- 10pcs per pack



A Series (6mm Shank)





















Shape	Order Code TMGW26	Diameter (mm)	Length (mm)	Shank Dia. (mm)	Price/10 RM	
	A1	-10001A	20	63	6	237.20
	A2	-10002A	25	32	6	174.10
	A3	-10003A	25	70	6	237.20
	A4	-10004A	32	32	6	205.80
	A5	-10005A	20	28	6	174.10
	A6	-10006A	19	28	6	174.10
	A11	-10011A	21	50	6	205.80
	A12	-10012A	18	32	6	174.10
	A13	-10013A	28	28	6	174.10
	A14	-10014A	18	22	6	174.10
	A15	-10015A	6	28	6	174.10
	A21	-10021A	25	25	6	197.70
	A22	-10022A	19	16	6	174.10
	A23	-10023A	19	25	6	174.10
	A24	-10024A	6	22	6	174.10
	A25	-10025A	25	25	6	174.10
	A26	-10026A	16	16	6	174.10
	A31	-10031A	35	25	6	197.70
	A32	-10032A	25	16	6	174.10
	A33	-10033A	25	13	6	174.10
	A34	-10034A	38	9	6	174.10
	A35	-10035A	25	10	6	174.10
	A36	-10036A	40	10	6	197.70
	A37	-10037A	32	6	6	174.10
	A38	-10038A	25	25	6	197.70
	A39	-10039A	19	19	6	174.10

**Vitrified CBN Mounted Points for
Stainless Steel**

B & W Series (3mm Shank)

Shape	订货号 TMGW26	Diameter (mm)	Length (mm)	Shank Dia. (mm)	Price/10 RM
 B41	-00041B	16	16	3	122.30
 B42	-00042B	13	19	3	122.30
 B43	-00043B	6	8	3	122.30
 B44	-00044B	6	10	3	75.70
 B45	-00045B	5	8	3	122.30
 B52	-00052B	10	20	3	75.70
 B53	-00053B	8	14	3	122.30
 B54	-00054B	6	13	3	122.30
 B55	-00055B	3	6	3	122.30
 B61	-00061B	19	8	3	122.30
 B70	-00070B	19	3	3	122.30
 B71	-00071B	16	2	3	122.30
 B73	-00073B	13.5	3	3	122.30
 B81	-00081B	19	5	3	122.30
 B82	-00082B	13	6	3	122.30
 B91	-00091B	13	16	3	122.30
 B92	-00092B	6	6	3	122.30
 B96	-00096B	3	6	3	122.30
 B97	-00097B	3	10	3	122.30
 B122	-00122B	10	10	3	122.30
 B123	-00123B	5	5	3	122.30
 B131	-00131B	13	13	3	122.30
 B132	-00132B	10	13	3	122.30
 B133	-00133B	10	10	3	122.30
 B135	-00135B	6	11	3	122.30
 W144	-00144W	3	6	3	122.30
 W145	-00145W	3	10	3	122.30
 W146	-00146W	3	13	3	122.30
 W152	-00152W	5	6	3	122.30
 W153	-00153W	5	10	3	122.30
 W154	-00154W	5	13	3	122.30
 W160	-00160W	6	6	3	122.30
 W162	-00162W	6	10	3	122.30
 W163	-00163W	6	13	3	122.30
 W164	-00164W	6	19	3	122.30
 W170	-00170W	8	13	3	122.30
 W175	-00175W	10	10	3	122.30
 W176	-00176W	10	13	3	122.30

W Series (3mm Shank)

Shape	订货号 TMGW26	Diameter (mm)	Length (mm)	Shank Dia. (mm)	Price/10 RM
 W185	-10185W	13	13	6	174.10
 W186	-10186W	13	19	6	174.10
 W187	-10187W	13	25	6	174.10
 W188	-10188W	13	38	6	197.70
 W189	-10189W	13	50	6	276.70
 W196	-10196W	16	25	6	182.00
 W200	-10200W	19	3	6	182.00
 W204	-10204W	19	19	6	182.00
 W205	-10205W	19	25	6	182.00
 W208	-10208W	19	50	6	276.70
 W215	-10215W	25	3	6	182.00
 W218	-10218W	25	13	6	197.70
 W220	-10220W	25	25	6	197.70
 W221	-10221W	25	38	6	276.70
 W222	-10222W	25	50	6	300.50
 W225	-10225W	32	6	6	197.70
 W230	-10230W	32	32	6	300.50
 W235	-10235W	38	6	6	237.20
 W236	-10236W	38	13	6	261.10
 W237	-10237W	38	25	6	316.30
 W238	-10238W	38	38	6	371.80
 W242	-10242W	5	25	6	435.10

Black Plastic Handled Sharpener

- Durable construction will provide top performance and reliable service
- Round diamond surfaces to handle nearly every sharpening need for industrial use.



Order Code	Overall (mm)	Flute (mm)	Price RM
TMAB01			
-07001A	415	270	135.30

Resin Bonded Mounted Point Sets

5 Pieces Set



Order Code TMGW25	Shape	Dia. (mm)	Length (mm)	Shank Dia. (mm)	number	Price RM
-80005T	A	10	25	6	1	186.00
	A	16	32	6	1	
	A	19	32	6	1	
	B	25	10	6	1	
	B	32	10	6	1	

8 Pieces Set



Order Code TMGW25	Shape	Dia. (mm)	Length (mm)	Shank Dia. (mm)	number	Price RM
-80008T	A	10	25	6	1	199.80
	A	16	32	6	1	
	A	19	32	6	1	
	B	25	10	6	1	
	B	32	10	6	1	
	I	19	38	6	1	
	O	16	32	6	1	
	O	19	38	6	1	

10 Pieces Set



Order Code TMGW25	Shape	Dia. (mm)	Length (mm)	Shank Dia. (mm)	number	Price RM
-80010T	A	10	19	6	1	174.00
	A	10	25	6	1	
	A	13	25	6	1	
	A	19	32	6	1	
	B	25	10	6	1	
	A	25	25	6	1	
	B	32	10	6	1	
	B	32	13	6	1	
	O	16	32	6	2	

Vitrified CBN Mounted Point Sets

6 Pieces Set



Order Code TMGW26	Shape	Dia. (mm)	Length (mm)	Shank Dia. (mm)	number	Price RM
-80006T	A5	20	28	6	1	153.50
	A25	25	25	6	1	
	A26	16	16	6	1	
	A37	32	6	6	1	
	A11	21	50	6	1	
	W178	10	25	6	1	

8 Pieces Set



Order Code TMGW26	Shape	Dia. (mm)	Length (mm)	Shank Dia. (mm)	number	Price RM
-80008T	A4	32	32	6	1	193.90
	A5	20	28	6	1	
	A11	21	50	6	1	
	A25	25	25	6	1	
	A26	16	16	6	1	
	A37	32	6	6	1	
	A38	25	25	6	1	
	W178	10	25	6	1	

12 Pieces Set



Order Code TMGW26	Shape	Dia. (mm)	Length (mm)	Shank Dia. (mm)	number	Price RM
-80010T	A4	32	32	6	1	284.10
	A5	20	28	6	1	
	A11	21	50	6	1	
	A15	6	28	6	1	
	A24	6	22	6	1	
	A26	16	16	6	1	
	A37	32	6	6	1	
	A38	25	25	6	1	
	W178	10	25	6	1	
	W187	13	25	6	1	
	W201	19	6	6	1	
	W217	25	10	6	1	

Flexible Aluminum Oxide Blocks

- Made of superior quality aluminium oxide sanding blocks impregnated with abrasive.
- Remains abrasive throughout the block.
- For industrial sanding and claning components and surfaces.
- Guaranteed high performance and durability
- Does not change the shape of workpiece surface, adapts well

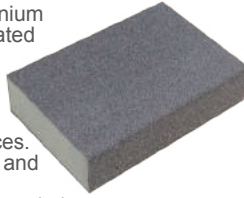

Order Code	Grit	Range (mm)	Weight / piece (g)	Price RM
TMAB01				
-00060A	P60			6.40
-00080A	P80	100 x 70	20	6.40
-00100A	P100	x 25		6.40
-00120A	P120			6.40

Order Code	Grit	Range (mm)	Weight / piece (g)	Price RM
TMAB01				
-00150A	P150	100 x 70	20	6.40
-00180A	P180	x 25		6.40
-00240A	P240			6.40

Bench Oil Stones

- A comprehensive range of bench oil stone are made of hard abrasive and sharp particles.
- Mainly used in non-ferrous metal honing, in particular, adapted to the honing machines that require smaller pressure, handwork and other deep hole boring and processing areas
- Guaranteed high performance and durability

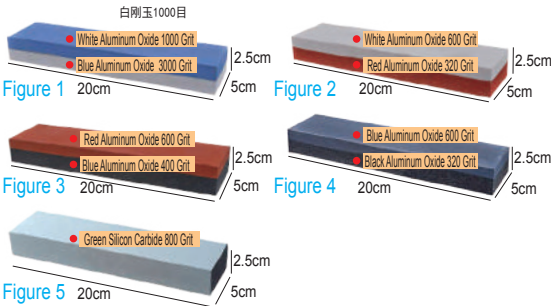

Order Code	Texture of material	Grit	Size (cm)	Figure	Price RM
TMAB01					
-01001A	Blue / White Aluminum Oxide	1000 x 3000		1	99.40
-01002A	White / Red Aluminum Oxide	600 x 320	20 x 5.0	2	62.00
-01003A	Red / Blue Aluminum Oxide	600 x 400	x 2.5	3	62.00
-01101C	Blue / Black Aluminum Oxide	600 x 320		4	62.00
-02101C	Green Silicon Carbide	800		5	62.00

Interchangeable Stainless Steel Wire Knife Brushes

- Mainly used in cleaning stubborn stains on surfaces.
- Compact and interchangeable.



Order Code	Type	Overall L. (mm)	Shank L. (mm)	Head L. (mm)	Wire width (mm)	Price RM
TMWB32						
-01001D	Straight Head	225	194	65	18	6.60
-01002D	Curved Head	245	194	65	18	6.70

Order Code	Price RM
TMWB32	
-01011P	10 83.40
-01022P	10 88.90

Twisted Knot Wire Bowl Wheels

- Ideally suited for use on bench machine, electric and pneumatics angle grinders.
- Twisted knot construction allows easy removal of rust, paint and burrs.
- Made of high quality 0.5mm steel wire



Order Code	Diameter	Hole Pattern	Weight (g)	Price RM
TMWB01				
-01025A	2.5" / 65mm	M10 x 1.5 Threaded hole	150	29.40
-01030A	3" / 75mm	M10 x 1.5 Threaded hole	250	33.00
-01130A	3" / 75mm	M14 x 2.0 Threaded hole	250	33.00
-01230A	3" / 75mm	M16 Flat hole	230	43.80
-01140A	4" / 100mm	M14 x 2.0 Threaded hole	500	42.40
-01240A	4" / 100mm	M16 Flat hole	320	56.00
-01150A	5" / 125mm	M14 x 2.0 Threaded hole	470	32.10
-01250A	5" / 125mm	M22 Flat hole	450	34.30
-01160A	6" / 150mm	M14 x 2.0 Threaded hole	730	41.60
-01260A	6" / 150mm	M22 Flat hole	700	54.70

Twisted Knot Wire Cup Wheels

- Ideally suited for use on bench machine, electric and pneumatics angle grinders.
- Twisted knot construction allows easy removal of rust, paint and burrs.
- Made of high quality 0.5mm steel wire



Order Code	Diameter	Hole Pattern	Price RM
TMWB01			
-02025A	2.5" / 65mm	M10 x 1.5 Threaded hole	43.20
-02125A	2.5" / 65mm	M14 x 2.0 Threaded hole	46.00
-02030A	3" / 75mm	M10 x 1.5 Threaded hole	62.80
-02130A	3" / 75mm	M14 x 2.0 Threaded hole	43.20
-02230A	3" / 75mm	M16 Flat hole	46.00
-02040A	4" / 100mm	M10 x 1.5 Threaded hole	62.80
-02140A	4" / 100mm	M14 x 2.0 Threaded hole	46.00
-02240A	4" / 100mm	M16 Flat hole	62.80

Bowl Type Brass-Coated Wire Derusting Wheels

- Ideally suited for use on bench machine, electric and pneumatics angle grinders.
- Crimped construction allows easy removal of rust, paint and burrs.
- Developed specially for work in larger or hard-to-reach place such as edges and corner.
- Made of high quality 0.3mm steel wire



Order Code	Diameter	Hole Pattern	Price RM
TMWB02			
-01025A	2.5" / 65mm	M10 x 1.5 Threaded hole	28.50
-01125A	2.5" / 65mm	M14 x 2.0 Threaded hole	31.50
-01030A	3" / 75mm	M10 x 1.5 Threaded hole	28.50
-01130A	3" / 75mm	M14 x 2.0 Threaded hole	31.50
-01140A	4" / 100mm	M14 x 2.0 Threaded hole	32.60
-01150A	5" / 125mm	M14 x 2.0 Threaded hole	40.60
-01160A	6" / 150mm	M14 x 2.0 Threaded hole	48.90

Twisted Knot Wire Plain Bore Brushes

- Used for cleaning, grinding welding joints, deburring, removing rust and painting, etc.
- Twisted knot Circular brush allows a higher surface speed.
- Made of high quality 0.3mm steel wire

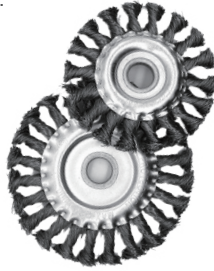

Order Code	Diameter x Bore Diameter (mm)	Price RM
TMWB10		
-01040A	100 x 16	31.50
-01045A	115 x 16	33.70
-01050A	125 x 16	34.30
-01060A	150 x 25	42.40
-01070A	175 x 32	45.10
-01080A	200 x 32	60.10
-01100A	250 x 32	108.90
-01120A	300 x 32	166.00

Twisted Knot Wire Bevelled Brushes

- Suitable for soft metals, non-ferrous metals, light metals.
- Larger surface ensure efficient cleaning, grinding welding joints, deburring, removing rust and painting, etc.
- Twisted knot Circular brush allows a higher surface speed.
- Made of high quality 0.5mm steel wire



Order Code	Diameter	Hole Pattern	Price RM
TMWB13			
-01040A	4" / 100mm	M10 x 1.5 Threaded hole	32.60
-01140A	4" / 100mm	M14 x 2.0 Threaded hole	32.60
-01145A	4.5" / 115mm	M14 x 2.0 Threaded hole	34.50
-01150A	5" / 125mm	M14 x 2.0 Threaded hole	37.30

Circular Wire Wheels

- Suitable for soft metals, non-ferrous metals, light metals.
- Larger surface ensure efficient cleaning, grinding welding joints, deburring, removing rust and painting, etc.
- Circular brush allows a higher surface speed.
- Made of high quality 0.3mm

Brass-Coated Wire

Pure Brass Wire



Brass-Coated Wire			Pure Brass Wire		
Order Code	Diameter x Bore Diameter (mm)	Price RM	Order Code	Diameter x Bore Diameter (mm)	Price RM
TMWB16			TMWB16		
-02040B	100 x 16	26.30	-03040C	100 x 16	43.80
-02050B	125 x 16	28.30	-03050C	125 x 16	46.50
-02060B	150 x 22	28.50	-03060C	150 x 22	60.10
-02080B	200 x 25	47.10	-03080C	200 x 25	73.60
-02081B	200 x 32	47.10	-03081C	200 x 32	73.60
-02100B	250 x 25	60.10	-03100C	250 x 25	136.10
-02101B	250 x 32	60.10	-03101C	250 x 32	136.10
-02120B	300 x 25	68.20	-03120C	300 x 25	184.90
-02121B	300 x 32	68.20	-03121C	300 x 32	184.90

Circular Wire Brushes - Shaft Mounted

- Suitable for soft metals, non-ferrous metals, light metals.
- Ensure efficient cleaning, grinding welding joints, deburring, removing rust and painting, etc.
- Made of high quality 0.3mm and 0.5mm Brass-Coated / Stainless steel wire

Crimped Cup Wire Brushes - Shaft Mounted

- Suitable for soft metals, non-ferrous metals, light metals.
- Ensure efficient cleaning, grinding welding joints, deburring, removing rust and painting, etc.
- Made of high quality 0.3mm Brass-Coated / Stainless steel wire

Brass-Coated Wire

Stainless Steel Wire



Dia (mm)	Height (mm)	Shank (mm)	Brass-Coated Wire		Stainless Steel Wire	
			Order Code	Price RM	Order Code	Price RM
			TMWB20		TMWB20	
38	24	6	-02040B	24.20	-04040D	24.20
50	35	6	-02050B	24.80	-04050D	24.80
60	38	6	-02060B	25.00	-04060D	25.00
75	43	6	-02075B	25.50	-04075D	25.50
100	44	6	-02100B	26.90	-04100D	26.90

Flat End Decarbonising Brushes

- Used for surface grinding and polishing of metal and non-metal, polishing and fine processing of deep holes
- Ensure efficient cleaning, grinding welding joints, deburring, removing rust and painting, etc.
- Improve the hole surface finish, angle finishing, etc.
- used for grinding and polishing internal and external surfaces.
- Made of high quality 0.3mm Brass-Coated / Stainless steel wire

Brass-Coated Wire

Stainless Steel Wire



Dia (mm)	Flute Length (mm)	Total Length (mm)	Shank (mm)	Brass-Coated Wire		Stainless Steel Wire	
				Order Code	Price RM	Order Code	Price RM
				TMWB25		TMWB25	
10	29	66	6	-02010B	4.50	-04010D	9.50
12	29	70	6	-02012B	5.00	-04012D	9.50
16	29	72	6	-02016B	5.00	-04016D	9.50
20	33	71	6	-02020B	7.20	-04020D	15.00
25	33	75	6	-02025B	7.20	-04025D	16.50
30	33	80	6	-02030B	8.00	-04030D	19.00

Brass-Coated Wire

Stainless Steel Wire



Dia (mm)	Thick (mm)	Wire Dia (mm)	Shank Length (mm)	Shank size (mm)	Brass-Coated Wire		Stainless Steel Wire	
					Order Code	Price RM	Order Code	Price RM
					TMWB29		TMWB29	
25	10	0.3	25	6	-00250B	7.80	-00250D	14.50
35	4.5	0.3	25	6	-00350B	7.80	-	-
38	7	0.3	25	6	-00400B	9.80	-00400D	16.50
50	10	0.3	25	6	-00500B	10.50	-00500D	18.50
65	10	0.3	25	6	-06500B	11.50	-06500D	19.50
75	10	0.3	25	6	-07500B	12.00	-07500D	20.00
100	10	0.3	25	6	-10000B	16.50	-10000D	25.00

TEMO®

Measuring Tools

www.temomalaysia.com



IP Ratings (Ingress Protection)

A two-digit number established by the International Electro Technical Commission, is used to provide an Ingress Protection rating to a piece of electronic equipment or to an enclosure for electronic equipment.

The protection class after EN60529 are indicated by short symbols that consist of the two code letters IP and a code numeral for the amount of the protection.

Example: IP65 (NEMA 4)

The two digits represent different forms of environmental influence:

- The first digit represents protection against ingress of solid objects.
- The second digit represents protection against ingress of liquids.

The larger the value of each digit, the greater the protection. As an example, a product rated IP54 would be better protected against environmental factors than another similar product rated as IP42.

IP..	First digit: Ingress of solid objects	Second digit: Ingress of liquids
0	No protection	No protection
1	Protected against solid objects over 50mm e.g. hands, large tools.	Protected against vertically falling drops of water or condensation.
2	Protected against solid objects over 12.5mm e.g. hands, large tools.	Protected against falling drops of water, if the case is disposed up to 15° from vertical.
3	Protected against solid objects over 2.5mm e.g. wire, small tools.	Protected against sprays of water from any direction, even if the case is disposed up to 60° from vertical.
4	Protected against solid objects over 1.0mm e.g. wires.	Protected against splash water from any direction.
5	Limited protection against dust ingress. (no harmful deposit)	Protected against low pressure water jets from any direction. Limited ingress permitted.
6	Totally protected against dust ingress.	Protected against high pressure water jets from any direction. Limited ingress permitted.
7	N/A	Protected against short periods of immersion in water.
8	N/A	Protected against long, durable periods of immersion in water.
9K	N/A	Protected against close-range high pressure, high temperature spray downs.

IP protection of the PIP:

A PIP in the standard PIP housing is generally IP51 protected. Higher IP protection level with the standard PIP housing (up to IP54) can be reached with good positioning / orientation of the PIP. In other special PIP-housings, like a MIL-housing up to IP67 protection is possible.

IP protection of the PANEL-PIP:

The PANEL-PIP is available in various housings. Those allow a protection level of up to all around IP65.

Industrial Tape Measures

- Industrial quality, durable
- Plastic composite shell, drop-proof, can effectively absorb the vibration when retract the tape
- Strong with a locking mechanism, fast retraction
- Blades are heavy gauge (30% thicker than the average tape), firm & not bending
- Nylon coating tape, wear resistant & corrosion resistant
- Hooks are heavy gauge, more reliable positioning to ensure accuracy
- Multiple international certification, to ensure the accuracy of measurement



Order Code	Size	Blade Length	Blade Width	Price RM
TMME02				
-01030A	Metric	3.0M	16mm	11.00
-01050A		5.0M	19mm	17.00
-01075A		7.5M	25mm	30.90
-02035C	Metric/ Inch	3.5M/12'	16mm	16.50
-02050C		5.0M/16'	19mm	26.50
-02080C		8.0M/26'	25mm	35.30

Outside Micrometers

- Carbide tipped anvils
- With ratchet measurement, screw-locked



Order Code	Range (mm)	Graduation (mm)	Accuracy (mm)	Price RM
TMME10				
-20025B	0-25	0.01	±0.004	166.70
-20050B	25-50	0.01	±0.004	196.70
-20075B	50-75	0.01	±0.005	215.50
-20100B	75-100	0.01	±0.005	234.20

Point Micrometers

- Suitable for measuring difficult-to-measure objects such as bit, trench and groove
- Carbide tipped anvils



Order Code	Range (mm)	Graduation (mm)	Accuracy (mm)	Price RM
TMME10				
-50025E	0-25	0.01	±0.004	378.40
-50050E	25-50	0.01	±0.004	414.00
-50075E	50-75	0.01	±0.005	462.80
-50100E	75-100	0.01	±0.005	533.90

Spherical Micrometers

- Suitable for measuring bearings, pipe fittings, bushings, pistons ring, cylinder wall thickness as well as the hole-to-edge size



Order Code	Range (mm)	Graduation (mm)	Accuracy (mm)	Price RM
TMME10				
-60025F	0-25	0.01	±0.004	343.40
-60050F	25-50	0.01	±0.004	386.60
-60075F	50-75	0.01	±0.005	444.20
-60100F	75-100	0.01	±0.005	533.10

Professional Waterproof Digital Micrometers

- Suitable for water cutting fluid spray environment
- IP54 rating [Protected against dust ingress and fluid splash]
- Zero set at any point
- Large-screen LCD display, clear and easy to read
- Metric/inch conversion at any point



IP 54

Order Code	Range	Resolution	Accuracy	Price RM
TMME10				
-10025A	0-25mm / 0- 1"	0.001mm	±0.02mm	441.90
-10050A	25-50mm / 1"- 2"	0.001mm	±0.02mm	513.30
-10075A	50-75mm / 2"- 3"	0.001mm	±0.03mm	596.20
-10100A	75-100mm / 3"- 4"	0.001mm	±0.03mm	667.50

U-Type Sheet Metal Micrometers

- Suitable for measuring thickness of steel, steel sheet, paper, plastic board and other board
- Carbide tipped anvils



Order Code	Range (mm)	Throat Depth (mm)	Graduation (mm)	Accuracy (mm)	Price RM
TMME10					
-80025H	0-25	50	0.01	±0.004	415.90
-81025H	0-25	100	0.01	±0.004	494.60
-82025H	0-25	150	0.01	±0.005	584.50
-80050H	25-50	50	0.01	±0.004	444.00
-81050H	25-50	100	0.01	±0.004	524.60
-82050H	25-50	150	0.01	±0.005	618.20

Interchangeable Anvil Micrometers

- Suitable for large diameter measurement, high precision
- Carbide tipped anvils
- Rigid and stable perforated frame that is for lightness
- Spray painted plate frame



Order Code	Range (mm)	Graduation (mm)	Accuracy (mm)	Price RM
TMME10				
-40400D	300-400	0.01	±0.011	1461.30
-40500D	400-500	0.01	±0.013	1637.40
-40600D	500-600	0.01	±0.014	1929.70
-40700D	600-700	0.01	±0.016	2308.10
-40800D	700-800	0.01	±0.018	2746.50
-40900D	800-900	0.01	±0.020	3184.90
-41000D	900-1000	0.01	±0.020	3597.10

3 Point Rod Bore Micrometers

- Carbide tipped anvils
3 claws carbide cylindrical to ensure higher wear resistance
- Can be measured near the bottom of the blind hole
- with ratchet measurement



Range (mm)	Accuracy (mm)	Mechanic Type		Digital Type		Resolution (mm)
		Order Code	Price RM	Order Code	Price RM	
6-8	±0.004	-30008A	2023.40	-30008B	2885.10	0.001
8-10	±0.004	-30010A	2023.40	-30010B	2885.10	0.001
10-12	±0.004	-30012A	2023.40	-30012B	2885.10	0.001
12-16	±0.004	-30016A	1517.50	-30016B	3091.20	0.005
16-20	±0.004	-30020A	1517.50	-30020B	3091.20	0.005
20-25	±0.004	-30025A	2117.00	-30025B	3222.40	0.005
25-30	±0.004	-30030A	2117.00	-30030B	3222.40	0.005
30-40	±0.004	-30040A	2341.80	-30040B	3615.80	0.005
40-50	±0.005	-30050A	2688.40	-30050B	1742.30	0.005
50-63	±0.005	-30063A	2847.70	-30063B	3821.90	0.005
62-75	±0.005	-30075A	3072.50	-30075B	4065.40	0.005
75-88	±0.005	-30088A	3203.60	-30088B	4215.30	0.005
87-100	±0.005	-30100A	3353.50	-30100B	4410.70	0.005

Micrometer Heads

- For machine tools, fixtures, special measuring tools, tools and other equipment that need microns precision on the parts
- High-precision measurement of the linear displacement on the XY table
- Carbide tipped anvils



Order Code	Range (mm)	Graduation (mm)	Accuracy (mm)	Price RM
TMME11				
-00065H	0-6.5	0.01	±0.004	146.10
-00130H	0-13	0.01	±0.004	146.10
-00150H	0-15	0.01	±0.004	146.10
-00250H	0-25	0.01	±0.004	127.40
-00500H	0-50	0.01	±0.005	1330.20

Mechanical Outside Micrometers

- Carbide tipped anvils and
- Spray painted plate frame



Order Code	Range (mm)	Graduation (mm)	Accuracy (mm)	Price RM
TMME10				
-30125C	100-125	0.01	±0.006	300.20
-30150C	125-150	0.01	±0.006	336.10
-30175C	150-175	0.01	±0.007	365.00
-30200C	175-200	0.01	±0.007	386.60
-30225C	200-225	0.01	±0.008	415.50
-30250C	225-250	0.01	±0.008	444.20
-30275C	250-275	0.01	±0.009	468.30
-30300C	275-300	0.01	±0.009	494.70

Single Rod Bore Micrometers

- Carbide tipped anvils



Order Code	Range (mm)	Graduation (mm)	Accuracy (mm)	Price RM
TMME12				
-10075A	50-75	0.01	±0.005	505.80
-10100A	75-100	0.01	±0.005	423.40
-10125A	100-125	0.01	±0.006	341.00
-10150A	125-150	0.01	±0.006	378.40
-10175A	150-175	0.01	±0.007	406.50
-10200A	175-200	0.01	±0.007	438.40
-10225A	200-225	0.01	±0.008	475.90
-10250A	225-250	0.01	±0.008	504.00
-10275A	250-275	0.01	±0.009	541.40
-10300A	275-300	0.01	±0.009	578.90

Caliper Type Internal Micrometers

- Suitable for a variety of internal dimensions measuring



Order Code	Range (mm)	Graduation (mm)	Accuracy (mm)	Price RM
TMME12				
-00030A	5-30	0.01	±0.005	511.50
-00050A	25-50	0.01	±0.006	681.90
-00075A	50-75	0.01	±0.007	749.40
-00100A	75-100	0.01	±0.008	824.30
-00125A	100-125	0.01	±0.009	918.00
-00150A	125-150	0.01	±0.009	1017.30
-00175A	150-175	0.01	±0.010	1114.70
-00200A	175-200	0.01	±0.010	1217.80

Stainless Steel Digital Calipers

- High-quality stainless steel ruler, alloy steel shellcover
- Corrosion-resistant, more beautiful
- With power switch
- LCD display, Legible
- Zero set at any point
- Metric/inch conversion at any point



Order Code	Range	Graduation	Accuracy	Price RM
TMME20				
-20150B	0-150mm / 6"	0.01mm	±0.02mm	346.50
-20200B	0-200mm / 8"	0.01mm	±0.03mm	471.20
-20300B	0-300mm / 10"	0.01mm	±0.04mm	692.50

Professional Waterproof Stainless Steel Digital Calipers

- Suitable for water cutting fluid spray environment
- IP67 rating [Procted against dust ingress and short periods of immersion in water]
- Corrosion-resistant more beautiful
- High-quality stainless steel ruler, alloy steel shell cover
- Zero set at any point
- Large-screen LCD display, clear and easy to read
- Metric/inch conversion at any point
- With power switch, automatically re-boot when pulling the frame



Order Code	Range	Resolution	Accuracy	Price RM
TMME20				
-10150A	0-150mm / 0-6"	0.01mm	±0.03mm	625.10
-10200A	0-200mm / 0-8"	0.01mm	±0.03mm	847.60
-10300A	0-300mm / 0-12"	0.01mm	±0.04mm	1070.50

Dial Calipers

- Shockproof & accurate
- Intuitive & legible readings



Dial Reading

Order Code	Range (mm)	Graduation (mm)	Indication / Round (mm)	Accuracy (mm)	Price RM
TMME19					
-00150D	0-150	0.02	2	±0.02	315.20
-01150D	0-150	0.01	1	±0.02	338.60
-00200D	0-200	0.02	2	±0.03	612.40
-01200D	0-200	0.01	1	±0.03	432.20
-00300D	0-300	0.02	2	±0.04	453.80

Professional Extra Long Stainless Steel Digital Calipers

- High-quality stainless steel ruler, alloy steel shellcover
- With power switch
- Corrosion-resistant, more beautiful
- Large-screen LCD display, Legible
- Zero set at any point
- Metric/inch conversion at any point

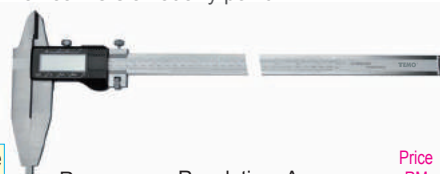

Order Code	Range	Resolution	Accuracy	Price RM
TMME20				
-10500L	0-500mm / 20"	0.01mm	±0.05mm	1733.50
-10600L	0-600mm / 24"	0.01mm	±0.05mm	2090.60
-10800L	0-800mm / 32"	0.01mm	±0.05mm	2678.20
-11000L	0-1000mm / 40"	0.01mm	±0.07mm	3419.90
-11500L	0-1500mm / 60"	0.01mm	±0.11mm	8027.50
-12000L	0-2000mm / 80"	0.01mm	±0.14mm	11623.00
-12500L	0-2500mm / 100"	0.01mm	±0.22mm	20561.60
-13000L	0-3000mm / 120"	0.01mm	±0.26mm	28481.00
-13500L	0-3500mm / 140"	0.01mm	±0.30mm	57021.10
-14000L	0-4000mm / 160"	0.01mm	±0.34mm	57033.20

Vernier Calipers

- Traditional measuring tools, durable with Inside.



Order Code	Range (mm)	Graduation (mm)	Accuracy (mm)	Price RM
TMME18				
-00100A	0-100	0.02	±0.02	252.20
-00150A	0-150	0.02	±0.02	252.20
-00200A	0-200	0.02	±0.03	345.80
-00300A	0-300	0.02	±0.04	527.70

Knife-Edge Jaw Vernier Calipers

- Both upper and lower claws are knife-shaped
- With fine-tuning, without depth measuring rod

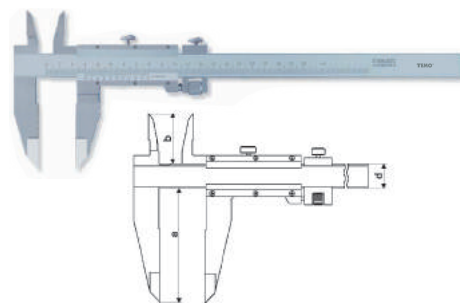

Order Code	Range (mm)	Graduation (mm)	Accuracy (mm)	a	b	d	Price RM
TMME18							
-80500K	0-500	0.02	±0.05	100	45	24	2618.70
-80600K	0-600	0.02	±0.05	100	45	24	2827.60
-81000K	0-1000	0.02	±0.07	125	60	31	8861.00

Long Jaw Internal Digital Calipers

- Upper claws easy measure small holes; arc-shaped lower claws can measure deeper hole, wear-resistant
- With reset function, zero reset at any point
 - Have data output function

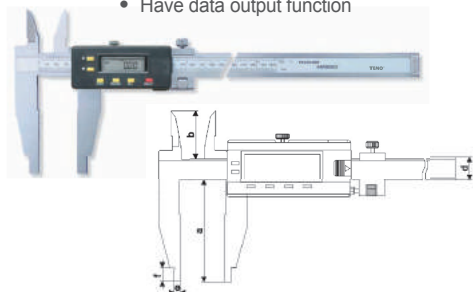

Order Code	Range (mm)	Graduation (mm)	Accuracy (mm)	Measurable hole range (mm)						Price RM
				a	b	d	e	f		
-60500A	0-500	0.01	±0.05	100	45	24	10	18	20-500	1855.10
-60600A	0-600	0.01	±0.06	100	45	24	10	18	20-600	2575.50
-60800A	0-800	0.01	±0.07	125	45	24	10	24	20-800	3926.20
-61000A	0-1000	0.01	±0.07	125	60	31	10	24	20-1000	6177.50

Long Jaw External Digital Calipers

- Both upper & lower claws can accurately perform outside measuring
- Upper claws sharp knife-shaped ; arc-shaped lower claws can measure bore diameter, wear-resistant
 - With preset function, zero reset at any point
 - Have data output function

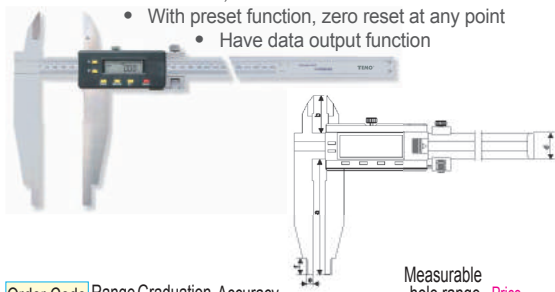

Order Code	Range (mm)	Graduation (mm)	Accuracy (mm)	Measurable hole range (mm)						Price RM
				a	b	d	e	f		
-70500A	0-500	0.01	±0.05	100	45	24	10	18	20-500	1855.10
-70600A	0-600	0.01	±0.06	100	45	24	10	18	20-600	2575.50
-70800A	0-800	0.01	±0.07	125	45	24	10	24	20-800	3926.20
-71000A	0-1000	0.01	±0.07	125	60	31	10	24	20-1000	6177.50

Long Jaw Internal Vernier Calipers

- Arc-shaped measuring surface, more suitable for internal diameter measuring and more durable than knife-shaped claws More wear-resistant
 - Long claws can measure hard to reach areas
 - With fine-tuning, without depth measuring rod

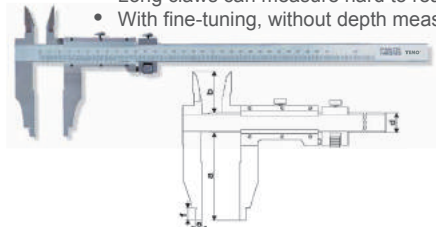

Order Code	Range (mm)	Graduation (mm)	Accuracy (mm)	Measurable hole range (mm)						Price RM
				a	b	d	e	f		
-60500A	0-500	0.02	±0.05	100	60	31	10	24	20-500	2618.70
-60600A	0-600	0.02	±0.06	100	45	24	10	18	20-600	2827.60
-61000A	0-1000	0.02	±0.07	125	60	31	10	24	20-1000	8861.00

Long Jaw External Vernier Calipers

- Both upper & lower claws can accurately perform outside measuring
- Upper claws sharp knife-shaped ; arc-shaped lower claws can measure bore diameter, wear-resistant
- Long claws can measure the hard to reach areas
 - With fine-tuning, without depth measuring rod

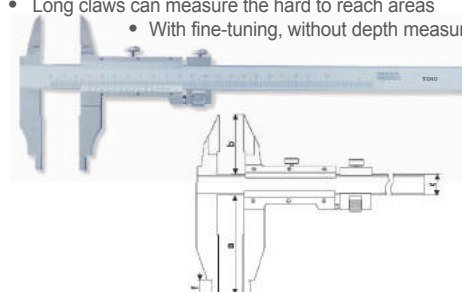

Order Code	Range (mm)	Graduation (mm)	Accuracy (mm)	Measurable hole range (mm)						Price RM
				a	b	d	e	f		
-70500A	0-500	0.02	±0.05	100	56	24	10	18	20-500	2809.50
-70600A	0-600	0.02	±0.06	100	56	24	10	18	20-600	3584.10
-70800A	0-800	0.02	±0.07	125	67	31	10	24	20-800	6249.50
-71000A	0-1000	0.02	±0.07	125	67	31	10	24	20-1000	7985.30

Long Jaw Vernier Calipers

- Arc-shaped measuring surface, more suitable for internal diameter measuring and more durable than knife-shaped claws
- With fine-tuning
- Long claws can measure the hard to reach areas

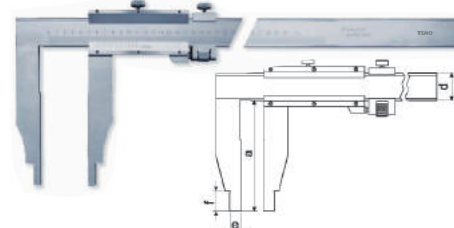

Order Code	Range (mm)	Graduation (mm)	Accuracy (mm)	Measurable hole range (mm)				Price RM
				a	b	c	d	
-50500A	0-500	0.02	±0.04	100	24	10	18	936.50
-50600A	0-600	0.02	±0.04	100	24	10	24	1044.60
-50800A	0-800	0.02	±0.05	125	31	10	24	3746.20
-51000A	0-1000	0.02	±0.05	125	31	10	24	3349.90
-51500A	0-1500	0.02	±0.08	150	31	10	24	6051.40

Long Jaw Digital Calipers

- Arc-shaped measuring claws head, more suitable for internal diameter measuring and more durable than knife-shaped claws
- With preset function, Zero reset at any point
 - With data output function

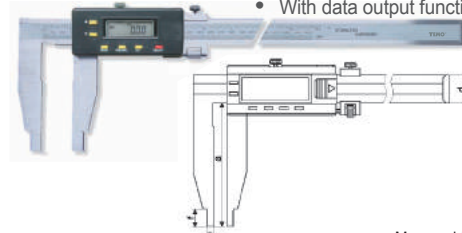

Order Code	Range (mm)	Graduation (mm)	Accuracy (mm)	Measurable hole range (mm)				Price RM
				a	b	c	d	
-50500A	0-500	0.01	±0.04	100	24	10	18	1530.80
-50600A	0-600	0.01	±0.04	100	24	10	24	2269.30
-50800A	0-800	0.01	±0.06	150	31	10	24	4430.50
-51000A	0-1000	0.01	±0.06	150	42	10	24	4555.40
-51500A	0-1500	0.01	±0.08	150	42	10	24	8644.90

Digital Blade Calipers

- Used for measuring narrow slots

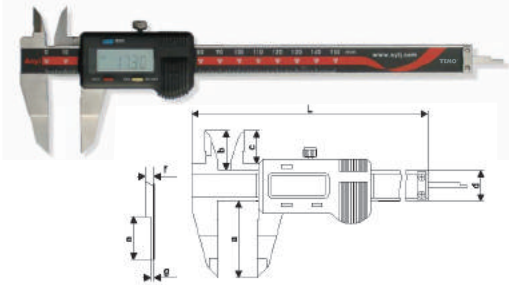

Order Code	Range (mm)	Graduation (mm)	Accuracy (mm)	L	a	b	c	d	e	f	g	Price RM
-30150A	0-150	0.01	±0.02	236	40	21	16	10	3.2	0.7		414.30
-30200A	0-200	0.01	±0.03	286	50	24	19	16	10	3.6	0.7	486.20
-30300A	0-300	0.01	±0.04	400	60	25	20	17	10	3.8	1.0	702.40

Digital Calipers with Sharp Points

- Used to measure the small size of the narrow space

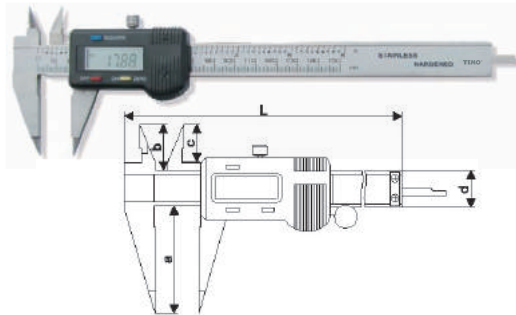

Order Code	Range (mm)	Graduation (mm)	Accuracy (mm)	L	a	b	c	d	Price RM
-20100A	0-100	0.01	±0.02	170	30	17	12	13	360.20
-20150A	0-150	0.01	±0.03	236	40	21	16	16	360.20
-20200A	0-200	0.01	±0.03	286	50	24	19	16	453.80
-20300A	0-300	0.01	±0.04	400	60	25	20	17	641.20

Vernier Depth Gauges

- Used to measure depth and steps

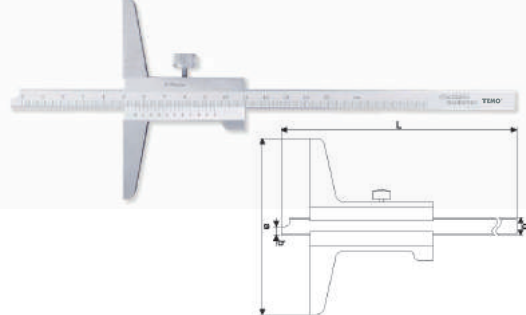

Order Code	Range (mm)	Graduation (mm)	Accuracy (mm)	L	a	b	d	Price RM
-20150D	0-150	0.02	±0.03	250	100	5	10	315.20
-20200D	0-200	0.02	±0.03	300	100	5	10	405.20
-20300D	0-300	0.02	±0.04	400	100	5	10	515.10
-20500D	0-500	0.02	±0.05	605	150	4	11	1476.80
-20600D	0-600	0.02	±0.07	768	150	6	11	2179.30
-21000D	0-1000	0.02	±0.07	1168	150	6	18	4232.40

Groove Width Digital Calipers

- Measure the inner groove width and groove location
- Zero reset at any point
- Have data output function

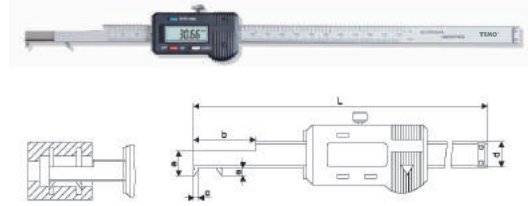

Order Code	Range (mm)	Graduation (mm)	Accuracy (mm)	L	a	b	c	d	e	Price RM
-40150G	3-150	0.01	±0.03	235	4	24	3	16	12	869.80
-40200G	3-200	0.01	±0.03	310	4	24	3	16	12	960.00
-40300G	4-300	0.01	±0.04	466	5	86	4	17	14	1231.90

Digital Depth Calipers

- For depth measurement
- With ditch head can measure groove position and groove width
- Zero reset at any point
- Metric/inch conversion at any point



Order Code	Range	Graduation	Accuracy	Price RM
-10150D	0-150mm / 0-6"	0.01mm	±0.03mm	468.40
-10200D	0-200mm / 0-8"	0.01mm	±0.03mm	631.30
-10300D	0-300mm / 0-12"	0.01mm	±0.04mm	985.10
-10500D	0-500mm / 0-20"	0.01mm	±0.04mm	1985.40

Digital Depth Gauges with Adjustable Extended Bases

- Used to measure groove position and groove width
- Adjustable widening base surface
- Zero reset at any point
- Metric/inch conversion at any point



Order Code	Range	Graduation	Accuracy	Price RM
-40300B	0-300mm / 12"	0.01mm	±0.04mm	5829.00
-40500B	0-500mm / 20"	0.01mm	±0.04mm	7954.50

Depth Micrometers

- High-precision measuring rod, large measuring range

Order Code	Range (mm)	Graduation (mm)	Accuracy (mm)	Price RM
-10025A	0-25	0.01	±0.004	318.50
-10050A	0-50	0.01	±0.004	472.10
-10100A	0-100	0.01	±0.005	472.10
-10150A	0-150	0.01	±0.005	631.40
-10200A	0-200	0.01	±0.006	949.90
-10300A	0-300	0.01	±0.007	1120.30



Dial Depth Gauges

- Stainless steel body & frame
- Closed-Type structure, more reliable positioning



Order Code	Range (mm)	Dial Reading(mm)		Accuracy (mm)	Price RM
		Graduation	Indication / Round		
-50150D	0-150	0.02	2	±0.03	405.20
-50200D	0-200	0.02	2	±0.03	546.60
-50300D	0-300	0.02	2	±0.04	853.00

Professional Digital Indicators

- Large-screen LCD display, legible easy-read
- IP54 rating [Protected against dust ingress and fluid splash]
- With power switch
- Zero reset at any point
- Metric/inch conversion at any point
- With data output function
- Axis sleeve diameter: 8mm
- Response speed: ≤ 0.5ms



IP54

Order Code	Travel	Reading	Accuracy	Price RM
-10012A	0-12.7mm / 0.5"	0.01mm	±0.02mm	422.40
-10025A	0-25.4mm / 1"	0.01mm	±0.02mm	473.80

Professional Digital Micro-Indicators

- Large-screen LCD display, legible easy-read
- IP54 rating [Protected against dust ingress and fluid splash]
- With power switch
- Zero reset at any point
- Metric/inch conversion at any point
- With data output function
- Axis sleeve diameter: 8mm
- Response speed: ≤ 0.5ms



IP54

Order Code	Travel	Reading	Accuracy	Price RM
-10012B	0-12.7mm / 0.5"	0.001mm	±0.007mm	926.40
-10025B	0-25.4mm / 1"	0.001mm	±0.009mm	1040.10

58mm 6 Jeweled Dial Indicator - Plunger Type

- Dial indicators are one of the primary measuring tools used in precision engineering.
- They are typically used to measure deck clearances, crankshaft thrust and straightness
- Dial indicator consists of a plunger and two dials, to provide a convenient starting point, dial face can be rotated on the body of the indicator to zero the pointer.
- Mounts directly on machine quill, by passing the working tool.
- Water and dust proof



Order Code	Graduation (mm)	Trip (mm)	Reading	Price RM
TMME31				
-30010A	0.01mm	10	0 - 100	272.20

32mm Ruby Stylus Dial Indicator - Lever Type

The characters of Ruby Dial Indicator:

- Hardness, resistance to wear.
- Chemical and thermal stability.
- Extremely low friction coefficient.
- Neglectable thermal expansions.
- Guaranteed accurate readings.
- Water and dust proof



Order Code	Graduation (mm)	Trip (mm)	Reading	Price RM
TMME31				
-40008A	0.01mm	0.8	0 - 40 - 0	221.00

Optical Refractometer

- A refractometer characterizes fluids based on their refractive index –the refraction occurs due to the change in the speed of light as it travels through a material of one density to one of different density.
- For research applications or those requiring very high accuracy industry such as :
 - Salinity of water
 - Sweetness of beverages
 - Hydrocarbon content of motor fuels
 - Brix, or sugar concentration in a fermentation
 - Concentration of maple syrup
 - Protein in solution
 - Machine shop coolant, etc .



Order Code	Travel	Reading	Dimensions (mm)	weight (g)	Price RM
TMME82					
-30015A	0 - 15% Brix	0.1%	30 x 40 x 160	205	323.70

Vernier Height Gauges

- Quenched stainless steel base, high flatness surface
- Carbide tipped scriber for accurate marking out
- With fine-tuning rack



Order Code	Range (mm)	Reading (mm)	Accuracy (mm)	Price RM
TMME70				
-30200C	0-200	0.02	±0.03	702.40
-30300C	0-300	0.02	±0.04	756.40
-30500C	0-500	0.02	±0.05	1530.80
-30600C	0-600	0.02	±0.07	1954.10
-31000C	0-1000	0.02	±0.07	3241.90
-31500C	0-1500	0.02	±0.10	4916.80

Twin-Beam Dial Height Gauges

- Made of durable stainless steel twin-beam
- Quenching ground base, high flatness surface
- Clear, legible and intuitive readings
- Carbide tipped scriber for accurate marking out
- With fine-tuning wheel and fastening screws



Order Code	Range (mm)	Dial Reading(mm)		Accuracy (mm)	Price RM
		Graduation	Indication / Round		
TMME70					
-20300B	0-300	0.01	1	±0.04	1700.10
-20500B	0-500	0.01	1	±0.05	2833.60
-20600B	0-600	0.01	1	±0.06	3770.10

Digital Height Gauges

- Large-screen LCD display, legible easy-read
- IP54 rating [Protet against dust ingress and fluid splash]
- With preset data function
- Relative measurement and absolute measurement conversion at any position
- Zero reset at any point
- Metric/Inch conversion at any point
- Hammered paint base
- With data output function
- Data lines need to be purchased separately



IP 54

Order Code	Travel (mm)/Inch	Reading (mm)	Accuracy (mm)	Price RM
TMME70				
-10300A	0-300 / 0-12"	0.01	±0.04	1805.80
-10500A	0-500 / 0-20"	0.01	±0.05	3141.50
-10600A	0-600 / 0-24"	0.01	±0.06	4105.30
-11000A	0-1000 / 0-40"	0.01	±0.07	22110.90

Internal Dial Calipers

- Used for measuring internal diameters and narrow grooves in hard to reach places



Order Code	Range (mm)	Graduation (mm)	Accuracy (mm)	Price RM
TMME26				
-10035A	15-35	0.01	±0.04	943.70
-10055A	35-55	0.01	±0.04	1015.80
-10075A	55-75	0.01	±0.04	1039.20
-10095A	75-95	0.01	±0.04	1089.60
-10115A	95-115	0.01	±0.04	1417.40
-10135A	115-135	0.01	±0.04	1491.30
-10155A	135-155	0.01	±0.04	1909.10

External Dial Calipers

- Used for measuring external diameters and narrow grooves in hard to reach places



Order Code	Range (mm)	Graduation (mm)	Accuracy (mm)	Price RM
TMME26				
-20020B	0-20	0.01	±0.04	943.70
-20040B	20-40	0.01	±0.04	981.60
-20060B	40-60	0.01	±0.04	1039.20
-20080B	60-80	0.01	±0.04	1089.60
-20100B	80-100	0.01	±0.04	1131.00
-20120B	100-120	0.01	±0.04	1602.90

Dial Depth Gauges

- Suitable for measuring the thickness of jewelry, leather, metal sheets, paper, film, metal wire and other materials
- When not in use, the probes can automatically close



Order Code	Range (mm)	Graduation (mm)	Accuracy (mm)	Reach / Depth	Price RM
TMME73					
-10010A	0-10	0.01	±0.02	Pocket type	351.20
-11010A	0-10	0.01	±0.02	30mm	432.20
-12010A	0-10	0.01	±0.03	120mm	576.40

Large Diameter Digital Gauges

- Suitable for measuring large-size & hi-precision shaft diameter
- Effectively avoided measurement errors on the traditional long-caliper
- It can also be used to measure the cylindricity of a large diameter shafts
- Small thickness, easy to use, one person can complete the operation independently
- Equipped with high-precision electronic components

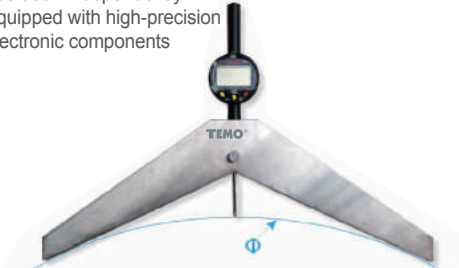

Order Code	Range (mm)	Resolution (mm)	Accuracy (mm)	Price RM
TMME23				
-20300D	∅100-300	0.001	±0.08	4952.80
-20500D	∅300-500	0.001	±0.09	5853.30
-21000D	∅500-1000	0.001	±0.10	7204.00

Digital Caliper for Outside Radius Measurement

- For non-full-circle radius measurement



Order Code	Range (mm)	Resolution (mm)	Accuracy (mm)	Price RM
TMME23				
-00150R	3-150	0.01	±0.06	1680.40

Portable Digital Angle Finder

- Easy to measure all angles and has a line drawing function
- Relative measurement and absolute measurement conversion
- Digital inversion function
- Easy operate for correction, zero reset
- With quadrant display function
- High-precision vials detect vertical and horizontal position
- The mobile ruler can be locked at any angle



Order Code	Length	Measuring range	Resolution	Accuracy	Price RM
TMME25					
-30001R	268mm	360°	0.05°/3'	0.2°	668.20

Dial Depth Gauges

- Made of precision casting
- 4 sets of combinations including the square head, center head, protractor head & ruler
- 4R, 16R, Metric/inch 3 types of scale standards to choose from
- Measuring range up to 180°
- Graduated reading to 1°
- Build-in spirit level, adjustable nut and scriber



Order Code	Length	Scale	Price RM
TMME25			
-31204R	12" / 300mm	4R = 1/64, 1/32, 1/16, 1/8	536.30
-31216R	12" / 300mm	16R = Scale 1/100, 1/50, 1/64, 1/32	517.60
-31201A	12" / 300mm	Metric, Inch = 1/64, 1/32, 0.5mm, 1mm	509.80

Universal Bevel Protractor

- For accurate measurement of internal and external angle of machines, moulds and jigs
- Measuring range: 0-360°

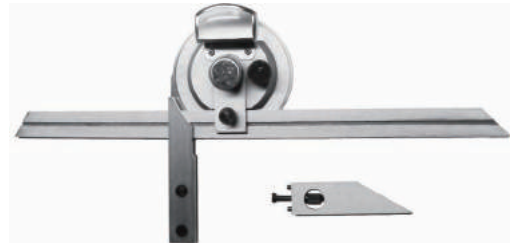

Order Code	Length	Measuring range	Resolution	Accuracy	Price RM
TMME25					
-10001M	300mm	360°	5'	±5'	457.70

Universal Bevel Protractor

- With numerical presetting function
- Moveable ruler
- Convertible direction
- 1x360° and 2x180° and 4x90° (four quadrants) three modes of measurement



Order Code	Length	Measuring range	Resolution	Accuracy	Price RM
TMME25					
-20001D	300mm	360°	30"	±5'	2302.20

180° Adjustable Stainless Steel Protractor

- Stainless steel, simple structure, easy to use
- Measuring range 180°
- Comply to the German standard DIN875



Order Code	Diameter x Straight Length (mm)	Price RM
TMME25		
-30002A	100 x 150	152.40

Digital Protractors

- Widely used in angle measurement for automotive, construction, drilling machinery and other industries
- Multi-purpose measuring tools, protractor, inclinometer and level 3-in-1
- 360° split into 4 x 90° quadrants, complete measurement
- When the inclinometer is inverted, the angle reading of the LCD will automatically flip up, easy to read
- Recalibration, does not require any special tools and equipment
- 3V lithium battery (CR2032)



Stainless Steel Measurement Faces

Order Code	Range	Resolution	Accuracy	Bottom Features	Price RM
TMME25					
-50001A	4x90° (0-360°)	0.1°	0.2°	Plane	489.10
-50002A	4x90° (0-360°)	0.1°	0.2°	2 X M4 Threaded hole	529.20
-50003A	4x90° (0-360°)	0.1°	0.2°	Magnetic	569.20
-50004A	4x90° (0-360°)	0.1°	0.2°	V-shaped	737.60

Aluminum Alloy Measurement Faces

Order Code	Range	Resolution	Accuracy	Bottom Features	Price RM
TMME25					
-50001B	4x90° (0-360°)	0.1°	0.2°	Wide Plane	489.10
-50002B	4x90° (0-360°)	0.1°	0.2°	Magnetic	577.30

Digital Protractors

- Small size, light weight, easy to carry and use
- Large-screen LCD display, easy to read
- The bottom contains the magnet, can be adsorbed on the measured workpiece



Order Code	Range	Resolution	Accuracy	Casing Features	Dimensions (mm)	Price RM
TMME25						
-60001A	0±180°	0.1°	0.2°	Plastic	50.8 x 33 x 50.8	449.00
-60002A	0±180°	0.1°	0.2°	Plastic with Vials	50.8 x 33 x 62.5	481.00
-60001B	0±180°	0.1°	0.2°	Metal	50.8 x 33 x 50.8	449.00
-60002B	0±180°	0.1°	0.2°	Metal with Vials	50.8 x 33 x 62.5	481.00

Double Ended Screw Plug Gauges - Go & No Go

- Screw plug gauges used to check internal thread.
- GO gauge passes in the machined area, whilst the NO GO gauge does not.



UNC Gauges

- Tolerance Class : 2B

Order Code	Range	Price RM
TMME30		
-03030A	1/4" - 20	174.80
-03033A	5/16" - 18	174.80
-03036A	3/8" - 16	174.80
-03039A	7/16" - 14	186.90
-03042A	1/2" - 13	186.90
-03045A	9/16" - 12	203.90
-03048A	5/8" - 11	245.10
-03051A	3/4" - 10	252.40
-03054A	7/8" - 9	276.60
-03057A	1" - 8	300.90

Metric Gauges

- Tolerance Class : 6H

Order Code	Range	Price RM
TMME30		
-01020A	M2.0 x 0.40	102.10
-01030A	M3.0 x 0.50	102.10
-01040A	M4.0 x 0.70	87.50
-01050A	M5.0 x 0.80	87.50
-01060A	M6.0 x 1.00	87.50
-01070A	M7.0 x 1.00	92.40
-01080A	M8.0 x 1.25	87.50
-01090A	M9.0 x 1.25	92.40
-01100A	M10.0 x 1.50	94.80
-01120A	M12.0 x 1.75	94.80
-01140A	M14.0 x 2.00	106.90
-01160A	M16.0 x 2.00	114.20
-01180A	M18.0 x 2.50	123.90
-01200A	M20.0 x 2.50	131.10
-01220A	M22.0 x 2.50	138.40
-01240A	M24.0 x 3.00	148.10
-01270A	M27.0 x 3.00	155.40
-01300A	M30.0 x 3.50	179.60
-01360A	M36.0 x 4.00	494.80
-01420A	M42.0 x 4.50	737.30

UNF Gauges

- Tolerance Class : 2B

Order Code	Range	Price RM
TMME30		
-04030A	1/4" - 28	189.30
-04033A	5/16" - 24	189.30
-04036A	3/8" - 24	189.30
-04039A	7/16" - 20	203.90
-04042A	1/2" - 20	203.90
-04045A	9/16" - 18	220.90
-04048A	5/8" - 18	259.60
-04051A	3/4" - 16	276.60
-04054A	7/8" - 14	300.90

Screw Ring Gauges

- Screw ring gauges used to check external thread.
- GO gauge passes in the machined area, whilst the NO GO gauge does not.
- Can be used directly, no need setting plug gauges to test them in advance.



Metric Ring Gauges

- Tolerance Class : 6g

Range	GO		NO GO	
	Order Code	Price RM	Order Code	Price RM
M2.0 x 0.40	-20020A	271.80	-21020A	271.80
M3.0 x 0.50	-20030A	228.10	-21030A	228.10
M4.0 x 0.70	-20040A	220.90	-21040A	220.90
M5.0 x 0.80	-20050A	220.90	-21050A	220.90
M6.0 x 1.00	-20060A	220.90	-21060A	220.90
M7.0 x 1.00	-20070A	240.20	-21070A	240.20
M8.0 x 1.25	-20080A	220.90	-21080A	220.90
M10.0 x 1.50	-20100A	228.10	-21100A	228.10
M12.0 x 1.75	-20120A	216.00	-21120A	216.00
M14.0 x 2.00	-20140A	240.20	-21140A	240.20
M16.0 x 2.00	-20160A	240.20	-21160A	240.20
M18.0 x 2.50	-20180A	276.60	-21180A	276.60
M20.0 x 2.50	-20200A	293.60	-21200A	293.60
M22.0 x 2.50	-20220A	293.60	-21220A	293.60
M24.0 x 3.00	-20240A	385.70	-21240A	385.70
M27.0 x 3.00	-20270A	385.70	-21270A	385.70
M30.0 x 3.50	-20300A	453.60	-21300A	453.60
M36.0 x 4.00	-20360A	652.40	-21360A	652.40
M42.0 x 4.50	-20420A	955.50	-21420A	955.50

Range	GO		NO GO	
	Order Code	Price RM	Order Code	Price RM
1/4" - 20	-24030A	297.60	-25030A	297.60
5/16" - 18	-24033A	299.80	-25033A	299.80
3/8" - 16	-24036A	302.00	-25036A	302.00
7/16" - 14	-24039A	316.30	-25039A	316.30
1/2" - 13	-24042A	325.80	-25042A	325.80
9/16" - 12	-24045A	344.90	-25045A	344.90
5/8" - 11	-24048A	419.90	-25048A	419.90
3/4" - 10	-24051A	434.20	-25051A	434.20
7/8" - 9	-24054A	521.30	-25054A	521.30
1" - 8	-24057A	620.50	-25057A	620.50

Feeler Gauges

- Made of high quality bearing steel
- Used to measure the width of various types of slots & cracks
- Each feeler has two measuring surfaces, with thickness markings
Can be used in combination
- 10 Blade Metric (mm): 0.05, 0.10, 0.15, 0.20, 0.30, 0.40, 0.50, 0.60, 0.70, 0.80
- 10 Blade Inch: 0.0015", 0.002", 0.003", 0.004", 0.006", 0.008", 0.010", 0.012", 0.015", 0.025"
- 13 Blade Metric (mm): 0.05, 0.10, 0.15, 0.20, 0.25, 0.30, 0.40, 0.50, 0.60, 0.70, 0.80, 0.90, 1.00
- 18 Blade Inch: 0.0015", 0.002", 0.0025", 0.004", 0.005", 0.006", 0.007", 0.008", 0.009", 0.010", 0.011", 0.012", 0.014", 0.015", 0.019", 0.020", 0.024", 0.025"
- 20 Blade Metric (mm): 0.05, 0.10, 0.15, 0.20, 0.25, 0.30, 0.35, 0.40, 0.45, 0.50, 0.55, 0.60, 0.65, 0.70, 0.75, 0.80, 0.85, 0.90, 0.95, 1.00
- 26 Blade Inch: 0.0015", 0.002", 0.0025", 0.003", 0.004", 0.005", 0.006", 0.007", 0.008", 0.009", 0.010", 0.011", 0.012", 0.013", 0.014", 0.015", 0.016", 0.017", 0.018", 0.019", 0.020", 0.021", 0.022", 0.023", 0.024", 0.025"



Order Code	Number of Blades	Length	Price RM
TMME60			
-80110M	10 Metric	100mm / 4"	14.80
-80113M	13 Metric	100mm / 4"	17.90
-80120M	20 Metric	100mm / 4"	24.00
-90110N	10 Inch	100mm / 4"	15.30
-90118N	18 Inch	100mm / 4"	22.60
-90126N	26 Inch	100mm / 4"	28.70

Radius Gauges

- Made of high quality bearing steel
- Can be used to measure the product internal & external diameter, concave & convex surface etc
- Each product is clearly marked with sizes for easy identification
- 34 Blade: R1.0, R1.25, R1.5, R1.75, R2.0, R2.25, R2.5, R2.75, R3.0, R3.5, R4.0, R4.5, R5.0, R5.5, R6.0, R6.5, R7.0
- 32 Blade: R7.5, R8.0, R8.5, R9.0, R9.5, R10.0, R10.5, R11.0, R11.5, R12.0, R12.5, R13.0, R13.5, R14.0, R14.5, R15.0
- 30 Blade: R15.5, R16.0, R16.5, R17.0, R17.5, R18.0, R18.5, R19.0, R19.5, R20.0, R20.5, R21.0, R21.5, R22.0, R22.5, R23.0, R23.5, R24.0, R24.5, R25.0



Order Code	Number of Blades	Price RM
TMME61		
-10034R	34	53.90
-10032R	32	56.50
-10030R	30	59.30

Long Feeler Gauges

- Made of high quality bearing steel
- Used to measure the width of various types of slots & cracks
- Each feeler has two measuring surfaces, with thickness markings
Can be used in combination
- 10 Blade Metric (mm): 0.05, 0.10, 0.15, 0.20, 0.30, 0.40, 0.50, 0.60, 0.70, 0.80
- 10 Blade Inch: 0.0015", 0.002", 0.003", 0.004", 0.006", 0.008", 0.010", 0.012", 0.015", 0.025"
- 13 Blade Metric (mm): 0.05, 0.10, 0.15, 0.20, 0.25, 0.30, 0.40, 0.50, 0.60, 0.70, 0.80, 0.90, 1.00
- 18 Blade Inch: 0.0015", 0.002", 0.0025", 0.004", 0.005", 0.006", 0.007", 0.008", 0.009", 0.010", 0.011", 0.012", 0.014", 0.015", 0.019", 0.020", 0.024", 0.025"
- 20 Blade Metric (mm): 0.05, 0.10, 0.15, 0.20, 0.25, 0.30, 0.35, 0.40, 0.45, 0.50, 0.55, 0.60, 0.65, 0.70, 0.75, 0.80, 0.85, 0.90, 0.95, 1.00
- 26 Blade Inch: 0.0015", 0.002", 0.0025", 0.003", 0.004", 0.005", 0.006", 0.007", 0.008", 0.009", 0.010", 0.011", 0.012", 0.013", 0.014", 0.015", 0.016", 0.017", 0.018", 0.019", 0.020", 0.021", 0.022", 0.023", 0.024", 0.025"

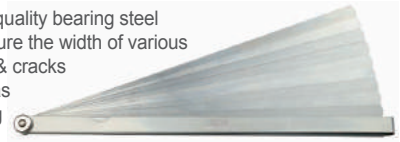

Order Code	Number of Blades	Length	Price RM
TMME60			
-80210M	10 Metric	300mm / 12"	50.00
-80213M	13 Metric	300mm / 12"	65.40
-80220M	20 Metric	300mm / 12"	92.00
-90210N	10 Inch	300mm / 12"	55.70
-90218N	18 Inch	300mm / 12"	88.50
-90226N	26 Inch	300mm / 12"	116.20

Screw Pitch Gauges

- Made of high quality bearing steel material
- With clearly marked with sizes for easy identification
- 30 Blade, Metric 60° : 0.25, 0.30, 0.35, 0.40, 0.45, 0.50, 0.55, 0.60, 0.65, 0.70, 0.75, 0.80, 0.85, 0.90, 1.00, 1.10, 1.20, 1.25, 1.30, 1.40, 1.50, 1.60, 1.70, 1.75, 1.80, 1.90, 2.00, 2.25, 2.50, 3.00
- 24 Blade ISO 60° : 0.25, 0.30, 0.35, 0.40, 0.45, 0.50, 0.60, 0.70, 0.75, 0.80, 0.90, 1.00, 1.25, 1.50, 1.75, 2.00, 2.50, 3.00, 3.50, 4.00, 4.50, 5.00, 5.50, 6.00
- 29 Blade British Standard BSW 55° : 4, 4.5, 5, 6, 7, 8, 9, 10, 11, 12, 13, 14, 16, 18, 19, 20, 22, 24, 25, 26, 28, 30, 32, 34, 36, 38, 40, 48, 60 TPI (another piece is empty)
- 6 Blade American NPT Pipe Thread 60° : 8, 10, 11, 14, 19, 28 TPI

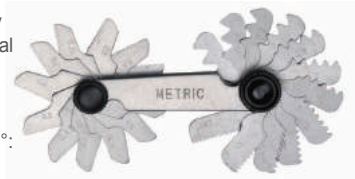

Order Code	Type	Number of Blades	Price RM
TMME62			
-80030M	Metric 60°	30	53.90
-80025M	ISO 60°	24	50.90
-90029W	British Standard BSW 55°	29	67.30
-90006N	American NPT Pipe Thread 60°	6	18.60

Sine Bars

- Sine bar is the use of trigonometry angle measurement of a precision measuring tools, generally used to measure with taper or angle of the parts
- Often used in conjunction with block gauge, measuring the angle and taper of the workpiece
- Use example:
 - Taking the 5 ° angle as an example, calculate the height of the block gauge: sin5 value is 0.0871557, multiply biaxial distance 127 mm (5") by 0.0871557 = 11.06878 mm, So you should select the 10mm + 1.07 or 10mm + 1.06 block rules gauge in combination
 - Taking the 12 ° angle as an example, calculate the height of the block gauge: sin12 value is 0.20791, multiply biaxial distance 127 mm (5") by 0.20791 = 26.405 mm, So you should choose 25mm + 1.4 block gauge used in combination

Precision Type

- Heat treatment, fine grinding
- Parallelism 0.001mm (0.00004 ")
- Two-axis distance accuracy of 0.005mm (0.0002 ")
- With the back plate
- Upper surface accuracy 0.0007mm (0.00003 ")

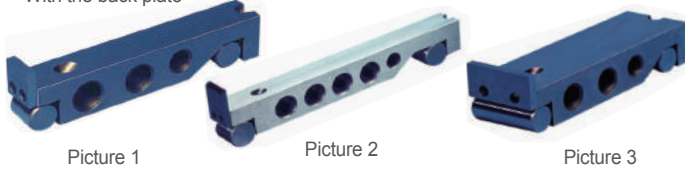

Order Code	Width	Biaxial Distance	Picture	Price RM
-41032A	23.8mm(15/16")	127mm(5")	1	1007.70
-41039A	25.4mm(1")	254mm(10")	2	2058.30
-41046A	50.8mm(2")	127 mm(5")	3	1409.00

Economic Type

- Heat treatment, fine grinding
- Parallelism 0.01mm (0.0004 ")
- Two-axis distance accuracy of 0.01mm (0.0004 ")
- With the back plate



Order Code	Width	Biaxial Distance	Price RM
-41053A	25.4mm(1")	63.5mm(2-1/2")	683.20
-41060A	25.4mm(1")	127mm(5")	694.20

Precision Granite Surface Plates

- Granite platform is made of natural stone materials, the ideal reference plane for precision measurement tools, instruments, precision tools, mechanical parts, etc.
- Due to the unique characteristics of granite, for high-precision measurement is far better than the cast iron platform
- After rigorous physical testing and selection of fine-grained, hard texture, compressive strength of 2290-3750kg / cm², Hardness: Mohs hardness of 6-7 Extremely wear-resistant against wear, acid & alkali. High corrosion resistance, never rust
- Non-metallic materials, no magnetic reaction nor plastic deformation
- Options: Bracket



Size (mm) L x W x H	Weight (kg)	00 level (Accuracy μm)	Order Code TMME01	Price RM	0 level (Accuracy μm)	Order Code TMME01	Price RM	1 level (Accuracy μm)	Order Code TMME01	Price RM
300×300×50	19	3.0	-10300B	670.30	5.5	-10300C	670.30	11.0	-10300D	670.30
400×400×100	48	3.5	-10400B	819.30	6.5	-10400C	819.30	13.0	-10400D	819.30
630×400×100	76	3.5	-10630B	1884.30	7.0	-10630C	1884.30	14.0	-10630D	1884.30
630×630×130	155	4.0	-20630B	2979.00	8.0	-20630C	2979.00	16.0	-20630D	2979.00
800×500×130	156	4.0	-10800B	3649.30	8.0	-10800C	3649.30	16.0	-10800D	3649.30
1000×630×130	284	4.5	-11000B	10612.80	9.0	-11000C	10612.80	18.0	-11000D	10612.80
1000×750×150	338	4.5	-21000B	10985.10	9.0	-21000C	10985.10	18.0	-21000D	10985.10
1000×1000×150	450	5.0	-31000B	2904.50	10.0	-31000C	2904.50	20.0	-31000D	2904.50
1600×1000×200	963	6.0	-11600B	5958.00	12.0	-11600C	5958.00	24.0	-11600D	5958.00
1600×1600×300	2312	6.5	-21600B	16751.00	13.0	-21600C	16384.60	26.0	-21600D	16384.60
2000×1000×200	1200	6.5	-12000B	6516.60	13.0	-12000C	6516.60	26.0	-12000D	6516.60

Precision Granite Parallel Pairs

- Supplied & use in pairs



Order Code TMME01	Size (mm)	Each pair of parallel rules				Price RM
		Parallelism Accuracy	Verticality Accuracy	H / W equal length difference	Level: 00, Accuracy Unit: μm	
-50160L	160 × 25 × 16	1.5	20	1.5	930.00	
-50250L	250 × 40 × 25	2	30	2	1343.40	
-50400L	400 × 63 × 40	4	40	4	2015.10	
-50630L	630 × 100 × 63	6	50	6	2712.60	

Steel Gauge Block Sets - Metric

- The block gauge is the reference for the length measurement, which is used for the adjustment and calibration of measuring instruments, gauges and mechanic parts. Can be used as a single piece, but also a few pieces can be used together
- Use the least amount possible and as thick as possible of the block gauges
- Select the secondary value first, then select the primary value
- Keep the measuring block clean
- High quality and stability of alloy steel
- Dimensional stability, wear-resistant, anti-magnetic, corrosion-resistant
- Accuracy:
Level 1: For Inspection Use
Level 2: For Workshop Use
- Manufactured to BS EN ISO 3650.

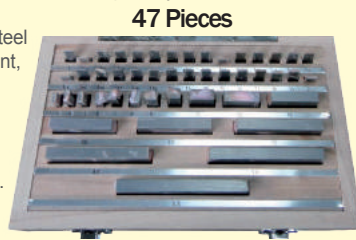

47 Pieces					
Order Code	Range				Price RM
	Range (mm)	Number of pieces	Increments (mm)	Grade	
-81147M	1.005	1	-		1644.50
	1.01 - 1.09	9	0.01		
	1.1 - 1.9	9	0.1	Grade 1	
	1 - 24	24	1		
	25 - 100	4	25		
-81247M	1.005	1	-		944.00
	1.01 - 1.09	9	0.01		
	1.1 - 1.9	9	0.1	Grade 2	
	1 - 24	24	1		
	25 - 100	4	25		

88 Pieces					
Order Code	Range				Price RM
	Range (mm)	Number of pieces	Increments (mm)	Grade	
-81188M	1.0005	1	-		2688.10
	1.001 - 1.009	9	0.001		
	1.01 - 1.49	49	0.01	Grade 1	
	0.5 - 10	20	0.5		
	20 - 100	9	10		
-81288M	1.0005	1	-		1502.10
	1.001 - 1.009	9	0.001		
	1.01 - 1.49	49	0.01	Grade 2	
	0.5 - 10	20	0.5		
	20 - 100	9	10		

Precision Square Frame Levels

- A precision measuring of pedestal surface and two precision vertical surfaces
- Suitable for detect the straightness & flatness of mechanic equipment guide rail, instrument base, flat ruler & flat board
- Made of high stability cast iron, enamel surface
- Double vials, V-shaped base



Order Code	Range (mm)	Precision (mm/m)	V-shaped groove	Price RM
-10100F	100	0.02	Not	521.70
-10150F	150	0.02	Have	561.40
-10200F	200	0.02	Have	587.10
-10250F	250	0.02	Have	764.50
-10300F	300	0.02	Have	895.20

Precision Engineers' Levels

- A rectangular level with a precision pedestal measuring surface
- Suitable for detect the straightness & flatness of mechanic equipment guide rail, instrument base, flat ruler & flat board
- Made of high stability cast iron,
- Double vials, V-shaped base



Order Code	Range (mm)	Precision (mm/m)	Colour	Price RM
-10100B	100	0.02	red	393.30
-10150B	150	0.02	black	444.70
-10200B	200	0.02	black	491.30
-10250B	250	0.02	black	540.30
-10300B	300	0.02	black	636.10

Aluminum Digital Levels

- 0°, 45°, 90° voice prompts
- Digital inversion function
- Backlight function to facilitate readings at night
- Upper and lower planes can be used as measuring surface
- Number of vials: 2
- Numerical hold function
- With slope conversion function

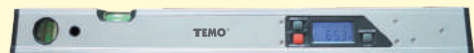

Order Code	Range (mm)	Precision (mm/m)	Price RM
-20600D	600	0.02	698.30

Aluminum Magnetic Spirit Levels

- Aluminum alloy material, coated surface, fine milled contact surface
- Soft & comfortable grip design
- Three high-precision magnification vials for vertical, horizontal & 45° measurement



Order Code	Range	Grip	Price RM
-10300A	300mm / 12"	Without grip	24.20
-10600A	600mm / 24"	Double grip	33.50
-10800A	800mm / 32"	Double grip	40.80
-11000A	1000mm / 40"	Double grip	48.10

DIN875 Tables of Tolerances for Precision Squares

Range	Maximum Angle Accuracy				Maximum Verticality Accuracy			
	00 level	0 level	1 level	2 level	00 level	0 level	1 level	2 level
mm	μm	μm	μm	μm	μm	μm	μm	μm
50	3	-	-	-	2	3	5	10
75	3	7	14	28	2	3	5	11
100	3	7	15	30	2	3	6	12
150	4	8	18	35	3	4	7	14
200	4	8	20	40	3	4	8	16
250	5	10	23	45	3	5	8	18
300	5	11	25	50	3	5	10	20
500	7	15	35	70	4	7	14	26
750	10	20	43	85	5	10	19	38
1000	12	25	60	120	6	12	24	48
1500	17	35	85	170	8	17	34	68

- High-quality stainless steel (SUS series) material, through the stability treatment and de-magnetic treatment, accurate angle
- 00 level and 0 level: suitable for inspection use
- Level 1 and Level 2: suitable for workshop / factory use
- Manufactured to German standard DIN875, DIN874

Precision Straight Edges - Laboratory

Order Code	Range	width	Price
TMME75	(mm)	(mm)	RM
-00003L	75	20	70.00
-00006L	125	20	94.70
-00007L	150	25	143.50
-00008L	175	25	126.70
-00009L	200	25	141.60
-00011L	250	30	210.70
-00013L	300	35	260.10
-00017L	400	35	410.30
-00021L	500	42	517.00
-00025L	600	42	735.00



90° Precision Square Edges - Laboratory

Order Code	Range	Price
TMME75	(mm)	RM
-10001A	50 × 40	104.50
-10003A	75 × 50	114.40
-10005A	100 × 70	134.10
-10007A	150 × 100	208.30
-10009A	200 × 130	265.00
-10011A	250 × 165	468.50
-10013A	300 × 200	531.40



90° Precision Square Edges with Bases - Laboratory

Order Code	Range	Price
TMME75	(mm)	RM
-20001B	50 × 40	181.10
-20003B	75 × 50	193.40
-20005B	100 × 70	225.60
-20007B	150 × 100	403.40
-20009B	200 × 130	541.10
-20011B	250 × 165	735.00
-20013B	300 × 200	977.20



45° Angle Rules with Bases

Order Code	Range	Price
TMME74	(mm)	RM
-40205B	100 × 70	131.70
-40206B	120 × 80	139.10
-40207B	150 × 100	156.40
-40209B	200 × 130	193.40



90° Squares - Industrial

Order Code	Range	Price
TMME74	(mm)	RM
-10101A	50 × 40	67.40
-10103A	75 × 50	72.40
-10105A	100 × 70	77.40
-10107A	150 × 100	126.70
-10109A	200 × 130	144.00
-10111A	250 × 165	196.80
-10113A	300 × 200	258.50
-10117A	400 × 250	451.20
-10121A	500 × 330	704.60



90° Squares with Bases - Industrial

Order Code	Range	Price
TMME74	(mm)	RM
-20101B	50 × 40	92.10
-20103B	75 × 50	97.10
-20105B	100 × 70	107.00
-20107B	150 × 100	144.00
-20109B	200 × 130	193.40
-20111B	250 × 165	298.90
-20113B	300 × 200	371.60
-20117B	400 × 250	492.70
-20121B	500 × 330	589.60

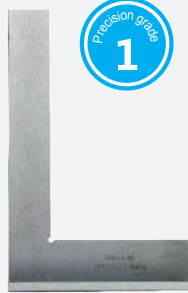

Equilateral Rules

120°		135°		Range (mm)
Order Code	Price	Order Code	Price	
TMME74	RM	TMME74	RM	
-50050A	87.90	-51050A	87.90	50 × 50
-50075A	95.70	-51075A	95.70	75 × 75
-50100A	129.40	-51100A	129.40	100 × 100
-50125A	142.30	-51125A	142.30	125 × 125
-50150A	168.20	-51150A	168.20	150 × 150
-50200A	201.80	-51200A	201.80	200 × 200



Steel Parallel Sets

- High quality alloy steel, quenching treatment, high precision, wear-resistant
- As a high-precision aids, levelling components & fixtures prior to machining processing
- Use individually or in pairs, can greatly improve the processing efficiency

10 pieces/ Inch

- Size (thickness × width × length):
1/2" × 1/8" × 6", 5/8" × 1/8" × 6", 3/4" × 1/8" × 6"
7/8" × 1/8" × 6", 1" × 1/8" × 6" 1-1/8" × 1/8" × 6"
1-1/4" × 1/8" × 6", 1-3/8" × 1/8" × 6", 1-1/2" × 1/8" × 6"
1-5/8" × 1/8" × 6"
- Accuracy:
Length: ± 0.008"
Width: ± 0.0003"
Thickness: ± 0.0002"
Parallelism 0.0003"



Price
RM
253.60

Order Code:TMME51-90010N

14 pairs/ Metric

- High quality alloy steel, quenching treatment, high precision, wear-resistant
- Size (Angle × Thickness × Length mm):
14×10×150, 16×10×150, 18×10×150, 20×10×150
22×10×150, 24×10×150, 26×10×150, 28×10×150,
30×10×150, 32×10×150, 35×10×150, 40×10×150,
45×10×150, 50×10×150
- Angle accuracy:
Length: ±0.2mm
Width: ± 0.1mm
Thickness:
± 0.005mm



Order Code:TMME51-80014M

12Pc Angle Plate Set

- High quality alloy steel, quenching treatment, high precision, wear-resistant
- Size (Angle × Thickness × Length mm):
1/4° × 6mm (1/4") × 76mm (3"), 1/2° × 6mm (1/4") × 76mm (3")
1° × 6mm (1/4") × 76mm (3"), 2° × 6mm (1/4") × 76mm (3")
3° × 6mm (1/4") × 76mm (3"), 4° × 6mm (1/4") × 76mm (3")
5° × 6mm (1/4") × 76mm (3"), 10° × 6mm (1/4") × 76mm (3")
15° × 6mm (1/4") × 76mm (3"), 20° × 6mm (1/4") × 76mm (3")
25° × 6mm (1/4") × 76mm (3"), 30° × 6mm (1/4") × 76mm (3")
- Angle accuracy: ± 20'



Price
RM
308.60

Order Code:TMME51-10012A

Optical Microscopes

- Unique structure and design, innovation, quality, function, precision upgrade series of products
- High resolution, strong three-dimensional sense, legible images
- Wide field eyepiece and adjustable focus distance & object distance devices, easy to observe, comfortable, easy to operate Zoology, botany, entomology, histology, mineralogy, archeology, Geology and medical biochemistry research and dissection tools
- High magnification lens for electronics, opticals, semiconductors and other industries inspection use
- Use for precision metal & non-metallic parts finished product observation, inspection, assembly and measurement
- For cracks of finished product, stomatal shape & corrosion surface checking and judgement
- Lens, prism or other transparent material surface quality and precision calibration test
- Documents, banknotes & jewelry value appraisal. Also other various industries analysis, research and etc
- There are computer connecting model to choose from (optional)

Binocular Stereo Microscopes

- ø90 black and white two-color coated optical system for improved light transmission and overall image quality.
- Column height 250mm, can up & down fine-tune the focal length: 45mm
- Binocular, adjustable fixed magnification
- Field of view: 20mm - 5mm
Object distance: 110mm
- Replaceable eyepiece or retrofit objective to increase or decrease the magnification



Order Code	Magnification	Price RM
TMME82		
-00121F	10X / 20X	5832.60
-00131F	10X / 30X	5832.60
-00141F	10X / 40X	5832.60

Binocular Stereo Microscope (Zoom Continuous Magnification)

- ø90 black and white two-color coated optical system for improved light transmission and overall image quality.
- Column height 250mm, can up & down fine-tune the focal length: 45mm
- Large binocular, ZOOM adjustable magnification microscope head
- Field of view: 28mm - 4mm,
object distance: 90mm
- Replaceable eyepiece or retrofit objective to increase or decrease the magnification



Order Code	Magnification	Price RM
TMME82		
-01001M	7X - 45X	12248.40

**Binocular Stereo Microscope
(Zoom Continuous Magnification)**

- Single adjustable upper and lower halogen light transmission fine-casting base
- Square column height 150mm, can up & down fine-tune the focal length: 90mm
- Large binocular, ZOOM adjust-variable magnification rate microscope head
- Field of view: 28mm - 4mm
Object distance: 90mm
- **Replaceable eyepiece or retrofit objective to increase or decrease the magnification rate**



Order Code	Magnification	Price RM
TMME82		
-02002M	7X - 45X	13644.70

**Binocular Stereo Microscope
(Zoom Continuous Magnification)**

- Dual adjustable upper and lower halogen light transmission fine-casting base
- Square column height 150mm, can up & down fine-tune the focal length: 90mm
- Large binocular, ZOOM adjust-variable magnification rate microscope head
- Field of view: 28mm - 4mm
Object distance: 90mm
- **Replaceable eyepiece or retrofit objective to increase or decrease the magnification rate**



Order Code	Magnification	Price RM
TMME82		
-03003M	7X - 45X	14121.90

Tool Microscopes

- Dual adjustable upper and lower halogen light transmission fine-casting base
- Binocular ZOOM adjust-variable magnification rate microscope head
- X-Y measuring stage (including 360 ° rotating table)
- X-Y electronic micrometer head, Resolution: 0.001mm / 0.00005 "
- 10X cross-eyepiece and CCD external device
Tool Microscopes
- **Replaceable eyepiece or retrofit objective to increase or decrease the magnification rate**



Order Code	Magnification	Measuring Range (mm)	Price RM
TMME82			
-06025M	7.5X - 34X	25*25	21757.30
-06050M	7.5X - 34X	50*50	28296.90
-06025L	7X - 45X	25*25	29693.20
-06050L	7X - 45X	50*50	36737.60

**Trinocular Stereo Microscope
(Zoom Continuous Magnification)**

- No light transmission large fine-casting base (380x250mm)
- Column height 250mm, can up & down fine-tune the focal length: 45mm
- Large binocular ZOOM adjust-variable magnification rate, CCD external device
- Field of view: 28mm - 4mm
Object distance: 90mm
- **Replaceable eyepiece or retrofit objective to increase or decrease the magnification rate**



Order Code	Magnification	Price RM
TMME82		
-08004T	7X - 45X	15624.30

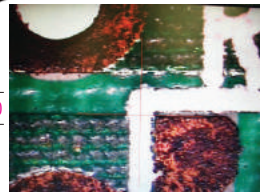

**Optional accessories:
Image device kit**

Order Code	Contains attachments	Price RM
TMME82		
-08004P	1) 1/3 "color camera 2) computer image read card 3) LED light set	8509.00

Trinocular Metallurgical Microscope

- 10X Trinocular microscope
- On the coaxial light source base
Flat achromatic revolving nose piece objective lens
- CCD interface device (CCD optional)
- X-Y cross stage,
Stage size: 185x140mm
- Dimmable halogen lighting device:
6V / 20W
- Coaxial focusing device,
adjustable to minimum 0.002mm



Order Code	Magnification	X-Y Moving Range (mm)	Objective Lens	Price RM
TMME82				
-09001M	100X / 200X / 400X	75 × 50	10X / 20X / 40X	31495.90



**Optional accessories:
Image device kit**

Order Code	Include attachments	Price RM
TMME82		
-09001P	1) 1/3 "color camera 2) Computer Image Reader Card	6766.80

Manual Rockwell Hardness Tester

Rockwell hardness scale, Indentor, Test Force and Application Range

- Hardness is one of the important indicators of mechanical properties of materials, and hardness test is the important means to determine the quality of metal materials or parts. Due to the hardness of the metal and the mechanical properties are related between each other, therefore, by measuring hardness of the metal, the machine performance such as strength, fatigue, creep and wear can be approximately calculated.
- This instrument is suitable for testing Rockwell hardness of materials. The speed of the test force is adjusted by the buffer and the test force is changed by rotating the hand wheel.
- The instrument is easy to operate, stable performance, widely used.

Scale Symbol	Indentor	Preliminary Test Force (N)	Total Test Force (N)	Typical Application
HRA	Spheroconical Diamond	98.07N (10Kg)	588.4 (60Kg)	Cemented carbides, thin steel and shallow case hardened steel
HRB	Ball 1/16" (1.588mm)		980.7 (100Kg)	Copper alloys, soft steels, alum. Alloys, malleable iron, etc.
HRC	Spheroconical Diamond		1471 (150Kg)	Steel, hard cast irons, pearlitic malleable iron, titanium, deep case hardened steel & other material harder than HRB 100

Technical parameters, rulers and applications:

- Preliminary test force: 98N
- Total test force: 588N 980N 1471N
- Indentor size:
 - Diamond Indentor: 1.588mm Steel Ball Bearing Indentor
- Rockwell hardness test range: HRA (20 ~ 88), HRB (20 ~ 100), HRC (20 ~ 70)
- Min detection unit: 0.5HR
- Max height of test piece: 170mm
- Depth of throat: 165mm
- Dimensions: 463 × 241 × 660mm
- Weight: 70kg

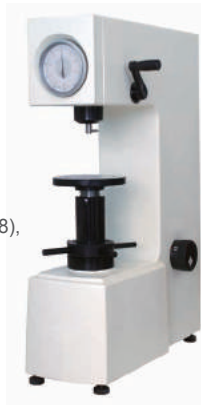

Price RM

Order Code: **TMME80-01001H** 9257.10

The standard accessories are listed in the table below

No.	Description(Size)	Quantity
1	Diamond Indentor	1
2	φ 1.588mm Steel Ball Bearing Indentor	1
3	Large Flat Anvil	1
4	Small Flat Anvil	1
5	V-Notch Anvil	1
6	Rockwell Std. Test Blocks HRC (20-30), HRC (60-70), HRB (90-100)	3
7	Weights Block A, B, C	3
8	Dust cover	1
9	Instructions Manual	1
10	Product Certificate	1

Rockwell Hardness Tester for Plastic

Plastic Rockwell hardness indication error and repeatability

- With automatic test force mechanism, loading and unloading test force complete automatically, easy & quick to operate. Except set the dial at zero, no manual operation error. High sensitivity and stability, suitable for workshops and laboratories use.
- Applications: Hard plastic, hard rubber, aluminum, tin, copper, mild steel, synthetic resin and friction materials

Scale Symbol	Standard Hardness Block Hardness Range	Hardness value indication tolerance	Indication repeatability is not greater than
HRE	70~94HRE	±2.0HRE	2.5HRE
HRL	100~120HRL	±1.2HRL	1.5HRL
HRM	85~110HRM	±1.5HRM	2.0HRM
HRR	114~125HRR	±1.2HRR	1.5HRR

Technical parameters of the hardness tester:

- Preliminary test force: 98.07N Tolerance ± 2.0%
- Total test force: 588.4N, 980.7N, 1471N tolerance ± 2.0%
- Steel ball indentor size: φ 3.175mm, φ 6.35mm & φ 12.7mm.
- Power: AC220V ± 5%, 50 ~ 60Hz
- Time limit: 2 ~ 60 seconds random key in (For plastic hardness tester, total test force retention time is 15 seconds)
- Max height of test piece: 175mm
- Depth of throat: 165mm
- Dimension (L × W × H): 520 × 215 × 700mm
- Weight: 78kg

Plastic Rockwell Hardness Test Scale, Indentor, Test Force and Application Range

Scale Symbol	Indentor	Preliminary Test Force (N)	Total Test Force (N)	Typical Application
HRE	φ 3.175mm (1/8 inch)	98.07	980.7	Hard plastic, hard rubber, aluminum, tin, copper, Mild steel, synthetic resin and friction materials.
HRL	φ 6.35mm (1/4 inch)		588.4	
HRM	φ 6.35mm (1/4 inch)		980.7	
HRR	φ 12.7mm (1/2 inch)		588.4	

Price RM

Order Code: **TMME80-01005H** 15693.10



The standard accessories are listed in the table below

No.	Description(Size)	Quantity
1	φ 3.175mm Steel Ball Indentor	1
2	φ 6.35mm Steel Ball Indentor	1
3	φ 12.7mm Steel Ball Indentor	1
4	Large Flat Anvil	1
5	Small Flat Anvil	1
6	V-Notch Anvil	1
7	Standard Rockwell Hardness Block: HRE, HRL, HRM, HRR	4
8	2A Fuses	2
9	Power Cord	1
10	Weights Block A, B, C	3
11	Spirit Level	1
12	Horizontal Adjustment Screws	4
13	Screwdriver	1
14	Spanner	1
15	Dust Cover	1
16	Instructions Manual	1
17	Product Certificate	1

Professional Flexible Mag Stands

- Clamp Hole I/D: 8mm
- Flexible Tube Length: 440mm
- Threaded base: M8 x 1.25



Order Code	Base Dimensions (mm)	Magnetic Pull (kg)	Weight (kg)	With fine adjustment	Price RM
TMME38					
-20110A	52 x 45 x 50	50	1.2	NO	418.30
-20210A	52 x 45 x 50	50	1.4	YES	499.10

Standard Mag Stands

- Clamp Hole I/D: 8mm & 6.5mm
- For dial test indicator
- Threaded base: M8 x 1.25



Order Code	Base Dimensions (mm)	Magnetic Pull (kg)	Weight (kg)	Price RM
TMME38				
-40110B	58 x 50 x 55	60	1.4	134.20
-40120B	60 x 50 x 55	80	1.4	141.90

Flexible Fine Adjusting Mag Stands

- Aluminum alloy arm
- With dovetail groove
- Clamp hole I/D: 8mm
- Threaded base: M8 x 1.25



Order Code	Base Dimensions (mm)	Magnetic Pull (kg)	Weight (kg)	Price RM
TMME38				
-10210B	58 x 50 x 55	60	1.3	206.50
-10220B	60 x 50 x 55	80	1.3	214.20

Mini Universal Magnetic Stand

- With fine adjustment
- With dovetail groove
- Clamp hole I/D: 1/4 "
- Bar length: 195mm
- Threaded base: M6 x 1



Order Code	Base Dimensions (mm)	Magnetic Pull (kg)	Weight (kg)	Price RM
TMME38				
-45110M	30 x 30 x 30	12	0.36	141.60

Professional Hydraulic Universal Mag Stands

- With fine adjustment
- With dovetail groove
- Clamp hole I/D: 8mm
- Flexible tube length: 360mm
- Threaded base: M8 x 1.25



Order Code	Base Dimensions (mm)	Magnetic Pull (kg)	Long arms (mm)	Weight (kg)	Price RM
TMME38					
-30110A	60 x 50 x 55	80	330	1.5	418.30
-30120A	60 x 50 x 55	80	380	1.5	431.00

Mini Magnetic Stand

- With fine adjustment
- With dovetail groove
- Bar length: 75mm
- Threaded base: M6 x 1



Order Code	Base Dimensions (mm)	Magnetic Pull (kg)	Weight (kg)	Price RM
TMME38				
-45120M	Φ25	10	0.2	141.60

Flexible Rustless Steel Rules

- Laser marking , anti-glare finish with permanent black figures, extremely easy to read.
- Spring tempered flexible steel blades , anti-rust
- Reverse side is marked with metric and inch table.

Metric/Inch on Each Side

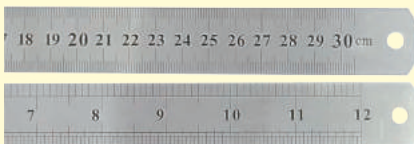

Order Code	Range (Length x Width) (mm)	Price RM
TMME02		
-30006A	150 x 19	3.90
-30012A	300 x 26	15.00
-30020A	500 x 28	28.20
-30024A	600 x 28	30.30
-30040A	1000 x 28	49.50

Metric/Inch on Same Side

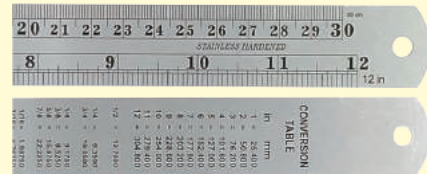

Order Code	Range (Length x Width) (mm)	Price RM
TMME02		
-30012C	300 x 26	16.80
-30020C	500 x 26	22.50

Pen Type Digital Multimeter with Light

- Compact and easy to carry; Double injection shockproof housing; band switch, easy one-handed operation; with lighting function, high visible backlight; automatic shutdown; Insulated probe with safety protection; overload protection and reverse protection
- Logic test: high level > 3.5V, low level < 1.5V
- DC voltage: 200mV / 2V / 20V / 200V / 600V
- AC voltage: 2V / 20V / 200V / 600V
- DC current: 20-200mA
- AC current: 20-200mA
- Resistance: 200Ω / 2kΩ / 20kΩ / 200kΩ / 2MΩ / 20MΩ
- Diode: 1.5V / 1mA
- Safety Standard: CAT III



Order Code	Size (mm)	Weight (g)	Price RM
TMMU10			
-11010L	230 x 57 x 30	182	203.80

Pen Type Digital Multimeter

- Compact and easy to carry; digital LCD, maximum reading 1999; auto range; data hold function; on-off function test; automatic shutdown; low voltage indication; overload protection
- DC voltage: 200mV / 2V / 20V / 200V / 600V
- AC voltage: 2V / 20V / 200V / 600V
- DC current: 20-200mA
- AC current: 20-200mA
- Resistance: 200Ω / 2kΩ / 20kΩ / 200kΩ / 2MΩ / 20MΩ
- Diode: 1.5V / 1mA
- Safety Standard: CAT II



Order Code	Size (mm)	Weight (g)	Price RM
TMMU10			
-12010V	230 x 44 x 30	110	183.60

Digital Clamp Multimeter

- Suitable for measuring AC / DC voltage, AC / DC current, resistance, frequency, and diode test
- Digital LCD, maximum reading 1999; with data hold function; current and resistance zero reset; on-off sound indicator; overload protection
- DC voltage: 1000V (± 1.0%)
- AC voltage: 750V (± 1.2%)
- DC current: 200A / 1000A (± 2.0%)
- AC current: 200A / 1000A (± 2.0%)
- Resistance: 200KΩ (± 1.0%)
- Frequency test: 2KHz (± 2.5%)
- Safety Standard: CAT II



Order Code	Size (mm)	Weight (g)	Price RM
TMMU20			
-11001A	250 x 99 x 43	400	448.10

Mini Digital Clamp Multimeter

- Mini body design, easy to carry; can withstand 2 meters drop, high reliability and ruggedness; suitable for measuring current, voltage and resistance
- Digital LCD, Maximum reading 1999; with data hold function; low voltage instructions; overload protection; on-off function test
- DC voltage: 600V (± 1.0%)
- AC voltage: 600V (± 1.2%)
- AC current: 20A / 200A / 400A (± 3.0%)
- Resistance: 2000Ω / 200KΩ (± 1.2%)
- On-off test function: Yes
- Diode test function: Yes
- Safety Standard: CAT II



Order Code	Size (mm)	Weight (g)	Price RM
TMMU20			
-12001A	151 x 65 x 34	127	114.30

Screen Foldable Digital Multimeter

- Foldable screen multi-function multimeter. Circuit design using large-scale integrated circuits, reliable performance, with automatic zero reset, polarity selection and over-range display functions, data hold functions; Ideal for laboratory, factory, & college
- 50mm foldable large-screen display
- On-off sound indicator
- Overload protection
- DC voltage: 200mV / 2V / 20V / 200V / 1000V
- AC voltage: 2V / 20V / 200V / 750V
- DC current: 20mA / 200mA / 10A
- AC current: 20mA / 200mA / 10A
- Resistance: 200Ω / 2KΩ / 20KΩ / 200KΩ / 2MΩ / 20MΩ / 200MΩ
- Capacitance test: 2nF / 20nF / 200nF / 2μF / 20μF
- Diode test: 3V / 1mA
- Transistor test: Vce=3V, Ib=10μA



Order Code	Size (mm)	Weight (g)	Price RM
TMMU11			
-12010V	200 x 97 x 48	495	197.00

Digital Multimeter / Temperature Tester

- Temperature multi-function multimeter. Circuit design using large-scale integrated circuits, reliable performance, with automatic zero reset, polarity selection and over-range display and data hold function; Ideal for laboratory, factory & college
- 70mm large screen full-function display
- On-off sound indicator
- Overload protection
- Temperature test: 0 ~ 1000 °C
- DC voltage: 200mV / 2V / 20V / 200V / 1000V
- AC voltage: 200mV / 2V / 20V / 200V / 750V
- DC current: 20μA / 200μA / 2mA / 20mA / 200mA / 1A / 10A
- AC current: 20μA / 200μA / 2mA / 20mA / 200mA / 1A / 10A
- Resistance: 200Ω / 2KΩ / 20KΩ / 200KΩ / 2MΩ / 20MΩ / 200MΩ
- Capacitance test: 2000pF / 20nF / 200nF / 2μF / 20μF
- Frequency test: 20KHz / 2MHz
- Duty cycle: 0.1% ~ 99.9%
- Level: High > 2.0V; Low < 0.8V
- Diode test: 3V / 1mA
- Transistor test: Vce=3V, Ib=10μA



Order Code	Size (mm)	Weight (g)	Price RM
TMMU30			
-11010T	200 x 97 x 48	495	254.40

Auto Range Digital Multimeter

- Auto range conversion
- With both Analog display & LCD display screens can display two different parameters at the same time
- Measure AC and DC voltage, current, resistance, capacitance, frequency, diode, transistor
- On-off sound indicator Data hold function
- Power switch
- DC voltage: 326mV ~ 1000V
- AC voltage: 3.26V ~ 750V
- DC current: 326μA ~ 10A
- AC current: 326μA ~ 10A
- Resistance: 326Ω ~ 3.62MΩ
- Capacitance test: 326nF ~ 32.6μF
- Frequency test: 32.6kHz ~ 200kHz
- Diode test: 2.8V / 1mA
- Transistor test: Vce=3V, Ib=10μA



Order Code	Size (mm)	Weight (g)	Price RM
TMMU11			
-11010V	189 x 91 x 31.5	310	269.70

Professional Auto Range Insulation Digital Tester

- Auto range of megohmmeter (megger), very easy to measure the insulation resistance.
- With its connectivity test capabilities, insulation resistance of electrical equipments (for example motor, cable, household appliances, etc.) can be measured, also convenient for checking the continuity of the line connection. Multimeter features convenient, accurate, safe, reliable
- X-Large digital LCD display, backlight function, easy to read, Maximum reading 3999
- Analog bar graph display for fast reading
- Auto range of insulation test function
- Three Insulation Test Voltage: 250V, 500V, 1000V
- Data hold, Min / Max recording capabilities functions
- Timed test function, 30 seconds to automatically stop the test
- With Timer & Lock function to allow hand-free operation and release the timing test function
- DC voltage: 400mV / 4V / 40V / 400V ± (0.8% + 2) / 600V ± (1.0% + 2)
- AC voltage: 4V / 40V / 400V ± (1.0% + 3) / 600V ± (1.2% + 3)
- DC microamperes: 400μA / 4000μA ± (1.2% + 3)
- AC microamperes: 400μA / 4000μA ± (1.5% + 5)
- DC mA: 40mA / 400mA ± (1.5% + 3)
- AC mA: 40mA / 400mA ± (2.0% + 5)
- DC 10 A: 10A ± (2.0% + 5)
- AC 10 A: 10A ± (2.5% + 5)
- Resistance: 400Ω / 4kΩ / 40kΩ / 400kΩ / 4MΩ ± (1.0% + 3) / 40MΩ ± (3.0% + 3)
- Frequency: 4kHz / 40kHz / 400kHz ± (0.8% + 3)
- Megohm: 400MΩ ± (3.0% + 5) / 400 ~ 1000MΩ ± (5.0% + 5) / > 1000MΩ ± (10.0% + 10)
- Safety Standard: CAT III



Order Code	Size (mm)	Weight (g)	Price RM
TMMU50			
-11010R	200 x 100 x 56	620	1674.00

5 In 1 Environment Auto Range Digital Tester

- 5-in-1 Auto range digital environmental tester, suitable for various industry sites, able to work in harsh and high pressure environment . Strong design, streamlined ergonomic protective cover
- With multimeter functions of temperature test, humidity test, lighting test and sound level test
- Backlight function, maximum reading 3999, with data hold function
- Optional Auto range or Manual range
- Stand-up case
- Function switch: DC / AC
- Relative value measurement: Press "REL" button to set zero
- Auto Power Off: The instrument emits 5 short beeps and 1 long beep after about 15 minutes
- DC voltage: 0.4V / 4V / 40V / 400V / 600V ± 0.7%
- AC voltage: 4V / 40V / 400V / 600V ± 0.8%
- Resistance: 400Ω / 4KΩ / 40KΩ / 400KΩ / 4MΩ ± 1.2% / 40MΩ ± 2.0%
- Capacitance: 4nF / 40nF / 400nF / 4μF / 40μF / 200μF ± 3.0%
- Frequency: 10Hz / 100Hz / 1KHz / 10KHz / 100KHz ± 2.0%
- Duty cycle: 0.1% -99.9% ± 3.0%
- Temperature: -20 °C-400 °C ± 3.0% (0.1 °C) / -20 °C-1000 °C ± 3.0% (1 °C)
- Humidity: 30% -95% RH ± 5.0%
- Luminosity: 4000Lux / 40000Lux ± 5.0%
- Sound decibel: 35-100dB ± 4dB
- On-off test function: Yes
- Diode test function: Yes
- Safety Standard: CATIII



Order Code	Size (mm)	Weight (g)	Price RM
TMMU40	162 x 83 x 47	310	410.60

3 In 1 EMF Digital Tester

- Unique EMF electromagnetic radiation test function. Suitable for variety of industrial sites, able to work at bad and high pressure environment. Strong design, streamlined ergonomic protective cover
- Stand-up case
- Electric radiation test, temperature test, multimeter function
- Automatic range
- backlight function, the maximum reading 3999, with data hold function
- Relative value measurement: Press "REL" button to zero the meter
- Auto Power Off: The instrument emits 5 short beeps and 1 long beep after about 15 minutes
- EMF: 400mG / 4000mG
- DC voltage: 0.4V / 4V / 40V / 400V / 600V ± 0.7%
- AC voltage: 4V / 40V / 400V / 600V ± 0.8%
- Resistance: 400Ω / 4KΩ / 40KΩ / 400KΩ / 4MΩ ± 1.2% / 40MΩ ± 2.0%
- Capacitance: 4nF / 40nF / 400nF / 4μF / 40μF / 200μF ± 3.0%
- Frequency: 10Hz / 100Hz / 1KHz / 10KHz / 100KHz ± 2.0%
- Temperature: -20 °C-400 °C ± 3.0% (0.1 °C) / -20 °C-1000 °C ± 3.0% (1 °C)
- Safety Standard: CAT II



Order Code	Size (mm)	Weight (g)	Price RM
TMMU60	162 x 83 x 47	310	298.30

Ultrasonic Thickness Tester

Applications:

- Widely used in manufacturing, metal processing industry, chemical industry, commodity inspection and other testing areas
- Magnetic Induction (Ferrous): Measurement of non-ferromagnetic coatings on ferromagnetic metal substrates such as steel and iron. Coatings such as lacquer, powder, plastic, rubber, synthetic materials, phosphating layers, chromium, zinc, lead, aluminum, tin, cadmium, porcelain, enamel, oxide and so on
- Eddy Current Principle (Non-Ferrous): Measurement of the enamel, rubber, paint, plastic layer on the copper, aluminum, zinc, tin substrates

Product description:

- Can store 99 sets of measurement data
- Iron-based and non-ferrous coating thickness gauge
- With Single and Continuous two kinds of measurement options
- Metric / Imperial units conversion
- With Manual/Auto shutdown and undervoltage indication functions
- Automatically remember the calibration value and automatically identify the material of the substrate under test
- Buzzer beeps during operation, the buzzer does not sound during continuous measurement
- USB data cable output, RS-232C data cable and software connect with the PC
- Split type, providing a variety of probes, high mobility

Product parameters:

- Measurement method: F Magnetic Induction / NF Eddy Current
- Measuring range: 0 ~ 1250μm / 0 ~ 50mils (standard range)
- Resolution: 0.1μm / 1μm
- Minimum surface: F: convex 1.5mm / concave 25mm
N: convex 3mm / concave 50mm
- Minimum measurement width: 6mm
- Basic critical thickness: 0.3mm ((11.81mils)
- Accuracy: ± 1 ~ 3% n or ± 2.5μm
- Low voltage indication
- Working conditions: temperature: 0 ~ 40 °C, humidity: 10 ~ 90% RH
- Power: 2 x AAA batteries
- Size: 126 x 65 x 35mm
- Weight: 81g (without battery)

Standard accessories:

- 1 x Coating Thickness Tester
- 1 x Iron base reference block
- 1 x Aluminum base reference block
- 1 x set (4) Calibration diaphragm
- 1 x Measurement sensor
- 1 x Portable box
- 1 x Operation Manual

Optional accessories:

- RS232 or USB online cable and software
- Bluetooth devices and software



Order Code	Measuring Range	Price RM
TMMU67	0-1250μm / 0-50mil	3078.90

Ultrasonic Thickness Tester

Applications:

- For non-destructive precision measurement of the thickness of a variety of pipe, pressure vessel, plates, processing parts & etc.
- Capable of measuring the thicknesses of any hard material such as aluminum, copper, brass, zinc, polyethylene, polyvinyl chloride, gray cast iron. Also other ultrasound good conductor material such as steel, stainless steel, cast steel, glass, ceramic & plastic. glass, ceramic, plastic

Product description:

- Used the latest high-performance, low-power consumption microprocessor technology
- Auto memory of material code and sound speed value, easy to operate
- Coupling status indication
- Auto / Manual Power Shut Off function
- USB, RS-232C data output cable and PC data connection

Product parameters:

- Display: 4-digit 10mm LCD screen
- Sensor: Ultrasound 5MHz Φ10
- Measurement range (Metric / Imperial): 1.0 ~ 200mm / 0.04 ~ 8 inch
- Sound velocity range: 1000 ~ 9000m / s
- Pipe measuring lower limit: Φ15 x 2.0mm; Φ20 x 3.0mm depends on the probe
- Resolution: 0.1mm
- Accuracy: 0.5% H + 0.1 (H is the thickness of the measured material)
- Low voltage indication
- Working conditions: temperature: 0 ~ 40 ° C, humidity: <85% RH
- Power: 4 x AAA batteries
- Product Size: 120 x 62 x 30mm
- Weight: 164g (without battery)



Standard accessories:

- 1 Ultrasonic Thickness Tester
- 1 x 5MHz Φ8 sensor
- 1 x Calibration block
- 1 x Coupling agent
- 1 x Carry box
- 1 x Operation Manual

Optional accessories:

- 6MHz Φ6 small diameter sensor:
Measuring range (steel): 1.0 ~ 50.0mm Allowable contact temperature -10 °C ~ 60 °C
- 5MHz Φ12 high temperature sensor:
Measuring range (steel): 1.2 ~ 225.0mm (room temperature) Allowable contact temperature -10 °C ~ 300 °C
- Surface sensor
- USB, RS232C communication cable and software
- Bluetooth devices and software



Order Code	Measuring Range	Price RM
TMMU67		
-05001D	1.0 ~ 200mm / 0.04 ~ 8 inch	2074.00

Digital Wall Detector

- Capable to detect the wall metal, wire, wood, but also to detect the live cable
- Max detecting depth: iron metal: 100mm; non-ferrous metal (copper): 80mm
copper wire (live): 50mm; wood: 20mm
- Operating temperature range: -10 °C ~ +50 °C
- Storage temperature range: -20 °C ~ +70 °C
- Auto power off after 5 minutes
- About 6 hours of use time
- Weight: 240g
- Accessories: 1 x 9V rechargeable battery



Order Code	Weight (g)	Price RM
TMMU70		
-01101A	240	353.80

Roughness Tester

Applications:

Widely used in a variety of production sites. To measure the surface roughness of a variety of machined parts based on the selected measurement conditions, calculate and clearly show all the appropriate parameters in the LCD display.

Product description:

The instrument uses computer technology, in line with GB / T 6062 and ISO, DIN, ANSI and JIS standards. When measuring the surface roughness of a part, place the sensor on the work pieces of the measured surface, the drive mechanism within the instrument glides the sensor with constant speed along the surface to be measured, the sensor through the built-in sharp stylus detect the measured surface roughness.

At this point stylus displacement due to the workpiece surface roughness caused the inductance change of the sensor, which in the phase-sensitive rectifier output the analog signal of the measured surface roughness. After amplification and level conversion the signal into the data acquisition system, the DSP chip will filter and calculate the collected data. The measurement results will then display on the LCD, at the same time connect with the PC for communication, data analysis and printing.

- Multi-parameter measurement: Ra, Rz, Rq, Rt
- High-precision inductance sensor
- RC.PC-RC.GAUSS.D-P Four filtering methods
- Built-in lithium-ion rechargeable battery and charge control circuit, high capacity
- Mechatronics design, small size, light weight, easy to operate
- Automatic shutdown function
- Can memories 7 sets of measurement data and measurement conditions, for the next view or online processing
- Metric / Imperial conversion function
- Use "USB data line output" and "RS-232 data line output" to communicate with the PC
- Optional: Bluetooth data output



Product parameters:

- Display: blue backlight, 4-digit display, 10mm LCD
- Measurement parameters: Ra, Rz, Rq, Rt
- Measuring range: Ra, Rq: 0.005 ~ 16.00µm / 0.020 ~ 629.9 µinch Rz, Rt: 0.020 to 160.0 µm / 0.078 to 6299 µinch
- Accuracy: ≤ ± 10%
- Indicator Fluctuation: not more than 6%
- Sensor:
 - Measuring principle: Inductance Type
 - Stylus tip radius: 5µm
 - Material: Diamond
 - Measuring Force: 4mN (0.4 gf)
 - Stylus tip angle: 90 °
 - Radius of Skid curvature: 48mm
 - Max drive range: 17.5mm / 0.7 inch
 - Sampling length (optional): 0.25mm, 0.8mm, 2.5mm
- Drive speed:
 - Measurement: Vt = 0.135 mm / s when sampling length = 0.25 mm
 - When sampling length = 0.8mm, Vt = 0.5mm / s
 - When sampling length = 2.5mm, Vt = 1mm / s
 - When returning: Vt = 1mm / s
- Four filter contours:
 - Filtering profile: RC, PC-RC, GAUSS
 - Not filtered contours: D-P
 - Resolution: 0.001µm (measurement <10µm)
 - 0.01µm (10µm ≤ measurement ≤ 100µm)
 - 0.1 µm (measurement ≥ 100 µm)
- Evaluation Length (Ln): 1 ~ 5L optional
- Memory function: 7 groups
- Working environment: temperature: 0 ~ 50 °C, humidity: <80% RH
- Power: rechargeable lithium battery
- Dimensions: 140 x 52 x 18mm
- Weight: 420g



Standard accessories:

- 1 x Roughness Tester
- 1 x Screwdriver
- 1 x Standard template
- 1 x Standard sensor
- 1 x Carrying case
- 1 x Operation Manual

Optional accessories:

- Deep groove sensor
- Surface sensor
- Measuring extension rod
- Measurement stand
- RS232 or USB cable and software
- Bluetooth devices and software



Order Code	Measuring Range	Price RM
TMMU66		
-01001R	Ra, Rq: 0.005 ~ 16.00µm / 0.020 ~ 629.9 µinch Rz Rt: 0.020 ~ 160.0µm / 0.078 ~ 6299 µinch	10455.30

Vibration Meter

- In line with international standards ISO2954. Used for periodic exercise measurements, to detect imbalance and deviation of the machines in motion.
- Specially designed for on-site measurement of various mechanical vibration to provide data for quality control, uptime and plan activities for equipment maintenance
- Use high-performance accelerometer to achieve accurate and replicable measurements
- With AC signal output, easy for Auscultation and record
- Use "USB data line output" and "RS-232 data line output" to communication with PC (optional)
- Bluetooth data output options (optional)
- Headphones for stethoscopes (optional)

Parameter :

Sensor:	Piezoelectric accelerometer
Measuring range	Acceleration: 0.1 ~ 200 m / s ² peak
	Speed: 0.01 ~ 200 mm / s True RMS
	Displacement: 0.001 ~ 2.0 mm peak - peak
Frequency Range	Acceleration: 10 Hz ~ 1k Hz 10 Hz ~ 10k Hz (X10 mode for bearing inspection)
	Speed: 10 Hz ~ 1k Hz
	Displacement: 10 Hz ~ 1k Hz
Accuracy	± 5% + 2 digits
Output	2.0 v AC Load Resistance 10 kΩ
Max value hold function	Yes
Battery voltage indicator	Low voltage indication function
Data Output	USB, RS-232, Bluetooth
Working environment	Temperature: 0 ~ 50 ° C Humidity: <90% RH
Power	4 x AA batteries
Size	160 x 68 x 32 mm
Weight	181 g (without battery)

Standard accessories:

1. Vibration Meter1
2. Magnetic suction block 1
3. Piezoelectric sensor 1
4. Probe (cone) 1
5. Probe (ball) 1
- 6 Carrying case 1
7. Instruction Manual 1

Optional accessories:

1. Headphone Stethoscope
2. USB or RS-232 data cable and software
3. Bluetooth communication and software



Order Code	Measuring Range	Price
TMMU66	Acceleration: 0.1 ~ 200 m / s ² peak	RM
-06320V	Speed: 0.01 ~ 200 mm / s True RMS	2230.50
	Displacement: 0.001 ~ 2.0 mm peak - peak	

Shore Hardness Tester

- Suitable for on-site measuring hardness of rubber and plastic products
- Meet the following criteria: [Rubber - determination of indentation hardness by means of pocket hardness meters] GB / T 531-1999; "Plastic Shore hardness test method" GB / T 2411-80; DIN 53505; ISO 868; ISO 7619; ASTM D 2240; JIS K7215
- Average calculation function
- Max value hold function
- Under-voltage alarm indicator
- Use "USB data line output" and "RS-232 data line output" for communicate with the PC (optional)
- Bluetooth data output (optional)

Parameter :

Display parameter	Hardness value, average value, maximum value
Measuring range	20 ~ 90H
Accuracy	<1 H
Resolution	0.1 H
Battery voltage indicates	Low voltage indication
Working environment	0 ~ 40 ° C Humidity: 10 ~ 90% RH
Power	2 x AAA batteries
Dimensions	162 x 65 x 28 mm
Weight	170 g (without battery)

Types	Suitable Measuring Materials	Hardness
A	Soft Rubber, Soft Vulcanized Rubber, Nitrile Rubber, Thermoplastic Rubber, Thermoplastic Elastomers, Waxes, Felts, Leather Goods	20 - 90A
B	Moderate Hard Rubber, Thermoplastic Rubber, Thermoplastic Elastomer, Paper Product, Fiber Material	>90A, <20D
C	Medium Hardness Rubber, Medium Hardness Plastic and Thermoplastic, Thermoplastic Elastomer	>90B, <20D
D	Hard Plastic, Hard Rubber, Hard Thermoplastic, Hard Thermoplastic Elastomer	>90A
DO	Moderate Hard Rubber, Thermoplastic Rubber, Thermoplastic Elastomer, High Density Textile Spindle	>90C, <20D
O	Soft rubber, Thermoplastic, Thermoplastic Elastomer, Very Soft Plastic Materials and thermoplastics, Medium Density Textile Spindles	<20DO
E	Hard Sponge, EVA	>90DO, <20A
OO	Very Soft Plastic, Plastic and Thermoplastic, Sponge, Foam, Low Density Textile Spindles, Human and Animal Tissues	<20D

Standard accessories:

1. Shore Hardness Tester..... 1
2. Shore stylus length test block 1
- 3 Portable box1
4. Instruction Manual 1

Optional accessories:

1. Shore hardness test rack
2. Shore rubber hardness test block (A / D type)
3. RS232 or USB cable and software
4. Bluetooth communication and software



Figure 1



Figure 2

Order Code	Types	Figure	Price
TMMU66			RM
-06510H	A	1	1988.10
-06511H	B	1	1988.10
-06512H	C	1	1988.10
-06513H	D	1	1988.10
-06514H	DO	1	1988.10
-06515H	O	1	1988.10
-06516H	E	2	1988.10
-06517H	OO	1	1988.10

Belt Tension Meter

- Mainly used in automotive belt tension measurement. Also to measure and adjust the tension of the ribbon, filament, linear, mesh and wide objects.
Suitable for automotive, textile chemical fiber, wire and cable, wire, plastic film, paper, printing, film and other industries
- Can be used to measure and adjust the motor and other machinery belt tension. With four optional different units indication.
- Use special microcomputer circuit and quartz time base to make the measurement result more precise
- During tension measurement and adjustment, the tension of the belt is displayed on the instrument in real time, with the indicator light and the different sounds giving the tension within or outside the set value, more convenient for the user to adjust the belt tension
- The instrument can automatically store upper and lower belt tension limits, measurement units and calibration results, even if the battery is turned off or removed, the data will not be lost.
- Using "USB data line output" and "RS-232 data line output" to communicate with the PC (optional)
- Bluetooth Bluetooth data output options (optional)
Note: Tension meter inspection should meet the manufacturers requirements

Parameter :

Display	4-bit 10 mm LCD and High-Low-Standard instruction given by the color LED
Measuring range	0 ~ 750 N
	0 to 120 lb (pounds)
	0 ~ 77 kg (kg)
	0 ~ 114 Seems
Belt width	up to 36 mm
Overload alarm	750 N
Maximum load	850 N
Resolution	± 1 (unit of measurement)
Accuracy	± 5% of full scale
Data Output	USB, RS-232, Bluetooth
Sound alarm	Buzzer
Power	4 x AAA batteries
Size	135 x 62 x 33 mm
Weight	335 g (without battery)

Standard accessories:

- 1 Belt Tension Meter 1
2. Measuring sensor 1
- 3 Portable box 1
4. Instruction Manual 1

Optional accessories:

1. RS232 or USB cable and software
2. Bluetooth communication and software



Order Code	Price
TMMU66 Measuring Range	RM
0 ~ 750 N	
0 ~ 120 lb	
0 ~ 77 kg	1915.80
0 ~ 114 Seems	

Moisture Meter

- Used in workshops, factories, warehouses, libraries, offices, computer room, laboratory and other environment temperature and humidity monitoring.
- For measure humidity, temperature and wet bulb temperature.
- Using microcomputer technology, anti-interference technology and many other advanced technologies, achieve fast and precise measurement.
- Digital display, no parallax.
- Wide measuring range, high resolution.
- Auto memory the maximum, minimum and the last measured values of the humidity and temperature.
- Strong structure, delicate, easy to carry. The whole machine uses durable advanced electronic components; light weight and hard ABS plastic housing, beautiful shape, easy to operate.

Parameter :

Monitor		LCD Display
Measuring Range	Humidity	10 ~ 95% RH
	Temperature	-10 to 60 °C (14 to 140 °F)
	Wet bulb temperature	-10 to 60 °C (14 to 140 °F)
Resolution	Humidity	0.1% RH
	Temperature	0.1 °C / 0.1 °F
	Wet bulb temperature	0.1 °C / 0.1 °F
Accuracy	Humidity	2.5% ± 1% RH
	Temperature	± 0.5 °C
Sensor Type	Humidity	Humidity Capacitance
	Temperature	Thermistor
Sampling Time	0.4 seconds	
Memory	Automatically memorizes the maximum, minimum and last measured values	
Time base	Quartz crystal	
Power	4 x AAA batteries	
Size	171 x 72 x 34 mm	
Weight	145 g (without battery)	

Standard accessories:

- 1 Moisture Meter 1
- 2 Portable box 1
3. Instruction Manual 1



Order Code	Price
TMMU66 Measuring Range	RM
Humidity: 10 ~95 %RH	
Temperature: -10~60 °C (14 ~ 140 °F)	616.60
Wet bulb temperature: -10 ~60 °C (14~140 °F)	

Laser Tachometer

- Used to determine the motor speed, frequency; widely used in motors, fans, paper mills, plastic, chemical fiber, washing machines, automobiles, aircraft, ships and other manufacturing industry.
- Using many advanced technologies such as microcomputer technology, laser technology and anti-interference technology. able to accurately measure the speed value without contact
- Digital display, no parallax
- Wide measuring range, high resolution
- Auto memory the maximum, minimum and the last measured values
- Strong structure, delicate, easy to carry. The whole machine uses durable advanced electronic components; light weight and hard ABS plastic housing, beautiful shape, easy to operate.

Parameter :

Measuring Range	2.5 ~ 99,999 r / min
Resolution	0.1 r / min (0.5 ~ 999.9 r / min) 1 r / min (1000 r / min or more)
Accuracy	± (0.05% n + 1 d)
Sampling Time	1.0 s (60 r / min or more)
Range Selection	Automatically switch
Memory	maximum / minimum / last value
Time Base	quartz crystal
Effective Distance	50 ~ 250 mm (typical) Maximum 600 mm depends on the LED brightness
Power consumption	about 80 mA (during measurement)
Operating Temperature	0 ~ 50 ° C
Power	4 x AA batteries
Size	145 x 74 x 32 mm
Weight	260 g (with battery)

Standard accessories:

1. Laser Tachometer 1
2. 50mm reflection band 2
3. Portable box 1
4. Instruction Manual 1



Order Code	Measuring Range	Price
TMMU66		RM
-02857T	2.5 ~ 99,999 r / min	430.40

Multi-Functional Sound Level Meter

- Measuring the sound level of environmental, mechanical, traffic, marine and other noises;
For industrial environmental protection, construction, health, teaching and research departments
- Three weighting selection: "A" / "C" / "F" and two time weighting selection: "Fast" and "Slow"
- Four kinds of measurement parameters: Lp ordinary sound level measurement, Leq equivalent continuous A Sound level measurement, Lmax maximum sound level measurement, LN statistical sound level measurement
- With DC output 10 mV / dB
- Able to store 30 sets of measurement data and measurement status
- With "alarm value setting", "output", "automatic shutdown and manual shutdown" functions
- Adopt "USB data cable output" and "RS-232 data cable output" with PC communication (optional)
- Bluetooth™ data output" (optional)

Parameter :

Complies with standard		IEC 651.2, ANSI 1.4.2
Measurement parameters		Lp - Normal sound level measurement Leq - Equivalent continuous A-level measurement Lmax - The maximum sound level measurement LN - Statistical Sound Level Measurement
Measuring Range	Lp - Normal sound level	A Weighting: 30 ~ 130 dB C Weighting: 35 ~ 130 dB Linear: 40 ~ 130 dB
	Leq - Equivalent sound level	30 ~ 130 dB (time option: 10 seconds, 1 minute, 5 minutes, 10 minutes, 15 minutes, 30 minutes, 1 hour, 8 hours, 24 hours)
	LN - Statistics Sound Level Measurement	0 ~ 100%
Resolution		0.1 dB
Accuracy		1 dB
Frequency weighting		"A" / "C" / "F" (Flat)
Time weighting		Fast / Slow
Microphone		12.5 mm condenser microphone
Memory function		30 groups
Built-in compliance signal		94 dB
Frequency range		20 ~ 12,500 Hz
Alarm setting		30 ~ 130 dB
Alarm output		LED light alarm (optional: connect external relays to control other alarm device)
Voltage indicates		Low voltage indication
Power		4 x AAA batteries
External power socket		6 V, DC, 100 mA
Size		236 x 63 x 26 mm
Weight		170 g

Standard accessories:

1. Sound Level Meter 1
2. Windshield 1
3. Portable box 1
4. Instruction Manual 1

Optional Accessories:

1. ND9 sound level meter calibrator
2. RS232 or USB cable and software
3. Bluetooth communication and software

Order Code	Size (mm)	Weight (g)	Price
TMMU66			RM
-05868S	236 x 63 x 26	170	1035.00



Multi-Functional Anemometer

- Widely used in boilers, refrigeration, HVAC, ventilation ducts, environmental monitoring, data collection in nautical surveys, as well as weather forecasting, field work and fire department data collection. Not only to measure the wind speed, but also measure the air temperature, wave height, wind level, wind flow and wind direction
- Multi-measurement unit conversion
- High sensitivity and accurate measurement, the sensor uses ultra-low friction bearings
- Wind speed measuring handle can be separated from the fuselage, easy to measure
- With maximum value hold function
- With storage function, can store 24 sets of data
- Can be set to automatically shut down function (0 ~ 9 minutes adjustable)
- USB data cable output, RS-232C data cable and software to communication with PC (optional)
- Bluetooth™ data output (Optional)

Parameter :

Display	13 mm 4-digit LCD
Units of Measurement	Speed: m / s, km / h, ft / min, section
	Flow: CMM (m³ / min), CFM (ft³ / min)
	Wind class: Beaufort style
	Wave height: meters
	Wind direction: ° is based on the north direction
	Temperature: ° C, ° F
Data hold function	Maximum data
Memory	24 groups
Sampling Rate	about 1 second
Sensor	Wind speed / flow: 3 cups
	Wind direction: Low friction direction pointer
	Temperature: Thermistor
Auto power off	Any setting between 0 ~ 9 minutes
Operating temperature	-10 ~ 60 ° C (14 ~ 140 ° F) Humidity: <80% RH
Power	4 x AAA batteries
Size	Anemometer 156 x 67 x 28 mm (6.1 x 2.6 x 1.1 inch)
	3 cups sensor: 65 x 65 x 115 mm Direction pointer: 86 x 69 x 115 mm
Weight	375 g (with battery)

	Range
Wind speed	m / s 0.4 ~ 45.0
	km / h 1.4 ~ 162.0
	ft / min 80 ~ 8860
	knots 0.8 ~ 88.0
Flow	CMM(m³ / min) 0 ~ 9999
	CFM (foot / minute) 0 ~ 9999
	Beaufort scale 0 ~ 12
	Wind direction 0 ~ 360 °
	Wave height (m) 0 ~ 14
	Temperature 14 ~ 140 °F -10 ~ 60 °C

Standard accessories:

- 1 Anemometer..... 1
2. Measuring Sensor 1
3. Carrying case (B10) ...1
4. Three cups of sensor 1
5. Direction Pointer 1

Optional Accessories:

1. RS232 or USB cable and software
 2. Bluetooth communication and software
- Note: The cable standard length of 1.5 meters, can be customized according to user requirements

Order Code	Weight (g)	Price RM
TMMU66	375	1101.10
-04836A		



Digital Lux Meter

- Luminometer is a special instrument to measure luminosity, brightness. Applicable in electric light, scientific research teaching, metallurgical construction, industrial testing, and agriculture industry research, light control and other fields
- Digital display, no reading error
- The sensor is separated from the display meter for easy use
- A variety of unit measurements: Lux and FC
- Reliable performance, durable
- Maximum data hold function
- Low battery voltage indication
- Use durable electronic components, light and strong ABS plastic housing.
- Compact structure, easy to carry

Parameter :

Display	10 mm 4-digit LCD Display
Units of Measurement	(Lux)
	(FC)
Measuring Range	0 ~ 50,000 Lux, 3 range
	0 ~ 5,000 FC
Max value hold function	
Battery voltage indication	Low voltage indication
Operating temperature	0 ~ 50 ° C (32 ~ 122° F) Humidity: <80% RH
Power	4 x AAA batteries
Size	Anemometer 132 x 64 x 30 mm
	sensor: 96 x 58 x 16 mm
Weight	280 g (with battery)

Electrical parameters:

Range	Resolution	Accuracy (23 ± 5 ° C)
0 ~ 1,999 Lux	1 Lux	± (5% n + 5 d)
2,000 ~ 19,000 Lux	10 Lux	± (5% n + 5 d)
20,000 ~ 50,000 Lux	100 Lux	± (5% n + 5 d)
0 ~ 5,000 FC	1 FC	± (5% n + 5 d)

Standard accessories:

1. Lux Meter..... 1
2. Portable box 1
3. Instructions Manual 1



Order Code	Measuring Range	Price RM
TMMU66	0 ~ 50,000 Lux, 3 range	
-09626L	0 ~ 5,000 FC	506.50

Digital Lux Meter

- Luminometer is a special instrument to measure luminosity, brightness. Applicable in electric light, scientific research teaching, metallurgical construction, industrial testing, and agriculture industry research, light control and other fields
- Digital display, no reading error
- The sensor is separated from the display meter for easy use
- Reliable performance, durable • Maximum data hold function
- Low battery voltage indication
- Use durable electronic components, light and strong ABS plastic housing. • Compact structure, easy to carry

Parameter :

Display	10 mm 4-digit LCD Display
Units of Measurement	(Lux)
Measuring Range	0 ~ 50,000 Lux, 3 range
Max value hold function	
Battery voltage indication	Low voltage indication
Operating temperature	0 ~ 50 °C (32 ~ 122° F) Humidity: <80% RH

Electrical parameters:

Range	Resolution	Accuracy (23 ± 5 °C)
0 ~ 1,999 Lux	1 Lux	± (5% n + 5 d)
2,000 ~ 19,000 Lux	10 Lux	± (5% n + 5 d)
20,000 ~ 50,000 Lux	100 Lux	± (5% n + 5 d)

Standard accessories:

1. Lux Meter..... 1
2. Portable box..... 1
3. Instructions Manual..... 1

TMMU66-09621L



TMMU66-00101L



Price RM 282.20

Price RM 282.20

Order Code	TMMU66-09621L	TMMU66-00101L
Measuring Range	0 ~ 50,000 Lux, 3range	0 ~ 50,000 Lux, 3range
Power	4 x AAA batteries	1 x 9V battery
Anemometer(mm)	132 x 64 x 30	108 x 72 x 23
sensor(mm)	96 x 58 x 16	96 x 58 x 16
Weight (g, with battery)	280	175

Digital Breath Alcohol Tester

- Digital alcohol tester with audible alert. • LCD backlight display for easy reading. • Quick response and resume, easy to operate.
- Small size with key chain, lightweight and easy to carry.

Features:

- This is Digital Breath Alcohol tester test with audible alert Sensor.
- Sensor Range: 0.00-0.19%BAC & 0.0-1.9g/l (or 0.00-0.95mg/l BRAC) Accuracy: 0.01% BAC(0.1g/l)
- Quick response and resume Auto power off
- Use 2"AAA" alkaline batteries
- You should wait until after the blow screen test, otherwise it will show 0 Packing content:
- 1 x Digital alcohol breathalyzer tester 5 x Breath inhaler Case
- CE, FC , RoSH certifications compliance

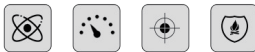

Order Code	Measuring range	Price RM
TMMU73		
-00002A	0.00 - 0.19% BAC & 0.0 - 1.9 g/l	282.20

Carbon Monoxide(CO)Detector

Applications

The gas detection instruments are widely used in petrochemical, municipal environmental protection, coal mine, fire fighting, research labs, beverage, residential places and other wide ranges of industrial environments.

Key Feature

- It uses the intellectualized design and has gotten multiple functions.
- With highlight backlight display and acousto-optic alarming, it is easily configured.
- The embedded temperature compensation enables the device to measure the correct value in the environment temperature of -10~50°C.
- As its case is ergonomically designed, it looks handsome, feels good and is easy to carry.

Specifications

- Measurement display: displays with 4 digit LCD , with backlight,Low power symbol display
- Operation temperature:-10~50°C (14~122°F)
- Storing temperature: 0~40°C(32~104°C)
- Operation humidity: 0~99%RH (relative humidity)
- Storing humidity: 20%~80% RH (relative humidity)
- Measuring range: 0~1000PPM • Resolution: 1PPM
- Measurement error: ±5%
- Over measurement range display: --OL--
- Alarming method: acousto-optic alarming
- Working principle of the sensor: electrochemistry sensor
- The service life of the sensor: 2 years (it can be then replaced)
- Power supply: 3x1.5V AAA alkaline batteries
- Battery service life: about 100 hours of continuous use (when the backlight is off).
- Size: 172x51x26 (mm)

Accessories

- 1.5V AAA battery x 3 pcs
- English Manual • Carrying case

Order Code	Measuring range	Price RM
TMMU66		
-00200A	1 - 1000PPM	782.50



Portable Gas Leak Detector

Applications

The gas leak detector can be used in the natural gas is leaked indoors and outdoors, where the gas is produced, stored, used, etc., such as chemical, petroleum, metallurgy, oil depot, LPG (Liquefied Petroleum Gas) station, gas transmission and distribution, etc. to detect the leakage and show the leaking concentration or explosion percentage with a digital display. This device can set two-level alarming value. The detector can rise the acousto-optic alarming when the detected concentration reaches the preset value. It adopts high sensitivity sensor from Japan Figaro. The meter's function is powerful. It also can synchronously measure that time's temperature and humiditywhen measuring methanegas.

Key Features

- Intellectualized design • Detectable gas: methane gas
- Acousto-optic alarming, easy to set • Display: large screen digital LCD
- Power: 4x1.5V AA battery
- Ergonomically case designed, beautiful outlook,nice operate feeling and easy to carry • Sealed pouch can improve the performance of explosion-proof

Specifications

- Principle for sensor measurement: semi-conductive method
- Detectable gas: methane gas
- Measurement range: 0~10000ppm,0~20%LEL (LEL: Lower explosive limit)
- Resolution: 1ppm,0.1%LEL • Error: ±2%
- Response time: <3s
- Measurement temperature range: -5°C~50°C, Measurement humidity range: 25%~90%RH
- Operation environment temperature: -5°C~50°C, Operation environment humidity: <90%RH
- Display: large screen digital LCD
- Alarming: acousto-optic alarming
- Power supply: 4x1.5V AA batteries
- Electric current: <90mA(Measurement status)

Accessories

- 1.5V AA battery x 4 pcs
- English manual
- Carrying case

Order Code	Measuring range	Price RM
TMMU66		
-00203A	1 - 1000PPM	1162.70



Laser Distance Meters

- FSTN LCD display
- With continuous measurement, area measurement, volumetric measurement and trigonometric functions
- Maximum/Minimum measurement function
- 100 sets of data can be saved
- With backlight on / off function
- Switchable for measuring reference point Front/Middle/End

Product Parameters

- Unit of Measurement: mm / in / ft
- Wavelength: 635nm
- Automatic shutdown time: 150s
- Storage temperature: -20 °C ~ 60 °C
- Operating temperature: 0 °C ~ 40 °C
- Storage humidity: RH85%
- Net weight: 112g
- Laser Level: Level 2
- Auto laser off: 20S
- Battery: 2 x 7AAA
- Product Size: 118 x 54 x 26.5mm



0 - 60m 0 - 100m 0 - 150m

Order Code	Measuring Distance (mm)	Accuracy (mm)	Colour	Price RM
TMMU55				
-00060A	0 - 60	±2	Red and Black	428.00
-00100A	0 - 100	±2	Blue and Black	667.10
-00150A	0 - 150	±2	Blue and Black	819.90

Professional Infrared Thermometer

- Measuring range: -25 °C - 400 °C / -13 °F - 752 °F
- Temperature resolution: 1 °C or 2 °F
- Accuracy: -25 °C - 400 °C (± 2% + 1 °C)
- -13 °F - 752 °F (± 2% + 1 °F)
- Spectral response: 8 - 14um
- Object distance ratio (D: S): 10: 1
- Emissivity: 0.95
- Sampling rate: 0.5 S
- Celsius / Fahrenheit - Switchable
- Overload display: -- 0L--
- Automatic data retention and automatic shutdown (Automatic shutdown after 15 seconds)
- White backlit LCD screen
- Working environment: temperature -10 °C - 40 °C, Relative humidity 10% - 80% RH
- Accessories: 1x 9V battery



CE

Order Code	Measuring range	Size (mm)	Weight (g)	Price RM
TMMU65				
-02001T	-25°C - 400°C -13 °F - 752 °F	250 x 190 x 50	240	244.20

High Temperature Infrared Thermometer - Long Object Distance

- Professional-quality, widely used in various industrial fields
- Measuring range: -25 °C - 1000 °C / -13 °F - 1832 °F
- Temperature resolution: 0.2 °C or 0.4 °F
- Accuracy: -25 °C - 1000 °C (± 1.5% + 1 °C)
- -13 °F - 1832 °F (± 1.5% + 1 °F)
- Spectral reaction: 6 - 14um
- Object distance ratio (D: S): 30: 1
- Emissivity: 0.99 / 0.95 / 0.89 / 0.85 / 0.79 / 0.75
- Sampling rate: 0.5 S
- Celsius / Fahrenheit - Switchable
- Overload display: --0L--
- Automatic data retention and automatic shutdown (Automatic shutdown after 15 seconds)
- White backlit LCD screen
- Working environment: temperature 0 °C - 40 °C, Relative humidity 10% - 80% RH
- Accessories: 1 x 9V battery



Order Code	Measuring range	Size (mm)	Weight (g)	Price RM
TMMU65				
-01010T	-25°C - 1000°C -13 °F - 1832 °F	280 x 190 x 70	580	1005.70

Industrial Infrared Thermometers

Features:

- Laser on/off switch function
- LCD with white backlight and Bar graph display
- Celsius and Fahrenheit switchable
- High/Low temperature alarm setting
- Auto power off
- Data recording and data hold function
- Emissivity adjustable
- Room temperature measurement
- MAX/MIN/AVE/DIF reading record function
- Low battery indicator



Specifications:

- Temperature range: -50 to 350°C
- Accuracy: ±1.5% or ±1.5°C
- Resolution: 0.1°C or 0.1°F
- Repeatability: 1% of reading or 1°C
- Response time: 500mSec, 95% response
- Spectral response: 8-14 um
- Emissivity: 0.95 preset (adjustable)
- Distance to spot size: 12 : 1
- Operation temperature: 0 to 50°C (32 to 122°F)
- Operation humidity: 10 to 90%RH
- Storage temperature: -10 to 60°C (14 to 140°F)
- Storage humidity: 10 to 75%RH
- Size: 145x90x35mm
- Weight: 120g (included 9V battery)



Order Code	Measuring range	Size (mm)	Weight (g)	Price RM
TMMU65				
-10750T	-50 ~ 750°C	145 x 90 x 35	120	206.10



MILLING MACHINE	
Face Milling Capacity	25mm
End Milling Capacity	25mm
Drilling Capacity	25mm
Radial Taper	25mm
Spindle Speed	High: 100-2000 rpm Low: 100-1000 rpm
Power	600W
Voltage	220-240V
Weight	17.5kg

TEMO®

Workshop Equipment & Tools

www.temomalaysia.com

Industrial Self Protection Vacuum Cleaners

- Independent operation with By Pass motor cooling cycle system and negative pressure circulation system, which effectively avoid motor failure due to dust entering the motor when vacuuming.
- Advanced air duct design, quieter than ordinary vacuum cleaners
- With smart alarm function - When the dust is blocked, there are flash alarm & sound prompt, indicates that the dust in the barrel is full and must be cleaned and maintained in time.
- Built-in safety device - When the motor temperature is too high, the current is unstable, the safety device is automatically activated and motor shutdown protection.

20L/1000W Industrial Self Protection Wet & Dry Vacuum Cleaners

- Type: Self-protection, wet and dry dual use
- Vacuum bucket material: High quality engineering plastic PP
- Rated voltage: 220V 50/60Hz
- Rated power: 1000W (Max: 1200W)
- Vacuum pressure: 171 mbar
- Motor air volume: 70L/S
- Filtration area: 3600 Sq.cm
- Filtering effect: 99.80%
- Filtering accuracy: 0.3um
- Vacuuming bucket capacity: 20L
- Dust / Water capacity: 20L/8L
- Body size: 390 x 390 x 480mm
- Body weight: 8.5kg



Standard Accessories :

- 1 x 1.75m flexible suction hose.
- 1x Extension tube. • 1 x Hand-held lance.
- 1 x floor brush . • 1 x Crevice tools .
- 1 x squeegee tool.



Spare filter element

Price / RM

Order Code: **TMAT71-10001P**

244.80

Order Code	Power Plug	Price
TMAT71	Standard	RM
-10020B	British	1800.20

32L/1100W Industrial Self Protection Wet & Dry Vacuum Cleaners

- Type: Self-protection, wet and dry dual use
- Vacuum bucket material: High quality engineering plastic PP
- Rated voltage: 220V 50/60Hz
- Rated power: 1100W (Max: 1300W)
- Vacuum pressure: 250 mbar
- Motor air volume: 53L/S
- Filtration area: 3600 Sq.cm
- Filtering effect: 99.80%
- Filtering accuracy: 0.3um
- Vacuuming bucket capacity: 32L
- Dust / Water capacity: 27L/20L
- Body size: 390 x 450 x 590mm
- Body weight: 9.5kg



Standard Accessories :

- 1 x 1.75m flexible suction hose.
- 1x Extension tube. • 1 x Hand-held lance.
- 1 x floor brush . • 1 x Crevice tools .
- 1 x squeegee tool.



Spare filter element

Price / RM

Order Code: **TMAT71-10001P**

244.80

Order Code	Power Plug	Price
TMAT71	Standard	RM
-10032B	British	1987.00

45L/1200W Professional Dry & Wet Vacuum Cleaner(Stainless Steel Tank)

- Type self-protection , wet and dry dual use.
- Vacuum bucket material : Stainless Steel .
- Rated voltage :220V 50/60Hz
- Rate power : 1200W
- Vocuum pressure 22kPa
- Motor air volume : 177m3/h
- Filtration area : 3600 sq.cm.
- Filtering effect 99.8%
- Fitering accuraccy : 0.3um.
- Vacuuming bucket capacity : 45L
- Dust/Water capacity : 40/33L
- Body size : 485 x 484 x 893mm.
- Body weight : 16.5kgs



Standard Accessories :

- 1 x 3.2m flexible suction hose.
- 1x Stainless steel Extension tube.
- 1 x Hand-held lance.
- 1 x floor brush . • 1 x Crevice tools .
- 1 x squeegee tool.
- 1 x round floor brush



Spare filter element

Price / RM

Order Code: **TMAT71-10001P**

244.80

Order Code	Power Plug	Price
TMAT71	Standard	RM
-10045B	British	3719.40

60L/2400W Professional Dry & Wet Vacuum Cleaner(Stainless Steel Tank)

- Type : wet and dry dual use,with Trolley for easy movement.
- Vacuum tank material : Stainless Steel .
- Twin motor, independent swith, each motor can be started separately or simultaneously.
- Rated voltage :220V 50/60Hz
- Rate power : 2400W
- Vacuum pressure 22kPa
- Motor air volume : 177-354m3/h
- Filtration area : 8900 sq cm.
- Filtering effect 99.8%
- Fitering accuraccy : 0.3um.
- Vacuuming bucket capacity : 60L
- Dust/Water capacity : 57/50L
- Body size : 607 x 580 x 1025mm
- Body weight : 26.0kgs



Order Code	Number of Motor	Power Plug Standard	Price RM
TMAT71-30060B	2	British	3795.10

Standard Accessories :

- 1 x 2.5m flexible suction hose.
- 2 x S shape Extension tube.
- 1 x Hand-held lance. • 1 x round floor brush.
- 1 x round suction nozzle.
- 1 x Crevice tools . • 1 x squeegee tool.



Spare filter element

Order Code:	Price RM
TMAT71-30002P	279.40

Spare cloth bag

Order Code:	Price RM
TMAT71-30001P	302.70

80L/2400W Professional Dry & Wet Vacuum Cleaner(Stainless Steel Tank)

- Type : wet and dry dual use,with Trolley for easy movement.
- Vacuum tank material : Stainless Steel .
- Twin motors, independent swithes , each motor can be started separately or simultaneously.
- Rated voltage :220V 50/60Hz
- Rate power : 2400W
- Vacuum pressure 22kPa
- Motor air volume : 177-354m3/h
- Filtration area : 8900 sq cm.
- Filtering effect 99.8%
- Fitering accuraccy : 0.3um.
- Vacuuming bucket capacity : 80L
- Dust/Water capacity :80L
- Body size : 607 x 580 x 1025mm .
- Body weight : 26.0kgs



Order Code	Number of Motor	Power Plug Standard	Price RM
TMAT71-30080B	2	British	4028.00

Standard Accessories :

- 1 x 2.5m flexible suction hose.
- 2 x S shape Extension tube.
- 1 x Hand-held lance. • 1 x round floor brush.
- 1 x round suction nozzle.
- 1 x Crevice tools . • 1 x squeegee tool.



Spare filter element

Order Code:	Price RM
TMAT71-30002P	279.40

Spare cloth bag

Order Code:	Price RM
TMAT71-30001P	302.70

80L/3600W Professional Dry & Wet Vacuum Cleaner(Stainless Steel Tank)

- Type : wet and dry dual use,with Trolley for easy movement.
- Vacuum tank material : Stainless Steel .
- Three motors, independent swithes, each motor can be started separately or simultaneously.
- Rated voltage :220V 50/60Hz
- Rate power : 3600W
- Vacuum pressure 22kPa
- Motor air volume : 177-354m3/h
- Filtration area : 8900 sq cm.
- Filtering effect 99.8%
- Fitering accuraccy : 0.3um.
- Vacuuming bucket capacity : 80L
- Dust/Water capacity :80L
- Body size : 700 x 580 x 1125mm .
- Body weight : 32.8kgs



Order Code	Number of Motor	Power Plug Standard	Price RM
TMAT71-31080B	3	British	4726.40

Standard Accessories :

- 1 x 2.5m flexible suction hose.
- 2 x S shape Extension tube.
- 1 x Hand-held lance. • 1 x round floor brush.
- 1 x round suction nozzle.
- 1 x Crevice tools . • 1 x squeegee tool.



Spare filter element

Order Code:	Price RM
TMAT71-30002P	279.40

Spare cloth bag

Order Code:	Price RM
TMAT71-30001P	302.70

Parts Washers

- Clean grease and grime from tools and automotive components with this parts washer.
- It comes with a removable work shelf and a parts basket for easier organization
- 20 and 40 gallon working capacity, this parts washer is designed for fast and efficient cleaning of vehicle parts and sub-assemblies
- It includes a fusible linked fire cover for maximum operator safety
- Steel construction , resists corrosion, ensuring a long-serving life span



Picture 2



Picture 3

Order Code	Capacity (G)	Dimensions (mm)	Weight (kg)	Picture	Price RM
TMWS09-40200B	20	790 x 550 x 320	26	2	1250.00
TMWS09-40400B	40	1140 x 550 x 330	45	3	1850.00

Sandblast Cabinets

- This heavy duty blast cabinet is constructed of high quality steel plate , powder coat finish.
- Wide side door opening and large viewing window make this blast cabinet ideal for cleaning parts ,
- Pedestal Sandblasting cabinet, is ideal for the processing of small to medium sized workpieces
- The sturdy yet compact design of our cabinets ensures that a minimal amount of space and resources are required for simple, convenient blasting.
- Fluorescent bulbs fitted.
- Overall dimensions : 875 x 630 x 1350 mm
- Work area : 840 x 550 x 580 mm

Pedestal - Side Entrance Door



Order Code	Capacity (L)	Gross Weight (kg)	Net Weight (kg)	Price RM
TMWS09-30260A	260	43.0	47.0	3105.80

Mini DC MMA inverter (Arc welding machine)

- Artificial metal (electrode) arc welding method
- Small size, light weight , energy saving, stable arc, small spatter.
- High welding quality, deep penetration, good welding strength.
- Built-in protection circuits for overcurrent, overheating, overvoltage, etc., safe and reliable to use
- Suitable for welding various metal materials such as aluminum and aluminum alloy, carbon steel, stainless steel, copper, etc.
- Metal body
- Suitable for all kinds of general electrodes
- Portable plastic box packaging, can meet all kinds of urgent needs at any time



Product Specifications	Order Code	Price RM
	TMMC55-10100V	1386.60
Parameters rated voltage	230V	
Rated power	3.4KVA	
Input voltage frequency	50/60HZ	
No-load voltage	76V	
Output current	10-100A	
Rated output voltage	24.4V	
Duty cycle	15%	
Efficiency	85%	
Insulation class	F	
Weight	6.5kgs	
Packaging size	400x370x160mm	
Protection class	IP21	
Electrode diameter	1.6-3.2mm	

MIG-200 Inverter

- Advanced IGBT inverter technology, high efficiency and high duty cycle.
- Small size, light weight , energy saving, stable arc, small spatter.
- High welding quality, deep penetration, good welding strength.
- Built-in protection circuits for overcurrent, overheating, overvoltage, etc., safe and reliable to use
- Suitable for welding various metal materials such as aluminum and aluminum alloy, carbon steel, stainless steel, copper, etc.
- Metal body, air cooled.
- Suitable for all kinds of general and fluc core wire.
- Supplied with : 1 x1.8m cable . 1 x 2.5m torch , 1 x 1.5m earth cable with clamp, 1 x hand shield , 1 x hand brush.



Optainal accessories :
Co2 Regulator ,
MIG Wire.



Price
RM

Product Specifications	Order Code TMMC50-21200B	Price RM
Model	MIG-200N	2818.50
Parameters rated voltage	230V	
Rated power	6.1KVA	
Input voltage frequency	50/60Hz	
No-load voltage	76V	
Output current	20-200A	
Rated output voltage	62V	
Efficiency	60%	
Weight	8.8 kgs	
Packaging size	395x165x300mm	
Protection class	IP21S	
Wire diameter	0.8-2.2mm	

TIG-200 Arc Welder

- Advanced IGBT inverter technology, high efficiency and high duty cycle.
- Switchable between TIG or MMA welding modes.
- Small size, light weight , energy saving, stable arc, small spatter.
- High welding quality, deep penetration, good welding strength.
- Built-in protection circuits for overcurrent, overheating, overvoltage, etc., safe and reliable to use
- Suitable for welding various metal materials such as aluminum and aluminum alloy, carbon steel, stainless steel, copper, etc.
- Metal body, air cooled.
- Suitable for all kinds of general and fluc core wire.
- Supplied with : 1 x 4m TIG torch, 1 x 1.8/200A welding cables , 1 x 1.5m earth cable with clamp, 1 x hand shield , 1 x hand brush.



Optainal accessories :
Argon Regulator



Price
RM

Product Specifications	Order Code TMMC51-21200D	Price RM
Model	TIG-200	2198.10
Parameters rated voltage	230V	
Rated power	7.1KVA	
Input voltage frequency	50/60Hz	
No-load voltage	76V	
Output current	10-200A	
Rated output voltage	62V	
Efficiency	60%	
Weight	6.9 kg	
Packaging size	381x154x290mm	
Protection class	IP21S	

CUT-40 Inverter Plasma

- Advanced inverter technology, high efficiency and high duty cycle.
- Non-contact start system.
- Small size, light weight , energy saving, stable.
- Excellent cutting travel speed
- Built-in protection circuits for overcurrent, overheating, overvoltage, etc., safe and reliable to use
- Suitable for cutting of various metal materials such as aluminum alloy, carbon steel, stainless steel, copper, etc.
- Metal body, air cooled.
- Supplied with : 1 x 5m cutting torch, 1 x 200A earth clamp, 1 x 16-25mm check valve , 1 x hand shield , 1 x hand brush.



Optainal accessories :
Filter Regulator



Price
RM

Product Specifications	Order Code TMMC57-21040C	Price RM
Model	CUT-40	2274.20
Parameters rated voltage	230V	
Rated power	4.8KVA	
Input voltage frequency	50/60Hz	
No-load voltage	76V	
Output current	10-200A	
Rated output voltage	10-40A	
Cutting Thickness	12mm	
Efficiency	85%	
Weight	8.2 kg	
Packaging size	400x151x300mm	
Protection class	IP21S	

Car Battery Chargers

CB-30



Price
RM
850.30

Product Specifications	Order Code TMET80-30030A
Model	CB-30
Parameters rated voltage	230V
Rated power	92-250AH
Input voltage frequency	50/60Hz
Rated output voltage	20A
Charging Voltage	12/24V
Charging current	30A
Weight	9.4 kg
Packaging size	281x220x195mm
Protection class	IP21S

**Car Battery Chargers
with Jump Starter Features**

CD-30R



Price
RM
935.40

Product Specifications	Order Code TMET80-30030B
Model	CD-30R
Parameters rated voltage	230V
Rated power	92-250AH
Input voltage frequency	50/60Hz
Rated output voltage	20A
Charging Voltage	12/24V
Charging current	30A
Weight	8.3 kg
Packaging size	334x261x23mm
Protection class	IP21S

Industrial Battery Booster Cables

- Made of high quality copper cables, designed for the professional use.
- Can be used on a wide variety of vehicles applications. Trucks, Buses, Coaches , construction machine and vehicles.
- Crocodile clips are fully insulated for optimal performance.
- Comply with European GS standards.



Order Code	Rated current (A)	Wire Diameter (mm ²)	Line Length (mm)	Price RM
TMOT05				
-00035A	350	25	3.5	154.30

Automatic Classical Welding Helmets

Product Specifications.

- Made of durable high impact PP materials. Ligth State : DIN4.
- Variable shade : from DIN9-13.
- Reaction time : < 0.1ms (under normal temperature)
- Dimensions : 110 x 90 x 8mm
- View size : 92 x 42mm
- Delay time : Long / Middle (variable from 0.2s / 0.60s)
- Sensors : Auto detected.
- Power supply : Solar Cell + CR2450 lithium battery.
- Protect against UV and IR.
- Comply with CE ANSI ROHS LA standards.
- Witght : 430g.



Order Code	Model	Price RM
TMWD10		
-00127A	Flame Black	275.50
-08511A	Classical Blue	231.40

**Professional Automatic Breathable
Black Welding Helmet**

Product Specifications.

- Made of durable high impact Nylon materials. Ligth State : DIN4.
- Variable shade : from DIN9-13.
- Reaction time : < 0.04ms (under normal temperature)
- Dimensions : 110 x 90 x 8mm
- View size : 92 x 42mm
- Delay time : Long / Middle (variable from 0.15s / 0.80s)
- Sensors : Auto detected.
- Power supply : Solar Cell + CR2450 lithium battery.
- Protect against UV and IR.
- Comply with CE . EN379 standards.
- Witght : 490g.



Order Code	Model	Price RM
TMWD10		
-07511A	Black Breathable	297.60

4 Way Industrial Cable Reels

British Standard

- High impact resistant drum made of high strength PP plastic, anti-fall, anti-drop
- 4 British standard socket
- Overheating protection
- KEMA-BS certification
- RoHS and REACH standard



Order Code	Voltage (V)	Cable length (m)	Net weight (kg)	Price RM
TMET80				
-14015A	240	15	3.0	292.20

3-Way Waterproof Bristish Standard

- High Impact resitant drum made of high strength PP plastic , anti-fall , anti-drop.
- 3 British standard socket with water resistant cap.
- 3 x1.25mm double-insulated high-quality copper core with overheat and overload protective functions
- Comply with BS61242 & BS1363 standar.



Order Code	Voltage (V)	Cable length (m)	Net weight (kg)	Price RM
TMET80				
-14115A	240	15	3.26	373.60
-14125A	240	25	4.35	470.60
-14150A	240	50	7.48	697.00

Industrial Magnetic Drilling Machines

- Used in mining / energy, bridge construction, railway construction, shipbuilding, heavy equipment, steel structure, large machinery manufacturing and equipment maintenance and repair industries
- Helical gear design, can switch high speed or low speed in rotation, reduce friction, extend gear lifespan
- Twist drill can be used by changing the adapter
- Dual coil magnetic seat, the drilling position more accurate, more safe
- Ball bearing support frame design to reduce wear and reduce spindle shank vibration, can greatly extend the lifespan of magnetic drill and motor
- Electronic switch design, better stability than the traditional push-type switch
- With accessories

Magnetic drill see page P29-P32



Order Code	Types	Max Diameter (mm)	Rated voltage (V)	Rated power (W)	No-load speed (rpm)	Stroke (mm)	Magnetic adhesion (kg)	Magnet size (mm)	Size W x D x H(mm)	Weight (kg)	Price RM
-10035A	Single speed	35	220	1100	780	100	750	186 × 80 × 58	188 × 85 × 390	14	11135.80
-10060B	Two-speed	60	220	1850	450-750	135	2300	210 × 100 × 64	210 × 100 × 540	23	17672.90

Multi-functional Magnetic Drilling / Tapping Machine

- Used in mining, energy, bridge construction, railway construction, shipbuilding, heavy equipment, steel structure, large machinery manufacturing, equipment maintenance and repair industries
- High power, small size, ultra-light
- Coolant and lubricating fluid integrated device
- Soft start, 3 stage gear with variable speed regulation
- Can use tap and twist drill by changing adapter
- Overload protection
- Solid brass rail frame to ensure sliding head move smoothly up and down
- Rated voltage: 220V
- Input power: 2280W
- With accessories

Magnetic drill see page P29-P32



Order Code	Magnetic drill (mm)	Twist drill (mm)	Tapping (mm)	Reaming (mm)	Chamfer (mm)	No-load speed (rpm)	Stroke (mm)	Max suction (N)	Size W x D x H(mm)	Price RM
-20085C	85	32	27	32	40	0 - 200/330/410	250	16800	430 × 210 × 550	12527.10

Heavy Duty Magnetic Drilling Machines

- Used in mining, energy, bridge construction, railway construction, shipbuilding, heavy equipment, steel structure, large machinery manufacturing, equipment maintenance and repair industries
- Super magnetism, stable work
- Suitable for processing soft and hard materials
- Wave pattern design handle, more comfortable grip and more secure
- Simple operation, high efficiency
- Rated voltage: 380V
- With accessories

Magnetic drill see page P29-P32



Order Code	Magnetic drill (mm)	Twist drill (mm)	Input power (mm)	No-load speed (r/min)	Stroke length (mm)	Max suction (N)	Size W x D x H(mm)	Price RM
-30120H	120	5 - 32	2000	150 / 280	250	16000	430 × 180 × 550	6637.30
-30130H	130	5 - 38	2100	135 / 250	250	16500	430 × 180 × 550	7054.70
-30140H	140	5 - 49	2300	120 / 220	250	17500	430 × 180 × 550	7472.20
-30180H	180	5 - 60	2600	105 / 210	300	22000	430 × 210 × 600	11437.90

Industrial Milling / Drilling Machine - Variable Speeds

- Industrial high quality and reliable
- Variable Speed



TMMC40-11020B

TMMC40-11045B

Parameters	Order Code	Price RM	Order Code	Price RM	Order Code	Price RM	Order Code	Price RM
	TMMC40-11020B	11688.40	TMMC40-11021B	13149.30	TMMC40-11035B	28177.20	TMMC40-11045B	40909.10
Drill diameter (mm)	20		20		35		45	
Face milling diameter (mm)	63		63		75		80	
Milling diameter (mm)	20		20		30		32	
Spindle taper	MT2 / MT10		MT2 / MT10		MT3 / SK30		MT4 / SK40	
Spindle speed	Low speed: 90 - 1480rpm High speed: 150 - 3000rpm		Low speed: 90 - 1480rpm High speed: 150 - 3000rpm		Low speed: 100 - 1100rpm Middle speed: 160 - 1700rpm High speed: 320 - 3100rpm		Low speed: 115 - 600rpm Middle speed: 270 - 1400rpm High speed: 590 - 3100rpm	
Table (LxW) (mm)	500 x 180		700 x 180		750 x 210		850 x 240	
Y-axis travel (mm)	175		175		450		500	
X-axis travel (mm)	280		480		200		260	
Z axis travel (mm)	280		280		470		540	
T-slot size / distance / number	12mm / 63mm / 3		12mm / 63mm / 3		12mm / 63mm / 3		18mm / 80mm / 3	
Motor Power	850W		850W		2.2KW Brushless DC motor		2.2KW Brushless DC motor	
Package size (LxWxH) (mm)	606 x 554 x 917		770 x 714 x 917		844 x 844 x 1342		904 x 904 x 1535	
Net weight / gross weight (kg)	103 / 130		112 / 139		266 / 318		426 / 492	

5-Speed Mini Bench Drill

- High power motor, high-precision spindle, reliable quality, high efficiency.
- Max drilling capacity: 13mm
- Column diameter: 40mm
- Spindle travel: 50mm
- Spindle taper: B16
- Distance Spindle to Column: 104mm
- Table size (length x width): 160 x 160mm
- Max Distance Spindle to Worktable: 200mm
- Base size (length x width): 200 x 314mm
- Max Distance Spindle to Base: 290mm
- Motor power: 350W
- Package Size (L x W x H): 400 x 255 x 545mm
- Standard accessories: Drill chuck, drill rod
- CE, EMC certification



Order Code	Numbers of Speed	Spindle speed (rpm)	Net weight (kg)	Gross weight (kg)	Price RM
TMMC20					
-00131B	5	580 - 2650	19	21	1516.20

Variable Speed Bench Drills

- High power motor, high-precision spindle, reliable quality, high efficiency.
- Max drilling capacity: 16mm
- Column diameter: 42mm
- Spindle travel: 60mm
- Spindle taper: MT2
- Distance Spindle to Column: 126mm
- Worktable size (length x width): 200 x 195mm
- Max Distance Spindle to Worktable: 350mm
- Base size (length x width): 355 x 235mm
- Max Distance Spindle to Base: 524mm
- Motor power: 450W
- Package Size (L x W x H): 440 x 270 x 680mm
- Standard accessories: Drill chuck, drill rod
- CE, EMC certification



Order Code	Numbers of Speed	Spindle speed (rpm)	Net weight (kg)	Gross weight (kg)	Price RM
TMMC20					
-00161B	12	220 - 2450	38	40	3195.90
-00162B	5	660 - 2500	38	40	3463.90

12-Speed Bench Drill

- High power motor, high-precision spindle, reliable quality, high efficiency.
- Max drilling capacity: 20mm
- Column diameter: 47mm
- Spindle travel: 80mm
- Spindle taper: MT2
- Distance Spindle to Column: 169mm
- Table size (length x width): 300 x 300mm
- Max Distance Spindle to Worktable: 390mm
- Base size (length x width): 425 x 295mm
- Max Distance Spindle to Base: 640mm
- Motor power: 550W
- Package Size (L x W x H): 520 x 315 x 820mm
- Standard accessories: drill chuck, drill rod
- CE, EMC certification



Order Code	Numbers of Speed	Spindle speed (rpm)	Net weight (kg)	Gross weight (kg)	Price RM
TMMC20-00201B	12	210 - 2220	53	56	3850.90

Auto-Feed Floor Standing Pillar Drill - Gear Drive

- Automatic feed, gear drive, 12-speed gear
- Unique and easy blade loading and unloading device, with cooling, protection device
- Swivel of Headstock On Either Side: ± 45 °
- Swivel of Worktable On Either Side: ± 45 °
- Max drilling diameter: 32mm
- Max tapping diameter: M20
- Max Spindle travel: 160mm
- Distance Spindle to Column: 350mm
- Max Distance Spindle to Worktable: 850mm
- Distance Spindle to Base: 1400mm
- Max Travel Worktable to Carriage: 550mm
- Worktable rotation angle: ± 45 °
- Spindle taper hole (Mohs): MT4
- Spindle feed stage: 3
- Spindle speed series and range: 12 (65-2600rpm)
- Worktable effective working area: 450 x 390mm
- Base effective working area: 405 x 395mm
- Main column diameter: 120mm
- Cooling pump flow: 6L / min
- Rated voltage: 380V
- Motor power: 1 / 1.5kw
- Packing size: 1030 x 610 x 2090mm
- Net weight: 500kg



Order Code	Gross weight (kg)	Price RM
TMMC20-21032F	500	30201.40

Bench Milling / Drilling Machine

- Metal processing machinery, Widely used in various industrial fields
- Milling machine features: 1500W brushless motor
- Technical parameters:
 - Max drilling capacity: 30mm
 - Max tapping capacity: 16mm
 - Max face milling capacity: 40mm
 - Max surface milling capacity: 55mm
 - Headstock travel (Z): 335mm
 - Horizontal travel (Y): 245mm
 - Longitudinal travel (X): 450mm
 - Distance Spindle to Column: 290mm
 - Max Distance Spindle to Workbench: 430mm
 - Spindle taper: MT4
 - Motor output power: 1500W brushless motor
 - Spindle speed range (variable speed): 100-1600 ± 10% rpm
 - Workbench effective size: 820 x 240mm
 - Headstock swivel angle: 45 ° left and right
 - T-slot size: 14mm
- Accessories: 16mm Drill Chuck, Wrenches, Oil Cans



Order Code	Net Weight (kg)	Dimensions (mm)	Price RM
TMMC40 -00030D	310	(L)1060 x (W)840 x (H)1160	36546.90

Micro Milling / Drilling Machine

- Metal processing machinery, Widely used in various industrial fields
- Technical parameters:
 - Max drilling capacity: 10mm
 - Max face milling capacity: 10mm
 - Max surface milling ability: 16mm
 - Headstock travel (Z): 190mm
 - Horizontal travel (Y): 105mm
 - Longitudinal travel (X): 200mm
 - Max Distance Spindle Center to Column: 140mm
 - Max Distance Spindle end to Workbench: 260mm
 - Spindle taper: MT2
 - Motor output power: 150W
 - Spindle speed range (variable speed regulation):
 - Low speed 0-1000 ± 10% rpm
 - High speed 0-2000 ± 10% rpm
 - Workbench effective size: 240 x 145mm
 - T-slot size: 8mm
- Accessories: 10mm Drill Chuck, Wrenches, Oil Cans
- Options: 24-piece M6 Clamping Kits (Order No. TMMC40-00004P) See page P87 for details

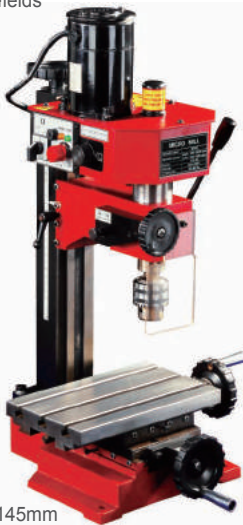

Order Code	Net Weight (kg)	Dimensions (mm)	Price RM
TMMC40 -00010A	32	(L)390 x (W)360 x (H)600	6696.80

Small Milling / Drilling Machine

- Metal processing machinery, Widely used in various industrial fields
- Technical parameters
 - Max drilling capacity: 20mm
 - Max face milling capacity: 16mm
 - Max surface milling ability: 50mm
 - Headstock travel (Z): 290mm
 - Horizontal travel (Y): 190mm
 - Longitudinal travel (X): 395mm
 - Distance Spindle to Column: 190mm
 - Max Distance Spindle to Workbench: 370mm
 - Spindle taper: MT3
 - Motor output power: 750W
 - Spindle speed change range: 100-2000 ± 10% rpm
 - Workbench effective size: 595 x 140mm
 - T-slot size: 12mm
- Accessories: 13mm Drill Chuck, Wrenches, Oil Cans
- Options: 42 sets of M10 Clamping Kits (Order number: TMMC80-31012M or TMMC80-31014M)



Order Code	Net Weight (kg)	Dimensions (mm)	Price RM
TMMC40 -00020E	101	(L)725 x (W)620 x (H)880	18367.40

Small Milling / Drilling Machine

- Metal processing machinery, widely used in various industrial fields
- Technical parameters
 - Max drilling capacity: 25mm
 - Max face milling capacity: 16mm
 - Max surface milling ability: 50mm
 - Headstock travel (Z): 300mm
 - Horizontal travel (Y): 145mm
 - Longitudinal travel (X): 400mm
 - Distance Spindle to Column: 230mm
 - Max Distance Spindle to Workbench: 380mm
 - Spindle taper: MT3
 - Motor output power: 600W
 - Spindle speed range (variable speed regulation):
 - Low speed 100-1000 ± 10% rpm
 - High speed 100-2000 ± 10% rpm
 - Worktable effective size: 550 x 160mm
 - T-slot size: 12mm
- Accessories: 13mm Drill Chuck, Wrenches, Oil Cans
- Options: 42 sets of M10 Clamping Kits (Order number: TMMC80-31012M or TMMC80-31014M)



Order Code	Net Weight (kg)	Dimensions (mm)	Price RM
TMMC40 -00025B	165	(L)720 x (W)760 x (H)990	18158.70

Mini Milling / Drilling Machine

- Metal processing machinery, widely used in various industrial fields
- Milling machine features:
500W brushless motor
- Column tilts to 45° left & right for inclined holes
- Technical parameters:
Max drilling capacity: 16 mm
Max end milling diameter: 20 mm
Max face milling diameter: 35 mm
Longitudinal travel (X): 220 mm
Horizontal travel (Y): 100 mm
Headstock travel (Z): 180 mm
Distance Spindle to Column: 167 mm
Spindle taper: MT3 or R8
Workbench effective size:
390x92mm
T-slot size: 8 mm
Motor output power: 500W
Spindle speed: 100-2500rpm
- Options: 24-piece M6 Clamping Kits (Order number: TMMC40-00004P) See details on this page



Order Code	Net weight (kg)	Gross weight (kg)	Dimensions (mm)	Price RM
TMMC40				
-02016C	50	68	(L)520 x (W)510 x (H)760	10319.10

Optional accessories are as follows: Quick vises



Order Code	Jaw width (mm)	Package Size (mm)	Price RM	Suitable for Milling Machine Order number TMMC40
TMMC40				
-00001P	50	145 x 80 x 55	416.60	-00010A / -01016C
-00005P	100	275 x 120 x 90	705.30	-00020E / -00025B

Quick Swivel Machine Vises



Order Code	Jaw width (mm)	Package Size (mm)	Price RM	Suitable for Milling Machine Order number TMMC40
TMMC40				
-00002P	55	230 x 200 x 140	810.00	-00010A / -01016C
-00006P	80	290 x 220 x 150	1146.10	-00020E / -00025B

8Pc Double Angle Collet Sets

Order Code	Chuck Size Model	Chuck Size (mm)	Price RM	Suitable for Milling Machine Order number TMMC40
TMMC40				
-00003P	MT2	3/4/5/6/8/10	1362.10	-00010A
-00007P	MT3	4/6/8/10/12/14/16	1454.70	-00020E / -00025B / -01016C

24Pc Clamping Kit

- Specifications:
4 x Engineers Studs, 4 x Step Blocks
4 x Step Clamp, 4 x T-Slot Nuts,
4 x Extension Nuts, 4 x Flanged nuts



Order Code	Thread Size	Price RM	Suitable for Milling Machine Order number TMMC40
TMMC40			
-00004P	M6	462.90	-00010A / -01016C

250W Mini Metalworking Lathes

- Metal processing machinery, widely used in various industrial fields
- Lathe features: safety switch, variable speed regulation, four-positioning turret, With overload protection, a full set of exchange gear
- Technical parameters:
Swing over bed diameter: 180mm
Hole through spindle diameter: 20mm
Spindle taper: MT3
Tailstock taper: MT2
Spindle speed:
Low speed 100-1100 ± 10% rpm; high speed 100-2500 ± 10% rpm
Pallet horizontal travel: 65mm
Motor output power: 250W
Thread Range: Metric 0.4 - 2.0mm (10 thread pitches)
- Accessories:
80mm 3 Jaw Chuck, MT2 Solid Centres, Exchange gear kit, Wrench kit, Oil Cans

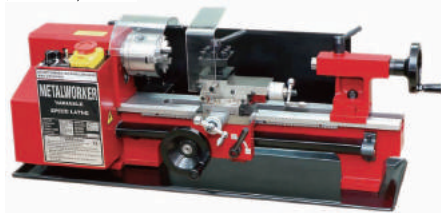

Order Code	Distance between centres (mm)	Lathe dimensions (mm) (L x H x W)	Net weight (kg)	Price RM
TMMC41				
-10200A	200	600 x 300 x 300	33	6912.80
-10300A	300	700 x 300 x 300	37	7739.30

350W Mini Metalworking Lathe

- Metal processing machinery, widely used in various industrial fields
- Lathe features: spindle speed display, brushless motor, safety switch, variable speed regulation, four positioning turret, With overload protection, a full set of exchange gear
- Technical parameters:
Swing over bed diameter: 180mm
Hole through spindle diameter: 20mm
Spindle taper: MT3
Tailstock taper: MT2
Spindle speed:
Low speed 100 - 1200 ± 10% rpm; High speed 100 - 3000 ± 10% rpm
Pallet horizontal travel: 65mm
Motor output power: 350W
Thread Range: Metric 0.4 - 2.0mm (10 thread pitches)
- Accessories:
80mm 3 Jaw Chuck, MT2 Solid Centres, Exchange gear kit, Wrench kit, Oil Cans

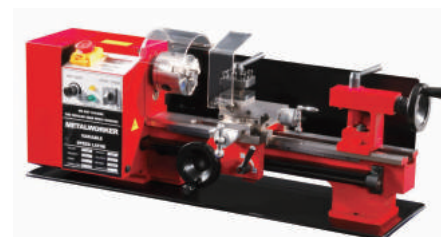

Order Code	Distance between centres (mm)	Lathe dimensions (mm) (L x H x W)	Net weight (kg)	Price RM
TMMC41				
-20350A	350	880 x 290 x 290	44	9674.20

500W Mini Metalworking Lathes

- Metal processing machinery, widely used in various industrial fields
- Lathe features: Brushless motor, safety switches, variable speed regulation, four-position turret, with overload protection, low noise
- Technical parameters:
Swing over bed diameter: 180mm. Hole through spindle diameter: 20mm. Spindle taper: MT3. Tailstock taper: MT2. Spindle speed range: 100 - 2500 ± 10% rpm
Pallet horizontal travel: 65mm. Motor output power: 500W
Thread Range: Metric 0.4 - 2.0mm (10 thread pitches)
- Accessories:
80mm 3 Jaw Chuck, MT2 Solid Centres, Exchange gear kit, Wrench kit, Oil Cans

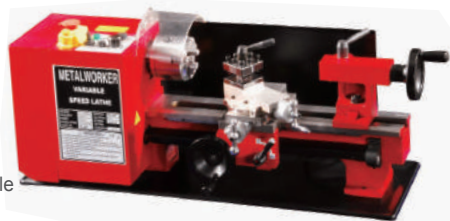

Order Code	Distance between centres (mm)	Lathe dimensions (mm) (L x H x W)	Net weight (kg)	Price RM
TMMC41				
-30300A	300	700 x 300 x 300	44	10104.20
-30350A	350	800 x 300 x 300	50	10319.10

Multi-Purpose Machines

- Multi-function machine with machine tool, drill press and milling machine

Turning technical parameters:

- Swing over bed diameter: 250mm
- Distance between centres: 550mm
- Hole through spindle diameter: 20mm
- Spindle taper: MT3
- Tailstock taper: MT2
- Pallet horizontal travel: 110mm
- Pallet longitudinal travel: 75mm
- **Spindle speed range: Model A: 6 stage: 125 - 2000 rpm; Model B: Variable: 125 - 2000 rpm ± 10%**
- Thread Range: Metric 0.4 - 3.0mm (12 thread pitches); Imperial 10 - 44 TPI (8 thread pitches)
- Motor output power: 550W
- Power: 220V / 50Hz
- Lathe dimensions (LxWxH): 1140 x 600 x 450mm
- Packaging dimensions (LxWxH): 1200 x 640 x 570mm
- Net weight / gross weight: 145 / 180kg
- Individually packing

Drilling and milling technical parameters:

- Max drilling capacity: 13mm
- Headstock travel (Z): 180mm
- Spindle taper: MT2
- Swivel of headstock angle: left 25°, right 45°
- Motor output power: 350W
- Spindle speed range, Low speed: 100 - 1100 rpm ± 10%; High speed: 100 - 2500 rpm ± 10%
- Dimensions (L x W x H): 380 x 360 x 850mm
- Packaging dimensions (L x W x H): 760 x 380 x 460mm
- Net weight / gross weight: 30 / 42kg
- Individually packing

Standard accessories:

- 125mm 3 Jaw Chuck, 13mm Drill Chuck
- Exchange gear kit, MT2 Solid Centres
- MT3 Solid Centres, Milling table, Wrench kit
- Other accessories, please consult

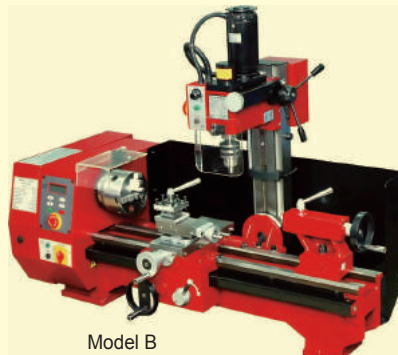
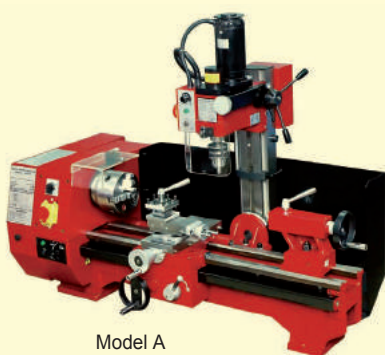

Order Code	Model	Speed Change	Price RM
TMMC42			
-00106A	A	6 stage	20767.60
-00206B	B	Variable Speed	26298.70

Industrial Bench Grinders

- Heavy duty industrial bench grinder, with long service lifespan and maintenance-free motor
- Die-cast aluminum housing.
- The rotor is dynamically balanced and equipped with high-quality rolling bearings for smoother operation
- Safety shield to prevent spark splashing
- Protection level: IP20
- Equipped with 2 grinding wheel
- Optional: Grinder Stands



Order Code	Grinding Wheel Diameter	Voltage	Motor	Package Size (mm)	Gross weight (kg)	Price RM
TMMC60						
-41500A	150(6") x 25 x 32	230V~50Hz (1)	500W S2=30min; 2850rpm	485 x 258 x 220	19	1466.00
-42000A	200(8") x 32 x 32	380V~50Hz (3)	900W S2=30min; 2850rpm	540 x 300 x 275	28	2274.00

Professional Full Drop Forged Steel Bench Vises

- All forged steel structure, the tensile strength of the composite structure is 10 times more than ordinary vises with high-strength clamping force
- The side of the anvil is equipped with precision adjusting device to ensure the accurate operation of the moving jaws
- Integrated pattern jaws, strong clamping force, smooth operation
- Heat treated Jaws and Anvil Face, Hardness reached HRC45 - 50, Durable
- 360 ° Swivel Base



Order Code	Jaw Width (mm)	Jaw Opening (mm)	Net Weight (kg)	Price RM
TMWS20				
-10100A	100	100	9	1144.00
-10125A	125	125	13	1564.70
-10150A	150	182	23	2785.90
-10180A	180	200	30	3351.60

Multi-Functional Bench Vise with Swivel Base

- Adopt high-quality cast iron materials
- Powerful clamping force
- 360 ° Swivel Base, 360 ° Swivel Double Jaws
- Large Knockable Anvil
- Suitable for various industries assembly and maintenance

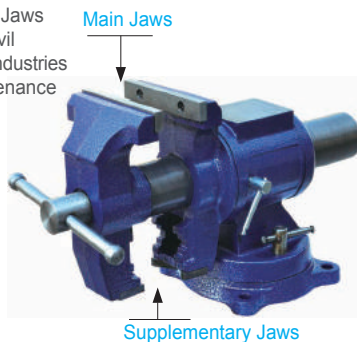

Order Code	Jaw Width (mm)	Jaw Opening (mm)	Net Weight (kg)	Price RM
TMWS22				
- 00125M	125	77	18	973.40

Heavy Duty Bench Vises with Swivel Bases

- Cast iron body
- Solid structure, good rigidity, powerful clamping force
- Knockable Anvil
- Suitable for machinery manufacturing, fitter maintenance and other industries
- GS certification



Order Code	Jaw Width (mm)	Swivel Base	Jaw Height (mm)	Jaw Opening (mm)	Net Weight (kg)	Price RM
TMWS24						
-00075H	75	360°	46	75	6.2	406.30
-00100H	100	360°	61	100	11	548.20
-00125H	125	360°	72	125	19	631.30
-00150H	150	360°	84	150	29	922.10
-00200H	200	360°	102	200	43	1431.00
-00250H	250	120°	107	225	59	2103.20

M Type Precision Bench Vises with Swivel Bases

- Adpot high-quality cast iron materials
- Precision screw, open and close smoothly
- 360 ° Swivelase
- Knockable Anvil

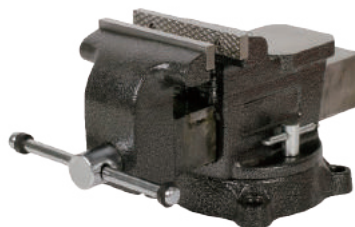

Order Code	Jaw Width (mm)	Jaw Opening (mm)	Net Weight (kg)	Price RM
TMWS23				
-00100P	100	56	75	523.90
-00125P	125	67	100	598.90
-00150P	150	75	125	786.10
-00200P	200	86	150	1148.20

Heavy Duty Universal Bench Vises

- Widely used in various machining and other fields
- Adopt high-quality cast iron materials
- Clamp body, Two-way body, Swivel Slider with tilting mechanism
- 360 ° Swivel Base

Order Code	Jaw Width (mm)	Jaw Height (mm)	Jaw Opening (mm)	Net Weight (kg)	Price RM
TMWS21					
-00105U	105	40	105	26	3459.80
-00125U	125	40	125	30	4000.40



Rail Clamps

- Adjustable locking screw mechanism lets you quickly change the width for quick interchange
- Convenient Hoist Hook attachment point built in.
- Robust steel construction. High quality paint finish.
- Corrosion resistant clamp screw.
- Designed for the harsh oil, gas and mining environments, including:

Oil and Gas, Marine, Steel Mills, Mining, General Fabrication, Construction, and Industrial Maintenance.

The heavy duty rail beam clamps have unusually high capacities to handle the extreme lifting capacities.

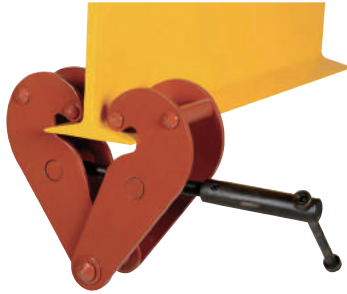

Order Code TMWS10	Capacity (T)	Jaw Opening (mm)	Net Weight (kg)	Price RM
-20010A	1	75 - 220	3.8	600.00
-20020A	2	75 - 220	4.6	646.20
-20030A	3	80 - 320	9.0	880.50
-20050A	5	80 - 320	11.0	963.00
-20100A	10	90 - 320	16.0	1408.50

Chain Hoists

- Suitable for factories, mines, construction sites, piers, docks and warehouses in machines installation, cargo lifting and vehicle handling
- Especially suitable for open-air and no-power operation environment
- Can be used with a variety of hand-cranked monorail vehicles, as composition of hand-lifting transport car. Applicable to monorail overhead transport, manual single-girder overhead traveling cranes and jib cranes
- Forged forming and heat treated hook frame, for safety use and durable
- Thicker shell design, impact resistance
- Double pawl brake, safe and reliable
- Multi-point support structure, flexible operation
- The machine adopts non-slip nut, good safety performance
- Light weight, small size, easy to carry



Capacity (T)	Load Chain Diameter (mm)	No. Columns of Load Chains	3M Lifting		6M Lifting	
			Order Code TMWS10	Price RM	Order Code TMWS10	Price RM
0.5	5.0	1	-10005A	452.60	-11005A	601.30
1.0	6.0	1	-10010A	524.80	-11010A	659.50
1.5	7.1	1	-10015A	689.90	-11015A	838.90
2.0	8.0	1	-10020A	735.70	-11020A	882.50
3.0	7.1	2	-10030A	847.70	-11030A	989.20
5.0	9.0	2	-10050A	1283.00	-11050A	1403.80
10.0	10.0	4	-10100A	2507.60	-11100A	2570.00
15.0	10.0	6	-10150A	4564.30	-11150A	4792.60
20.0	10.0	8	-10200A	5771.20	-11200A	5962.00
30.0	10.0	12	-10300A	14928.00	-11300A	15674.40
50.0	10.0	12	-10500A	61866.70	-11500A	68597.70

Wire Rope Pulling Hoists

- The wire rope pulling hoists is a hand operated lifting and pulling machine, it is operated by means of the forward or backwards levers using the handle supplied with the machine.
- Wire rope pulling hoists are ideal for lifting, pulling & securing loads - they really are a versatile piece of equipment that will help you complete a range of tasks. This wire rope pulling hoists is equipped with replaceable shear pins to prevent overloading, and features a rope clamp system that can be disengaged to install the wire rope easily.
- Designed for the harsh oil, gas and mining environments, including: Oil and Gas, Marine, Steel Mills, Mining, General Fabrication, Construction, and Industrial Maintenance.
- Equipped with safety latches, 20M galvanized wire rope and this guarantees safe operations.



Product descriptions	Order Code: TMWS10		
	-30080A	-30160A	-30320A
Rated Capacity (kg)	800	1600	3200
Lever pull at WLL (N)	284	412	441
Rope advance per Full stroke (mm)	≥52	≥55	≥28
Level length (mm)	825	1200	1200
Rope diameter (mm)	8.3	11	16
Standard wire rope length (M)	20	20	20
Wire rope safety factor	5	5	5
Overload protection ratio	5	5	5
Weight (kg)	6.4	12	23
Price / RM	1603.50	2346.00	3732.00

Lever Blocks

- Suitable for shipbuilding, telecommunications, mining, electricity, transport and other departments during the absence of power to do heavy lifting, equipment installation, mechanical traction and so on
- It can quickly pull the lifting chain at no-load for quick positioning of the hook
- Forged forming and heat treated hook frame, for safety use and durable
- Quick lifting speed, the required force is small
- Light weight, small size, easy to carry



Order Code TMWS11	Capacity (T)	Standard Lift (M)	Load Chain Diameter (mm)	No. Columns of Load Chains	Weight (kg)	Price RM
-10007B	0.75	1.5	6	1	8	509.10
-10010B	1	1.5	6	1	8	524.50
-10015B	1.5	1.5	8	1	12.8	689.90
-10020B	2	1.5	8	1	12.8	745.90
-10030B	3	1.5	10	1	18	1048.80
-10060B	6	1.5	10	1	28.5	1611.40
-10090B	9	1.5	10	1	45	2499.90

Digital Heavy Duty Crane Scales

- 56mm red subtitles display, visual distance $\geq 30m$
- Automatic battery voltage indication at power on / off
- Overload and battery low voltage alarm, to ensure safety use
- Use large capacity battery, can be used for a long time
- Any weight value correction
- Display resolution selection
- Automatic sleep / shutdown, energy-saving design
- Pocket type remote control, easy to operate, more functional



Order Code	Capacity (T)	Test Resolution (Kg)	Display Resolution (Kg)	Display	Price RM
TMWS15					
-01015A	15	5	5/10	30mm LED	7341.70
-01020A	20	10	5/10	30mm LED	8327.90
-01030A	30	10	10	56mm Large LED	21696.40
-01050A	50	20	20	56mm Large LED	41639.60

Stainless Steel Heavy Duty Crane Scales - Wireless Data Transmission

- Stainless steel scale body design, anti-corrosion acid and alkali
- Super capacity storage
- With power-off data protection, remove the battery data will not be lost
- Portable instruments, large-screen LCD display
- Chinese menu operation, all Chinese input
- Comes with high-performance thermal printer, fast printing
- The weight calibration and error adjustment are all operated by the instrument easy and convenient
- Power supply: build-in 6V / 4.5Ah rechargeable battery, run up to 50 hours on a single full charge.
- Wireless transmission distance: Over 200 meters
- Data storage: 1089 times
- Working environment: -30 °C ~ 60 °C high temperature Not higher than 2000 °C \cong 1.8M1600 °C \cong 1.6M
- Optional high temperature insulation type, suitable for smelting casting industry use (consult Temo company)
- Optional instrument (consult Temo company)



Order Code	Capacity (T)	Test Resolution (Kg)	Display Resolution (Kg)	Price RM
TMWS15				
-06015W	15	5	5/10	11724.80
-06020W	20	10	5/10	12491.90
-06030W	30	10	10	27394.50
-06050W	50	20	20	48214.30

Digital Crane Scales

- 30mm red subtitles display, visual distance $> 25m$
- Automatic battery voltage indication at power on / off
- Overload and battery low voltage alarm, to ensure safe use
- Use of large capacity battery, low-power design can be used for a long time
- Any weight value correction
- Display resolution selection
- Automatic sleep / shutdown energy-saving design
- Pocket type remote control, easy to operate, more powerful



Order Code	Capacity (T)	Test Resolution (Kg)	Display Resolution (Kg)	Price RM
TMWS15				
-02001B	1	0.5	0.5	2629.90
-02002B	2	1	0.5	2629.90
-02003B	3	1	1	2629.90
-02005B	5	2	1/2	3024.30
-02010B	10	5	2/5	4536.60

Heavy Duty Spring Balancers

- Suitable for automotive molds, parts welding, assembly line, fixed working stations and concentrated workload, operating heavy tools and longer working hours occasions.
- Whether in the production assembly line or fixed working stations, Any use of tools and lifting equipment occasions can be used, Can also be used as an auxiliary tool to reduce labor intensity
- With the accumulated energy, the coil spring can be used as suspension for the operating tool and greatly reduce the labor intensity, improve labor productivity.
- Thicker steel housing, high tensile strength wire rope and durable



Order Code	Load Capacity		Travel	Price RM
	kg	Lbs		
TMWS16				
-00015A	0.5 ~ 1.5	1.1 ~ 3.3	130mm / 51"	904.80
-00030A	1.5 ~ 3.0	3.3 ~ 6.6	130mm / 51"	1134.80
-00050A	3.0 ~ 5.0	6.6 ~ 11.0	130mm / 51"	1249.60
-00070A	5.0 ~ 7.0	11.0 ~ 15.4	130mm / 51"	1479.50
-00090A	5.0 ~ 9.0	11.0 ~ 19.8	130mm / 51"	2858.70
-00150A	9.0 ~ 15.0	19.8 ~ 33.0	130mm / 51"	2973.50

Digital Floor Scales

Type A with Data Output Function

- Plug-in, power-off dual-use, red digital display
- With tare weight, weight accumulation, weight warning and automatic standby functions
- Can set the upper and lower limit alarm output
- External connection to three-color alarm lights, sound and light alarm
- Metric / Imperial conversion unit: kg / lb
- Number counting function
- Carbon steel scale, stainless steel weighing pan
- External devices: equipped with RS232 interface, can connect to printer or computer

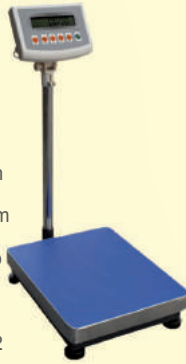

Weighing Surface Size (mm)	Maximum Capacity (kg)	Accuracy (g)	External Devices	Order Code	Price RM
30 x 40	30	2	Equipped with RS232 interface	-10030E	1475.60
40 x 50	60	5	Equipped with RS232 interface	-10060E	1543.70
40 x 50	100	10	Equipped with RS232 interface	-10100E	1543.70
40 x 50	150	10	Equipped with RS232 interface	-10150E	1543.70
40 x 50	300	20	Equipped with RS232 interface	-10300E	1543.70
46 x 60	300	20	Equipped with RS232 interface	-10301E	2224.80
60 x 80	600	100	Equipped with RS232 interface	-10600E	2724.20

Type B



Weighing Surface Size (mm)	Maximum Capacity (kg)	Accuracy (g)	Order Code	Price RM
30 x 40	30	2	-20030E	908.10
40 x 50	60	5	-20060E	953.50
40 x 50	100	10	-20100E	953.50
40 x 50	150	10	-20150E	953.50
40 x 50	300	20	-20300E	953.50
46 x 60	300	20	-20301E	1634.60
60 x 80	600	100	-20600E	2224.80

Type C



Weighing Surface Size (mm)	Maximum Capacity (kg)	Accuracy (g)	Order Code	Price RM
30 x 40	30	2	-30030E	794.60
40 x 50	60	5	-30060E	840.00
40 x 50	100	10	-30100E	840.00
40 x 50	150	10	-30150E	840.00
40 x 50	300	20	-30300E	840.00
46 x 60	300	20	-30301E	1498.30
60 x 80	600	100	-30600E	2020.50

LNC High Precision Electronic Count Scales

- Accuracy: 1/30000
- Charging, plug-in dual-use options to avoid power outages
- Super bright LCD liquid crystal display, the screen with automatic backlight function
- Automatically zero reset and automatic standby function
- With the cumulative number of functions
- HI-LO-OK weight, Number Warning function, and has a memory function
- Optional TP16 / LP50 small printer
- Optional RS-232 computer interface, connect to Windows system



Order Code	Maximum Capacity (kg)	Scale Graduation (g)	Weighing Surface Size (mm)	Price RM
TMWS80				
-01003A	3	0.1	215 x 310	1115.30
-01015A	15	0.5	215 x 310	1115.30

Digital Bench Scales

- Plug-in, power-off dual-use
- With tare weight, weight accumulation, weight warning and automatic standby functions
- Metric / Imperial conversion unit: kg / lb
- Stainless steel weighing surface



Weighing Surface Size (mm)	Maximum Capacity (kg)	Accuracy (g)	Order Code	Price RM
	3	0.1	-02003E	794.60
210 x 288	6	0.2	-02006E	794.60
	15	0.5	-02015E	794.60
	30	1.0	-02030E	794.60

Electronic Balances

- Using the latest ceramic sensor
- White super bright LCD liquid crystal display
- With unit conversion, simple counting, upper and lower limit alarm functions
- Stainless steel weighing surface
- Standard RS232 bidirectional port, can be connected to the computer, can use without software
- Optional: Weight proportion frame for the weight proportion test



Order Code	Weighing Surface Size ø (mm)	Weighing range (g)	Accuracy (g)	Windproof (dust) Cover Size (g)	Weight (kg)	Price RM
TMWS82						
-10100A		120				3746.90
-10200A		200				3967.40
-10300A	115	320	0.001	180 x 180 x 230	5.5	4187.80
-10400A		410				4408.20
-10500A		500				4849.00
-21000A		1200				3746.90
-22000A		2000				3967.40
-23000A	160	3200	0.01	N/A	3.5	4187.80
-24000A		4100				4408.20
-25000A		5000				4849.00

Workbenches

- The standard work bench can add on square hanging plate or blinds hanging plate, lighting, power and other accessories
- Square hole hanging plate match with special square hook to effectively manage the tools use at work station
- Venetian hanging plate match with back hanging parts box to facilitate the storage of spare parts and other items
- Configure some of the modular components on the table to meet the requirements of various work sites, make it a test table, locksmith tables and other professional work desk
- **All desktops in this catalog are 50mm thick heavy duty desktops**
- **Can be customized according to customer requirements**

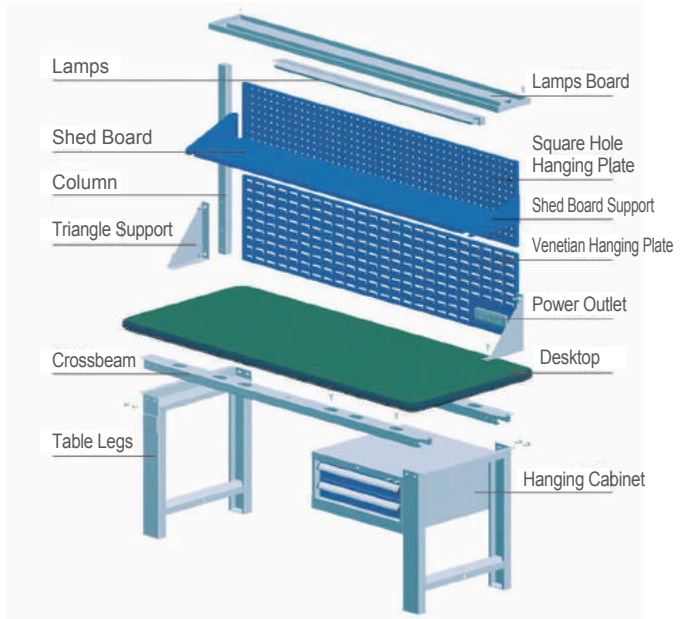

Optional accessories on the table

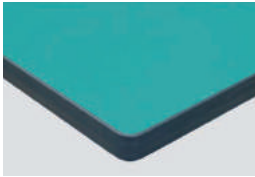

Heavy duty composite desktop

- 1, 2mm thick polymer materials surface, resistance to acid, abrasion and oil
- 2, Adopt high-pressure fiberboard desktop, more impact resistance
- 3, Special arc corner design, anti-impact



Beech block connection desktop

- 1, Made by beech block connection
- 2, High strength, suitable for machining
- 3, Impact resistance, can install accessories such as vices

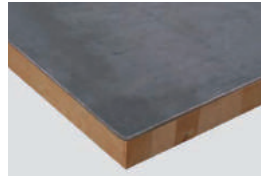

Iron plate composite desktop

- 1, Surface made of 6mm or 8mm thick steel plate, wooden base
- 2, Good strength, impact resistance, wear resistance, durability, long lifespan
- 3, Surface colour can be customized and spray colour according to customer requirements
- 4, Suitable for factory fitter jobs

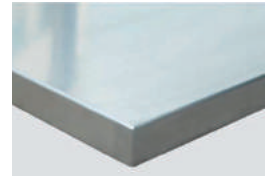

Stainless steel cladding desktop

- 1, Matte stainless steel clad, smooth, safe
- 2, Good strength, beautiful, durable
- 3, Resistance to acid and alkali
- 4, Suitable for dust and corrosion resistance working environment



Oak multi-layer work desktop

- 1, The surface made of oak veneer, the inner layer made of solid multi-layer board
- 2, The work desk is smooth, small deformation
- 3, Economic and practical



Fireproof board desktop

- 1, Beautiful, wear-resistant, fireproof
- 2, High-strength edging, solid, durable, not easily damaged, not easy to fall off



Dome light and slide bracket

- Mainly used to provide lighting for the work desk. At the same time can also provide various types of tools slide

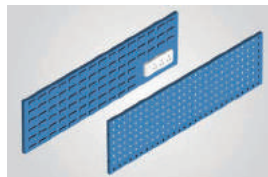

Square hole hanging plate

- Mainly used to install a variety of hooks and sheds



Air source connector

- Mainly used for pneumatic tools to provide air power interface



Vise

- Tablep can be equipped with vise, easy for repair work



Triangle support

- Triangle support to ensure that the column, lamp holder stability



Electric board

- Mainly used to install the socket panel

Heavy Duty Workbenches

- Adopt 2mm high quality cold rolled steel plate
- 50mm thick green composite board desktop
- Leg Sizes: 100 x 50mm
- Overall weight: 100kg, can directly install bench vise
- Can be customized according to customer requirements

Standard Type



Order Code	Size	Desktop	Price
TMWS30	W x D x H(mm)		RM
-11501A	1500 x 750 x 800	Composite Desktop	2523.60
-11801A	1800 x 750 x 800	Composite Desktop	2844.20
-12101A	2100 x 750 x 800	Composite Desktop	2839.60
-21501A	1500 x 750 x 800	Wooden Desktop	3892.60
-21801A	1800 x 750 x 800	Wooden Desktop	4459.60
-22101A	2100 x 750 x 800	Wooden Desktop	5026.60
-31501A	1500 x 750 x 800	Iron Plate Desktop	3510.80
-31801A	1800 x 750 x 800	Iron Plate Desktop	4019.90
-32101A	2100 x 750 x 800	Iron Plate Desktop	4517.50
-41501A	1500 x 750 x 800	Stainless Steel Desktop	3892.60
-41801A	1800 x 750 x 800	Stainless Steel Desktop	4459.60
-42101A	2100 x 750 x 800	Stainless Steel Desktop	5026.60

3-Drawer Type



Order Code	Size	Drawer Size	Desktop	Price
TMWS30	W x D x H(mm)	W x H(mm)		RM
-11501B	1500 x 750 x 800	350 x 125	Composite Desktop	4031.50
-11801B	1800 x 750 x 800	350 x 125	Composite Desktop	6107.50
-21501B	1500 x 750 x 800	350 x 125	Wooden Desktop	5605.20
-21801B	1800 x 750 x 800	350 x 125	Wooden Desktop	6322.60
-31501B	1500 x 750 x 800	350 x 125	Iron Plate Desktop	5223.30
-31801B	1800 x 750 x 800	350 x 125	Iron Plate Desktop	5882.90
-41501B	1500 x 750 x 800	350 x 125	Stainless Steel Desktop	5605.20
-41801B	1800 x 750 x 800	350 x 125	Stainless Steel Desktop	6322.60

Heavy Duty Cantilever Workbenches - Single Cabinet

- Can be customized according to customer requirements

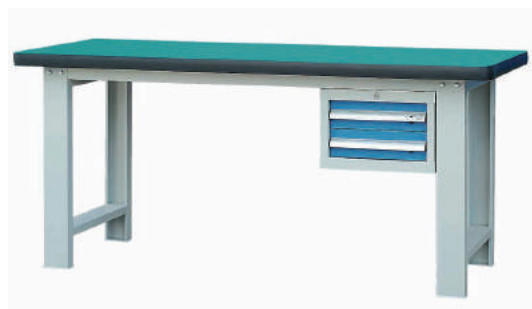

Type A

Order Code	Size	Drawer	Hanging Cabinet Size	Desktop	Price
TMWS30	W x D x H(mm)	Configuration	W x D (mm)		RM
-11502A	1500 x 750 x 800	2 x 100	411 x 572	Composite Desktop	3383.50
-11802A	1800 x 750 x 800	2 x 100	564 x 572	Composite Desktop	3915.80
-12102A	2100 x 750 x 800	2 x 100	564 x 572	Composite Desktop	4181.90
-21502A	1500 x 750 x 800	2 x 100	411 x 572	Wooden Desktop	4957.20
-21802A	1800 x 750 x 800	2 x 100	564 x 572	Wooden Desktop	5801.90
-22102A	2100 x 750 x 800	2 x 100	564 x 572	Wooden Desktop	6368.90
-31502A	1500 x 750 x 800	2 x 100	411 x 572	Iron Plate Desktop	4575.30
-31802A	1800 x 750 x 800	2 x 100	564 x 572	Iron Plate Desktop	5362.20
-32102A	2100 x 750 x 800	2 x 100	564 x 572	Iron Plate Desktop	5859.80
-41502A	1500 x 750 x 800	2 x 100	411 x 572	Stainless Steel Desktop	4957.20
-41802A	1800 x 750 x 800	2 x 100	564 x 572	Stainless Steel Desktop	5801.90
-42102A	2100 x 750 x 800	2 x 100	564 x 572	Stainless Steel Desktop	6368.90



Type B

Order Code	Size	Drawer	Hanging Cabinet Size	Desktop	Price
TMWS30	W x D x H(mm)	Configuration	W x D (mm)		RM
-11502B	1500 x 750 x 800	3 x 100	411 x 572	Composite Desktop	4712.30
-11802B	1800 x 750 x 800	3 x 100	564 x 572	Composite Desktop	4320.80
-12102B	2100 x 750 x 800	3 x 100	564 x 572	Composite Desktop	4586.90
-21502B	1500 x 750 x 800	3 x 100	411 x 572	Wooden Desktop	5281.20
-21802B	1800 x 750 x 800	3 x 100	564 x 572	Wooden Desktop	6206.90
-22102B	2100 x 750 x 800	3 x 100	564 x 572	Wooden Desktop	6773.90
-31502B	1500 x 750 x 800	3 x 100	411 x 572	Iron Plate Desktop	4899.30
-31802B	1800 x 750 x 800	3 x 100	564 x 572	Iron Plate Desktop	5767.20
-32102B	2100 x 750 x 800	3 x 100	564 x 572	Iron Plate Desktop	6264.80
-41502B	1500 x 750 x 800	3 x 100	411 x 572	Stainless Steel Desktop	5281.20
-41802B	1800 x 750 x 800	3 x 100	564 x 572	Stainless Steel Desktop	6206.90
-42102B	2100 x 750 x 800	3 x 100	564 x 572	Stainless Steel Desktop	6773.90

Heavy Duty Cantilever Workbenches - Double Cabinets

- Can be customized according to customer requirements



Type C					
Order Code	Size	Drawer	Hanging Cabinet Size	Desktop	Price
TMWS30	W x D x H(mm)	Configuration	W x D(mm)		RM
-11502C	1500 x 750 x 800	2 x 100	411 x 572	Composite Desktop	4448.10
-11802C	1800 x 750 x 800	2 x 100	564 x 572	Composite Desktop	5258.10
-12102C	2100 x 750 x 800	2 x 100	564 x 572	Composite Desktop	5524.20
-21502C	1500 x 750 x 800	2 x 100	411 x 572	Wooden Desktop	6021.80
-21802C	1800 x 750 x 800	2 x 100	564 x 572	Wooden Desktop	7144.20
-22102C	2100 x 750 x 800	2 x 100	564 x 572	Wooden Desktop	7711.20
-31502C	1500 x 750 x 800	2 x 100	411 x 572	Iron Plate Desktop	5639.90
-31802C	1800 x 750 x 800	2 x 100	564 x 572	Iron Plate Desktop	6704.50
-32102C	2100 x 750 x 800	2 x 100	564 x 572	Iron Plate Desktop	7202.10
-41502C	1500 x 750 x 800	2 x 100	411 x 572	Stainless Steel Desktop	6021.80
-41802C	1800 x 750 x 800	2 x 100	564 x 572	Stainless Steel Desktop	7144.20
-42102C	2100 x 750 x 800	2 x 100	564 x 572	Stainless Steel Desktop	7711.20



Type D					
Order Code	Size	Drawer	Hanging Cabinet Size	Desktop	Price
TMWS30	W x D x H(mm)	Configuration	W x D(mm)		RM
-11502D	1500 x 750 x 800	3 x 100	411 x 572	Composite Desktop	5975.50
-11802D	1800 x 750 x 800	3 x 100	564 x 572	Composite Desktop	6739.20
-12102D	2100 x 750 x 800	3 x 100	564 x 572	Composite Desktop	7005.30
-21502D	1500 x 750 x 800	3 x 100	411 x 572	Wooden Desktop	7549.20
-21802D	1800 x 750 x 800	3 x 100	564 x 572	Wooden Desktop	8625.30
-22102D	2100 x 750 x 800	3 x 100	564 x 572	Wooden Desktop	9192.30
-31502D	1500 x 750 x 800	3 x 100	411 x 572	Iron Plate Desktop	7167.30
-31802D	1800 x 750 x 800	3 x 100	564 x 572	Iron Plate Desktop	8185.60
-32102D	2100 x 750 x 800	3 x 100	564 x 572	Iron Plate Desktop	8683.20
-41502D	1500 x 750 x 800	3 x 100	411 x 572	Stainless Steel Desktop	7549.20
-41802D	1800 x 750 x 800	3 x 100	564 x 572	Stainless Steel Desktop	8625.30
-42102D	2100 x 750 x 800	3 x 100	564 x 572	Stainless Steel Desktop	9192.30

Heavy Duty Pedestal Workbenches

- Can be customized according to customer requirements



- Drawer Configuration(mm): 2 x 100, 1 x 150, 1 x 250

Type A					
Order Code	Size	Side Cabinet	Desktop	Price	
TMWS30	W x D x H(mm)	Size W x D(mm)		RM	
-11503A	1500 x 750 x 800	411 x 572 x 700	Composite Desktop	4031.50	
-11803A	1800 x 750 x 800	564 x 572 x 700	Composite Desktop	6168.10	
-12103A	2100 x 750 x 800	564 x 572 x 700	Composite Desktop	5061.30	
-21503A	1500 x 750 x 800	411 x 572 x 700	Wooden Desktop	5605.20	
-21803A	1800 x 750 x 800	564 x 572 x 700	Wooden Desktop	6681.30	
-22103A	2100 x 750 x 800	564 x 572 x 700	Wooden Desktop	7248.30	
-31503A	1500 x 750 x 800	411 x 572 x 700	Iron Plate Desktop	5223.30	
-31803A	1800 x 750 x 800	564 x 572 x 700	Iron Plate Desktop	6241.60	
-32103A	2100 x 750 x 800	564 x 572 x 700	Iron Plate Desktop	6739.20	
-41503A	1500 x 750 x 800	411 x 572 x 700	Stainless Steel Desktop	5605.20	
-41803A	1800 x 750 x 800	564 x 572 x 700	Stainless Steel Desktop	6681.30	
-42103A	2100 x 750 x 800	564 x 572 x 700	Stainless Steel Desktop	7248.30	



- Drawer Configuration(mm): 3 x 100, 2 x 150

Type B					
Order Code	Size	Side Cabinet	Desktop	Price	
TMWS30	W x D x H(mm)	Size W x D(mm)		RM	
-11503B	1500 x 750 x 800	411 x 572 x 700	Composite Desktop	4858.60	
-11803B	1800 x 750 x 800	564 x 572 x 700	Composite Desktop	6585.00	
-12103B	2100 x 750 x 800	564 x 572 x 700	Composite Desktop	6649.80	
-21503B	1500 x 750 x 800	411 x 572 x 700	Wooden Desktop	5859.80	
-21803B	1800 x 750 x 800	564 x 572 x 700	Wooden Desktop	7005.30	
-22103B	2100 x 750 x 800	564 x 572 x 700	Wooden Desktop	7572.30	
-31503B	1500 x 750 x 800	411 x 572 x 700	Iron Plate Desktop	5477.90	
-31803B	1800 x 750 x 800	564 x 572 x 700	Iron Plate Desktop	6565.60	
-32103B	2100 x 750 x 800	564 x 572 x 700	Iron Plate Desktop	7063.20	
-41503B	1500 x 750 x 800	411 x 572 x 700	Stainless Steel Desktop	5859.80	
-41803B	1800 x 750 x 800	564 x 572 x 700	Stainless Steel Desktop	7005.30	
-42103B	2100 x 750 x 800	564 x 572 x 700	Stainless Steel Desktop	7572.30	

Cantilever Combination Workbenches

- 50mm Composite Desktop
- Square hole hanging plate height 460mm
- Adjustable Shelves
- Standard lighthouse, power outlet
- Drawer configuration (mm): 2 x 100
- Can be customized according to customer requirements



Order Code	Size W x D x H(mm)	Hanging Cabinet Size W x D x H(mm)	Price RM
TMWS30			
-51502C	1500 x 750 x (800+1000)	411 x 572 x 300	4633.20
-51802C	1800 x 750 x (800+1000)	411 x 572 x 300	5026.60

Pedestal Combination Workbenches

- 50mm Composite Desktop
- Square hole hanging plate height 460mm
- Blinds hanging plate height 460mm
- Standard lighthouse, power outlet
- Drawer configuration (mm): 2 x 100, 1 x 150, 1 x 250
- Can be customized according to customer requirements



Order Code	Size W x D x H(mm)	Side Cabinet Size W x D x H(mm)	Price RM
TMWS30			
-51504D	1500 x 750 x (800+1000)	564 x 572 x 700	6369.80
-51804D	1800 x 750 x (800+1000)	564 x 572 x 700	7157.80

Tool Storage Cupboards

- Can be customized according to customer requirements



Order Code	Size W x D x H(mm)	Drawer Configuration	Adjustable Shelves	Price RM
TMWS31				
-10300A	1023 x 600 x 1800	3 x 100	3	6153.00



Order Code	Size W x D x H(mm)	Drawer Configuration	Adjustable Shelves	Square hole hanging board	Price RM
TMWS31					
-10301A	1023 x 600 x 1800	3 x 100	1	1	6015.30

Tool Storage Cupboards

- Can be customized according to customer requirements



Order Code	Size W x D x H(mm)	Drawer Configuration	Adjustable Shelves	Price RM
TMWS31				
-10900A	1023 x 600 x 1800	9 x 100	2	7460.80



Order Code	Size W x D x H(mm)	Drawer Configuration	Adjustable Shelves	Blinds Hanging Board	Price RM
TMWS31					
-11301C	1023 x 600 x 1800	3 x 100	7	2	6865.70



Order Code	Size W x D x H(mm)	Adjustable Shelves	Square hole hanging board	Price RM
TMWS31				
-20020B	1023 x 400 x 1800	2	1	3719.40
-20021B	1023 x 600 x 1800	2	1	4224.50



Order Code	Size W x D x H(mm)	Adjustable Shelves	Square hole hanging board	Price RM
TMWS31				
-20040B	1023 x 400 x 1800	4	1	4278.80
-20041B	1023 x 600 x 1800	4	1	4905.00



Order Code	Size W x D x H(mm)	Adjustable Shelves	Square hole hanging board	Price RM
TMWS31				
-21010B	1023 x 400 x 1800	1	4	4591.90
-21011B	1023 x 600 x 1800	1	4	5005.10



Order Code	Size W x D x H(mm)	Adjustable Shelves	Square hole hanging board	Blinds Hanging Board	Price RM
TMWS31					
-21020B	1023 x 400 x 1800	2	1	2	4882.00
-21021B	1023 x 600 x 1800	2	1	2	4775.50

Parts Storage Cabinets

- Drawer non-slip design can effectively protect the parts in the drawer
- Flexible space, drawer with movable partition, can adjust internal space for classification function
- **Can be customized according to customer requirements**



- Material box Inner/Outer Sizes W x D x H (mm): 95 x 193 x 42 / 101 x 220 x 47

- Material box Inner/Outer Sizes W x D x H (mm): 111 x 215 x 71 / 117 x 242 x 78

Order Code	Size	No. of Drawers	Price
TMWS34	W x D x H(mm)		RM
-10030A	640 x 325 x 928	30	1878.40

Order Code	Size	No. of Drawers	Price
TMWS34	W x D x H(mm)		RM
-10075A	626 x 267 x 935	75	2499.40

Order Code	Size	No. of Drawers	Price
TMWS34	W x D x H(mm)		RM
-11040A	640 x 325 x 928	40	2923.90

CNC Tool Storage Cupboards

- There are other types of storage cabinet to choose from
- **Can be customized according to customer requirements**



Order Code	Size	Tool Type	No. of Knife To Store	Price
TMWS35	W x D x H(mm)			RM
-13036A	738 x 526 x 1800	BT30	36	4854.90
-14030A	738 x 526 x 1800	BT40	30	4788.20
-15024A	738 x 526 x 1800	BT50	24	4788.20
-16330B	738 x 526 x 1800	HSK63	30	4899.50
-18024B	738 x 526 x 1800	HSK80	24	5344.90
-10024B	738 x 526 x 1800	HSK100	24	5344.90

CNC Tool Storage Trolleys

- There are other types of storage cabinet to choose from
- **Can be customized according to customer requirements**



Order Code	Size	Tool Type	No. of Knife To Store	Price
TMWS35	W x D x H(mm)			RM
-23040A	700 x 530 x 1300	BT30	40	2424.50
-24030A	700 x 530 x 1300	BT40	30	2303.30
-25020A	700 x 530 x 1300	BT50	20	2644.90
-26330A	700 x 530 x 1300	BT63	30	2521.50
-28025A	700 x 530 x 1300	BT80	25	2860.90
-20020A	700 x 530 x 1300	BT100	20	2561.10

TEMO[®] Professional Heavy Duty
EXCELLENT Twin-Door Cabinet Series

- Overall loading capacity - 600kg
- Top plate loading capacity - 80kg
- Shelves plate loading capacity - 100kg
- Drawers capacity - 50kg
- Optional materials work surfaces can be selected, composite, wooden, etc.
- Cabinet come with drawers, ensures safety and maximum stability.
- All accessories are optional.
- **Can be customized according to customer requirements.**

Twin-Door 3-Drawer Cabinet



Order Code TMWS50	Model	Size (mm)	Shelves (mm)	Price RM
-12053A	No.3	1023 x 555 x 1000(h)	500(d) x 1	4498.50

Twin-Door Double-Shelf Cabinet



Order Code TMWS50	Model	Size (mm)	Shelves (mm)	Price RM
-12051A	No.1	1023 x 555 x 1000(h)	500(d) x 2	2556.70

Twin-Door 4-Drawer Cabinet



Order Code TMWS50	Model	Size (mm)	Shelves (mm)	Price RM
-12054A	No.4	1023 x 555 x 1000(h)	500(d) x 1	4123.80

Twin-Door Double-Drawer Cabinet



Order Code TMWS50	Model	Size (mm)	Shelves (mm)	Price RM
-12052A	No.2	1023 x 555 x 1000(h)	500(d) x 2	3808.70

Extended Double-Drawer Cabinet - Twin-Door



Order Code TMWS50	Model	Size (mm)	Shelves (mm)	Price RM
-12055A	No.5	1023 x 555 x 1000(h)	500(d) x 1	3802.00

TEMO® Professional Heavy Duty Cupboard Series

EXCELLENT

- Overall loading capacity - 800kg
- Shelves plate loading capacity - 100kg
- Drawers capacity - 50kg
- Cabinet come with drawers, ensures safety and maximum stability.
- All accessories are optional.
- **Can be customized according to customer requirements.**

4-Shelf Cupboard



Order Code	Model	Size (mm)	Shelves (mm)	Price RM
-13001B	No.1	1023 x 400 x 2000(h)	345(d) x 4	3872.60

6-Shelf Cupboard



Order Code	Model	Size (mm)	Shelves (mm)	Price RM
-13002B	No.3	1023 x 400 x 2000(h)	345(d) x 6	4335.40

4-Shelf Visible Cupboard

- For greater transparency in the cabinets, 3mm clear polycarbonate plate is used for window doors.



Order Code	Model	Size (mm)	Shelves (mm)	Price RM
-13023B	No.2	1023 x 400 x 2000(h)	345(d) x 4	4864.40

Cupboard with Full Perforated Panels and Single Shelf

- Doors panel equipped with louver hanging plate for hanging bins. Load capacity = 40kg
- Shelf load capacity = 25kg

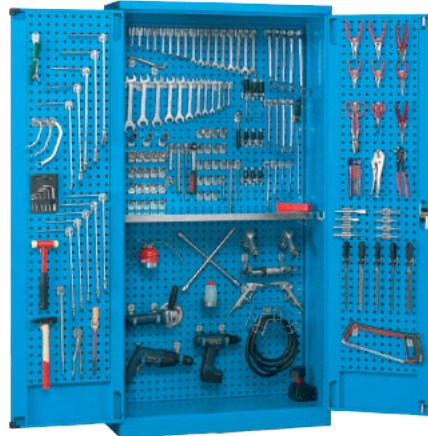

Order Code	Model	Size (mm)	Shelves (mm)	Price RM
-13030B	No.4	1023 x 400 x 2000(h)	250(d) x 1	5117.90

Cupboard with Full Perforated Panels and 4 Shelves

- Doors panel equipped with louver hanging plate for hanging bins. Load capacity = 40kg
- Shelf load capacity = 50kg



Order Code	Model	Size (mm)	Shelves (mm)	Price RM
TMWS50				
-14030B	No.5	1023 x 555 x 2000(h)	345(d) x 4	5532.20

3 Middle Drawers

- Shelf load capacity = 50kg



Order Code	Model	Size (mm)	Shelves (mm)	Price RM
TMWS50				
-14002B	No.6	1023 x 555 x 2000(h)	500(d) x 4	5995.10

3 Lower Drawer Cupboards with Perforated Panels

- Doors panel equipped with louver hanging plate for hanging bins. Load capacity = 40kg
- 345mm(d) Shelf load capacity = 50kg
- 500mm(d) Shelf load capacity = 100kg
- Bins excluded



Order Code	Model	Size (mm)	Shelves Configuration (mm)	Bins Quantity	Price RM
TMWS50					
-14035B	No.7	1023 x 555 x 2000(h)	250(d) x 4 345(d) x 3 500(d) x 1	Nothing	7802.50
-14036B	No.8	1023 x 555 x 2000(h)	250(d) x 4 345(d) x 3 500(d) x 1	40 x No.1 44 x No.2 16 x 3A2	11108.60

TEMO[®] Professional Series of Heavy Duty Storage Cabinets with **EXCELLENT Sliding Doors**

- Cabinets height at 1000mm/1200/2000mm.
- Smooth floor ensures the reliability and stability.
- All accessories are optional.
- **Can be customized according to customer requirements.**

Single-Shelf Cabinets with Sliding Doors

- Cabinets load capacity = 600kg
- Shelf load capacity= 100kg



Order Code	Model	Size (mm)	Shelves (mm)	Price RM
TMWS51				
-31000A	No.1	1023 x 450 x 1000(h)	370(d) x 1	2878.50
-61000A	No.2	1500 x 600 x 1000(h)	500(d) x 1	3885.80

Double-Shelf Cabinet with Sliding Doors

- Cabinets load capacity = 600kg
- Shelf load capacity= 100kg



Order Code	Model	Size (mm)	Shelves (mm)	Price RM
TMWS51				
-32000A	No.3	1023 x 450 x 1200(h)	370(d) x 2	3297.30

4-Shelf Cabinets with Sliding Doors

- Cabinets load capacity = 800kg
- Shelf load capacity= 100kg

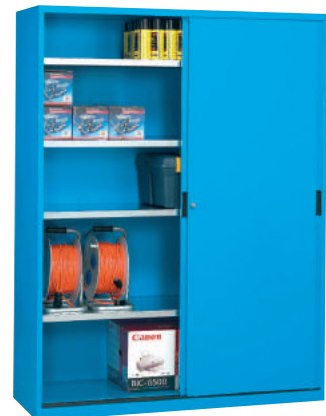
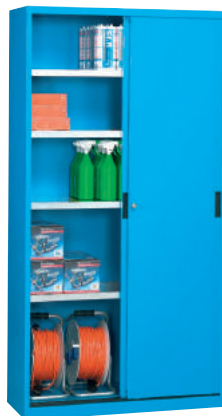

Order Code	Model	Size (mm)	Shelves (mm)	Price RM
TMWS51				
-33000A	No.4	1023 x 450 x 2000(h)	370(d) x 4	4421.40
-43001A	No.5	1023 x 600 x 2000(h)	500(d) x 4	4923.90
-63000A	No.6	1500 x 600 x 2000(h)	500(d) x 4	6424.90

TEMO[®] **EXCELLENT** Professional Series of Heavy Duty Parts Storage Cabinets

- Smooth floor ensures the reliability and stability.
- Parts bins included.
- Can be customized according to customer requirements.

6-Shelf Parts Storage Cabinet

- Cabinets load capacity = 450kg
- Shelf load capacity= 50kg
- Standard parts bins included :
Blue : 24 x Type 1 bins.
Grey : 12 x Type 2 bins.



Order Code	Model	Size (mm)	Shelves (mm)	Price RM
TMWS52				
-20405C	No.1	700 x 270 x 1000(h)	235(d) x 6	2093.90

6-Shelf Parts Storage Cabinet with Doors

- Cabinets load capacity = 450kg
- Shelf load capacity= 50kg
- Standard parts bins included :
Blue : 24 x Type 1 bins.
Grey : 12 x Type 2 bins.



Order Code	Model	Size (mm)	Shelves (mm)	Price RM
TMWS52				
-10405C	No.2	700 x 270 x 1000(h)	235(d) x 6	2689.00

12-Shelf Parts Storage Cabinet

- Cabinets load capacity = 500kg
- Shelf load capacity= 50kg
- Standard parts bins included :
Blue : 42 x Type 1 bins.
Grey : 24 x Type 2 bins.

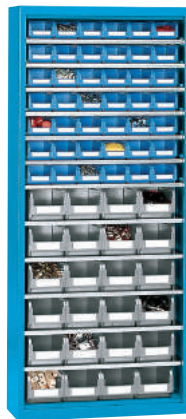

Order Code	Model	Size (mm)	Shelves (mm)	Price RM
TMWS52				
-20665C	No.3	700 x 270 x 1750(h)	235(d) x 12	3482.50

12-Shelf Parts Storage Cabinet with Doors

- Cabinets load capacity = 500kg
- Shelf load capacity= 50kg
- Standard parts bins included :
Blue : 42 x Type 1 bins.
Grey : 24 x Type 2 bins.



Order Code	Model	Size (mm)	Shelves (mm)	Price RM
TMWS52				
-10665C	No.4	700 x 270 x 1750(h)	235(d) x 12	4253.90

15-Shelf Parts Storage Cabinet

- Cabinets load capacity = 500kg
- Shelf load capacity= 50kg
- Standard parts bins included :
Blue : 54 x Type 1 bins.
Grey : 24 x Type 2 bins.

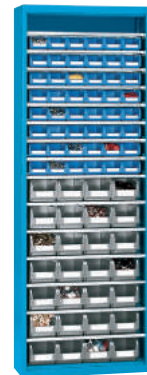

Order Code	Model	Size (mm)	Shelves (mm)	Price RM
TMWS52				
-20805C	No.5	700 x 270 x 2000(h)	235(d) x 15	4077.60

15-Shelf Parts Storage Cabinet with Doors

- Cabinets load capacity = 500kg
- Shelf load capacity= 50kg
- Standard parts bins included :
Blue : 54 x Type 1 bins.
Grey : 24 x Type 2 bins.

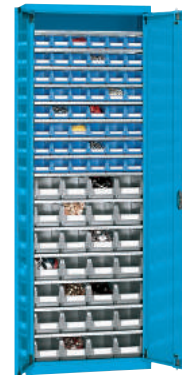

Order Code	Model	Size (mm)	Shelves (mm)	Price RM
TMWS52				
-10805C	No.6	700 x 270 x 2000(h)	235(d) x 15	4959.20

Storage Parts Bins size

Size	Colour	External Dimensions (mm)	Internal Dimensions (mm)
No.1	Blue	160(D1)/140(D2)* 95(W)* 75(H)	134 * 88 * 65mm
No.2	Grey	230(D1)/200(D2)* 140(W) *130(H)	130 * 124 * 111mm
No.3	Grey	350(D1/300(D2) * 200(W) * 200(H)	278 * 180 * 187mm

TEMO[®] Professional Series of Heavy Duty Tool Storage System
EXCELLENT

- Tools Holder Details :



Tool Type	Order Code TMWS55	Type 1# No. of knife To Store	Type 2# No. of knife To Store	Type 3# No. of knife To Store	Price RM
ISO30	95100D	7	24	36	24.20
ISO40	95300D	5	18	36	24.20
ISO50	95500D	4	12	24	26.70
VDI30	95600D	7	24	36	145.50
VDI40	95700D	5	18	30	157.60
VDI50	95800D	5	18	30	164.90
VDI60	95900D	5	15	24	181.80
MT2	97200D	7	24	36	60.60
MT3	97300D	7	24	36	60.60
MT4	97400D	7	24	36	60.60
MT5	97500D	5	18	30	60.60
CAPTO C3	92700D	7	24	36	60.60
CAPTO C4	92750D	5	18	30	60.60
CAPTO C5	92800D	5	18	30	60.60
CAPTO C6	92850D	5	18	30	60.60
CAPTO C8	92900D	4	12	24	60.60
HSK A32-B40	92100D	7	24	36	60.60
HSK A40-B50	92200D	7	24	36	60.60
HSK A50-B63	92300D	5	18	30	60.60
HSK A63-B80	92400D	5	18	30	24.20
HSK A80-B100	92500D	4	12	24	60.60
HSK A100-B125	92600D	4	12	24	24.20

- Can be customized according to customer requirements.

Tool Storage Trolley with 5 Tool Carriers

- Load capacity : 500kg
- Equipped with side angle tools holder with antislip rubber mat.
- Equipped with two directed and two-brake 100mm (4") rubber casters.
- Tools are optional
- Can be allocated according to customer requirements.



Order Code TMWS55	Model	Size (mm)	Tools Cart (with tools holder) Type 1#	Price RM
-10010A	No.1	1064 x 512 x 890(h)	5 Sets	2589.80

Tool Storage Trolley with 7 Tool Carriers

- Load capacity : 500kg
- Equipped with side angle tools holder with antislip rubber mat.
- Equipped with two directed and two-brake 100mm (4") rubber casters.
- Tools are optional
- Can be allocated according to customer requirements.



Order Code TMWS55	Model	Size (mm)	Tools Cart (with tools holder) Type 1#	Price RM
-10015A	No.2	1064 x 512 x 890(h)	7 Sets	2876.30

Combination Tool Storage Trolley with 8 Tool Carriers

- Load capacity : 350kg
- Equipped with 3 adjustable shelf plate enables effectively use space , with antislip rubber mat.
- Equipped with 1 drawer can be pulled out for easy storage.
- Equipped with two directed and two-brake 100mm (4") nylon casters.
- Tools are optional
- Can be allocated according to customer requirements.



Order Code TMWS55	Model	Size (mm)	Tools Cart (with tools holder) Type 1#	Price RM
-60006A	No.3	1073 x 685 x 890(h)	8 Sets	4760.80

Door Type Tool Storage Cabinet with 4 Tool Carriers

- Load capacity : 800kg
- Load capacity for each level : 150kg
- Tools are optional
- Can be allocated according to customer requirements.



Order Code TMWS55	Model	Size (mm)	Tools Cart (with tools holder) Type 3#	Price RM
-14001B	No.4	1023 x 555 x 2000(h)	4 Sets	4915.10

Visible Tool Storage Cabinet with 4 Tool Carriers

- Load capacity : 800kg
- Load capacity for each level : 150kg
- Tools are optional
- Can be allocated according to customer requirements.



Order Code TMWS55	Model	Size (mm)	Tools Cart (with tools holder) Type 3#	Price RM
-14020B	No.5	1023 x 555 x 2000(h)	4 Sets	5818.80

TEMO[®] EXCELLENT Professional Series of Heavy Duty Double-Section Working Benches

- 50mm Beech wood Desktop.
- Can be customized according to customer requirements.

Standard Type

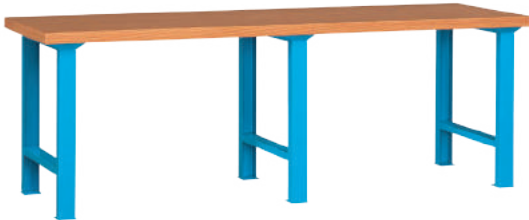

Order Code	Model	Size (mm)	Capacity (kg)	Desktop	Desktop Structure	Price RM
-48401L	No.1	2500 x 750 x 800(h)	1000	Beech wood	1 pc	6715.80
-48407L	No.2	2500 x 750 x 800(h)	1000	MDF Board	1 pc	4428.00
-58401L	No.3	2500 x 850 x 800(h)	1000	Beech wood	1 pc	7072.90
-58407L	No.4	2500 x 850 x 800(h)	1000	MDF Board	1 pc	4582.30
-49801L	No.5	3000 x 750 x 800(h)	800	Beech wood	1 pc	7965.60
-49807L	No.6	3000 x 750 x 800(h)	800	MDF Board	2 x1500mm conjoint	5444.10
-58901L	No.7	3000 x 800 x 800(h)	800	Beech wood	1 pc	8362.30
-58907L	No.8	3000 x 800 x 800(h)	800	MDF Board	2 x1500mm conjoint	5594.00

Cantilever Type

- Drawer configuration : 1 x 50mm , 1 x 10mm, 1 x 150mm(h)
- Drawer can be pulled out up to 87% for easy storage.



Order Code	Model	Size (mm)	Capacity (kg)	Desktop	Desktop Structure	Price RM
-48404L	No.9	2500 x 750 x 800(h)	1000	Beech wood	1 pc	8994.90
-48409L	No.10	2500 x 750 x 800(h)	1000	MDF Board	1 pc	6707.00
-58404L	No.11	2500 x 800 x 800(h)	1000	Beech wood	1 pc	9351.90
-58409L	No.12	2500 x 800 x 800(h)	1000	MDF Board	1 pc	6861.30
-49804L	No.13	3000 x 750 x 800(h)	800	Beech wood	1 pc	10244.60
-49809L	No.14	3000 x 750 x 800(h)	800	MDF Board	2 x1500mm conjoint	7454.20
-58904L	No.15	3000 x 800 x 800(h)	800	Beech wood	1 pc	10641.30
-58909L	No.16	3000 x 800 x 800(h)	800	MDF Board	2 x1500mm conjoint	7604.10

Pedestal Type - Single Cabinet

- Drawer configuration : 1 x100mm , 1 x 150mm(h)
- Drawer can be pulled out up to 87% for easy storage.
- Cabinet height . 450mm



Order Code	Model	Size (mm)	Capacity (kg)	Desktop	Desktop Structure	Price RM
-49822L	No.17	3000 x 750 x 850(h)	800	Beech wood	1 pc	10442.90
-49827L	No.18	3000 x 750 x 850(h)	800	MDF Board	2 x1500mm conjoint	7701.10
-59822L	No.19	3000 x 800 x 850(h)	800	Beech wood	1 pc	10839.70
-59827L	No.20	3000 x 800 x 850(h)	800	MDF Board	2 x1500mm conjoint	7855.40

Pedestal Type - Twin Cabinets

- Left Drawer configuration : 1 x 50, 2 x100mm , 1 x 150mm, 1 x 200mm (h)
- Right Drawer configuration : 4 x 75, 1 x100mm , 1 x 200mm (h)
- Drawer can be pulled out up to 87% for easy storage.



Order Code	Model	Size (mm)	Capacity (kg)	Desktop	Desktop Structure	Price RM
-49816L	No.21	3000 x 750 x 850(h)	800	Beech wood	1 pc	14751.90
-49817L	No.22	3000 x 750 x 850(h)	800	MDF Board	2 x1500mm conjoint	12744.00
-59816L	No.23	3000 x 800 x 850(h)	800	Beech wood	1 pc	15148.70
-59817L	No.24	3000 x 800 x 850(h)	800	MDF Board	2 x1500mm conjoint	12893.90

Combination Type

- Left cabinet (Drawer)1 x100mm(h) (Storage Cabinet) 1 x 600mm (h)
- Equipped with adjustable cabinet shelve plate for height adjustments, can be pulled out for easy storage.
- Right Drawer configuration : 2 x 100, 2 x 200mm (h)
- Drawer can be pulled out up to 87% for easy storage.



Order Code	Model	Size (mm)	Capacity (kg)	Desktop	Desktop Structure	Price RM
-48428L	No.25	2400 x 750 x 800(h)	1000	Beech wood	1 pc	11370.90
-48427L	No.26	2400 x 750 x 800(h)	1000	MDF Board	1 pc	8642.20
-58428L	No.27	3000 x 800 x 800(h)	1000	Beech wood	1 pc	11701.50

TEMO® Professional Series of Heavy Duty Combination EXCELLENT Workstations

- 40mm Beech wood Desktop.
- 50mm Composite Desktop.
- Can be customized according to customer requirements.

Type A



Order Code TMWS57	Model	Size (mm)	Drawer Configuration (mm)	Door Configuration (mm)	Shelves late	Capacity (kg)	Desktop	Price RM
-22420A	A01	1500 x 750 x 865(h)	150(h) x 1	450(h) x 1	1	1000	Beech wood	6696.00
-22427A	A02	1500 x 750 x 865(h)	150(h) x 1	450(h) x 1	1	1000	MDF Board	5525.63

Type B



Order Code TMWS57	Model	Size (mm)	Drawer Configuration (mm)	Door Configuration (mm)	Capacity (kg)	Desktop	Price RM
-22420B	B01	1500 x 750 x 865(h)	150(h) x 1 75(h) x 2	450(h) x 2	1000	Beech wood	8042.69
-22427B	B02	1500 x 750 x 865(h)	150(h) x 1 75(h) x 2	450(h) x 2	1000	MDF Board	6872.33

Type C



Order Code TMWS57	Model	Size (mm)	Drawer Configuration (mm)	Capacity (kg)	Desktop	Price RM
-22420C	C01	1500 x 750 x 865(h)	100(h) x 2 200(h) x 2 300(h) x 2	1000	Beech wood	8556.24
-22427C	C02	1500 x 750 x 865(h)	100(h) x 2 200(h) x 2 300(h) x 2	1000	MDF Board	7385.88

Type D



Order Code TMWS57	Model	Size (mm)	Drawer Configuration (mm)	Door Configuration (mm)	Shelves late	Capacity (kg)	Desktop	Price RM
-22430D	D01	2000 x 750 x 865(h)	150(h) x 1	600(h) x 1 450(h) x 1	1	1000	Beech wood	9210.86
-22437D	D02	2000 x 750 x 865(h)	150(h) x 1	600(h) x 1 450(h) x 1	1	1000	MDF Board	7650.37

Type E



Order Code TMWS57	Model	Size (mm)	Drawer Configuration (mm)	Door Configuration (mm)	Shelves late	Capacity (kg)	Desktop	Price RM
-22430E	E01	2000 x 750 x 865(h)	75(h) x 4 100(h) x 1 200(h) x 1	600(h) x 2	2	1000	Beech wood	11137.22
-22437E	E02	2000 x 750 x 865(h)	75(h) x 4 100(h) x 1 200(h) x 1	600(h) x 2	2	1000	MDF Board	9576.73

Type F



Order Code TMWS57	Model	Size (mm)	Drawer Configuration (mm)	Door Configuration (mm)	Capacity (kg)	Desktop	Price RM
-22430F	F01	2000 x 750 x 865(h)	75(h) x 2 150(h) x 2	450(h) x 3	1000	Beech wood	11187.92
-22437F	F02	2000 x 750 x 865(h)	75(h) x 2 150(h) x 2	450(h) x 3	1000	MDF Board	9627.43

Type G



Order Code TMWS57	Model	Size (mm)	Drawer Configuration (mm)	Door Configuration (mm)	Shelves late	Capacity (kg)	Desktop	Price RM
-22440G	G01	2400 x 750 x 865(h)	100(h) x 2 200(h) x 2 300(h) x 2	600(h) x 2	2	2000	Beech wood	13960.65
-22447G	G02	2400 x 750 x 865(h)	100(h) x 2 200(h) x 2 300(h) x 2	600(h) x 2	2	2000	MDF Board	12226.04

Type H



Order Code TMWS57	Model	Size (mm)	Drawer Configuration (mm)	Door Configuration (mm)	Capacity (kg)	Desktop	Price RM
-22440H	H01	2400 x 750 x 865(h)	150(h) x 4	450(h) x 4	2000	Beech wood	14344.16
-22447H	H02	2400 x 750 x 865(h)	150(h) x 4	450(h) x 4	2000	MDF Board	12609.55

Type J



Order Code TMWS57	Model	Size (mm)	Drawer Configuration (mm)	Door Configuration (mm)	Shelves late	Capacity (kg)	Desktop	Price RM
-22450J	J01	3000 x 750 x 865(h)	100(h) x 1 200(h) x 1 300(h) x 1	600(h) x 2	4	2000	Beech wood	14701.22

Type K



Order Code TMWS57	Model	Size (mm)	Drawer Configuration (mm)	Door Configuration (mm)	Shelves late	Capacity (kg)	Desktop	Price RM
-22450K	K01	3000 x 750 x 865(h)	75(h) x 2 100(h) x 2 150(h) x 1 200(h) x 2	600(h) x 2 450(h) x 2	2	2000	Beech wood	17427.67



Professional Heavy Duty Mobile Workstations

- 30mm Beech wood Desktop. • Inter- locking
- Equipped with two directed and two-brake 100mm (4") rubber casters.
- Can be customized according to customer requirements.

Type A

- Desktop Load Capacity : 250kg



Order Code TMWS58	Model	Size (mm)	Drawer Configuration (mm)	Door Configuration (mm)	Shelves late	Capacity (kg)	Desktop	Price RM
-32001A	A11	860 x 600 x 877(h)	100(h) x 2 200(h) x 2	600(h) x 1	2 x (1 x adjustable) (1 x base plate)	70	Beech wood	6693.80
-32007A	A12	860 x 600 x 877(h)	100(h) x 2 200(h) x 2	600(h) x 1	2 x (1 x adjustable) (1 x base plate)	70	MDF Board	6369.80
-42001A	A13	995 x 600 x 910(h)	100(h) x 2 200(h) x 2	600(h) x 1	2 x (1 x adjustable) (1 x base plate)	70	Beech wood	6823.80
-42007A	A14	995 x 600 x 910(h)	100(h) x 2 200(h) x 2	600(h) x 1	2 x (1 x adjustable) (1 x base plate)	70	MDF Board	6107.50
-51001A	A15	1150 x 700 x 915(h)	100(h) x 2 200(h) x 2	600(h) x 1	2 x (1 x adjustable) (1 x base plate)	70	Beech wood	7154.50
-51007A	A16	1150 x 700 x 915(h)	100(h) x 2 200(h) x 2	600(h) x 1	2 x (1 x adjustable) (1 x base plate)	70	MDF Board	6413.90
-61001A	A17	1227 x 700 x 910(h)	100(h) x 2 200(h) x 2	600(h) x 1	2 x (1 x adjustable) (1 x base plate)	70	Beech wood	7670.20
-61007A	A18	1227 x 700 x 910(h)	100(h) x 2 200(h) x 2	600(h) x 1	2 x (1 x adjustable) (1 x base plate)	70	MDF Board	6929.60

Type B

- Desktop Load Capacity : 250kg



Order Code TMWS58	Model	Size (mm)	Drawer Configuration (mm)	Shelves late	Capacity (kg)	Desktop	Price RM
-32004B	B11	937 x 600 x 910(h)	100(h) x 2 200(h) x 2	2 x (1 x adjustable) (1 x base plate)	70	Beech wood	6341.10
-32007B	B12	937 x 600 x 910(h)	100(h) x 2 200(h) x 2	2 x (1 x adjustable) (1 x base plate)	70	MDF Board	5624.80
-42004B	B13	1072 x 600 x 910(h)	100(h) x 2 200(h) x 2	2 x (1 x adjustable) (1 x base plate)	70	Beech wood	6471.20
-42007B	B14	1072 x 600 x 910(h)	100(h) x 2 200(h) x 2	2 x (1 x adjustable) (1 x base plate)	70	MDF Board	5754.90
-51004B	B15	1227 x 700 x 915(h)	100(h) x 2 200(h) x 2	2 x (1 x adjustable) (1 x base plate)	70	Beech wood	6801.80
-51007B	B16	1227 x 700 x 915(h)	100(h) x 2 200(h) x 2	2 x (1 x adjustable) (1 x base plate)	70	MDF Board	6061.20

TEMO[®] Professional Series of Plastic Storage Bin Trolleys
INDUSTRIAL • Can be customized according to customer requirements

Type A - Single Side



Order Code TMWS60	Size (mm)	level	Bins Quantity	Bins Size	Colour	Load capacity (kg)	Price RM
-15619A	1425 x 525 x 1490(h)	5	20	No.3	Grey	500	7705.50
-15618A	1425 x 525 x 1490(h)	6	24	No.3	Grey	500	8384.30

Type B - Single Side



Order Code TMWS60	Size (mm)	level	Bins Quantity	Bins Size	Colour	Load capacity (kg)	Price RM
-20614B	1425 x 625 x 1590(h)	4	12	600 x 400 x 148	Grey	500	7026.60
-20616B	1425 x 625 x 1590(h)	3	9	600 x 400 x 280	Grey	500	6160.40

Type C - Double Sides

Size	Colour	External Dimensions (mm)	Internal Dimensions (mm)	Quantity
No.2	Grey	230(D1)/200(D2) x 140(W) x 130(H)	130 x 124 x 111	98

Order Code TMWS60	Size (mm)	level	Bins Quantity	Load capacity (kg)	Price RM
-04053C	1207 x 540 x 1530(h)	7	98	300	5699.80



TEMO[®] **INDUSTRIAL** Plastic Bin Trolleys
 • Can be customized according to customer requirements

Order Code TMWS60	Size L x W x H(mm)	level	Load capacity (kg)	Plastic Bin Size W x D x H(mm)	Price RM
-00031A	1300 x 650 x 1500	3	300	600 x 400 x 280	3640.40
-00041A	1300 x 650 x 1500	4	300	600 x 400 x 148	4276.80

TEMO® Professional Series of Plastic Storage Bin Trolleys**INDUSTRIAL** • Can be customized according to customer requirements**Type D - Double Sides**

Available Bins

Size	Colour	External Dimensions (mm)	Internal Dimensions (mm)	Quantity
No.1	Blue	160(D1)/140(D2) x 95(W) x 75(H)	138 x 88 x 65	200

Order Code	Size (mm)	level	Bins Quantity	Load capacity (kg)	Price RM
TMWS60					
-04051D	1207 x 540 x 1530(h)	10	200	300	5757.10

Type E - Double Sides

Available Bins

Size	Colour	External Dimensions (mm)	Internal Dimensions (mm)	Quantity
No.1	Blue	160(D1)/140(D2) x 95(W) x 75(H)	134 x 88 x 65	100
No.2	Grey	230(D1)/200(D2) x 140(W) x 130(H)	130 x 124 x 111	56

Order Code	Size (mm)	level	Bins Quantity	Load capacity (kg)	Price RM
TMWS60					
-04052E	1207 x 540 x 1530(h)	9	156	300	6017.10

Type F - Double Sides

Available Bins

Size	Colour	External Dimensions (mm)	Internal Dimensions (mm)	Quantity
No.1	Blue	160(D1)/140(D2) x 95(W) x 75(H)	134 x 88 x 65	36
No.2	Grey	230(D1)/200(D2) x 140(W) x 130(H)	130 x 124 x 111	16
No.3	Grey	350(D1/300(D2) x 200(W) x 200(H)	278 x 180 x 187	12

Order Code	Size (mm)	level	Bins Quantity	Load capacity (kg)	Price RM
TMWS60					
-02053F	805 x 655 x 1395(h)	7	64	300	4108.40

Type G - Double Sides

Available Bins

Size	Colour	External Dimensions (mm)	Internal Dimensions (mm)	Quantity
No.1	Blue	160(D1)/140(D2) x 95(W) x 75(H)	134 x 88 x 65	60
No.2	Grey	230(D1)/200(D2) x 140(W) x 130(H)	130 x 124 x 111	24

Storage Parts Bins size

Size	Colour	External Dimensions (mm)	Internal Dimensions (mm)
No.1	Blue	160(D1)/140(D2) x 95(W) x 75(H)	134 x 88 x 65
No.2	Grey	230(D1)/200(D2) x 140(W) x 130(H)	130 x 124 x 111
No.3	Grey	350(D1/300(D2) x 200(W) x 200(H)	278 x 180 x 187

Order Code	Size (mm)	level	Bins Quantity	Load capacity (kg)	Price RM
TMWS60					
-02052G	805 x 655 x 1395(h)	8	84	300	3733.70

Stainless Steel Trolleys

- Made of high quality stainless steel plate
- Can be customized according to customer requirements



Figure 1



Figure 2



Figure 3



Figure 4



Figure 5



Figure 6

Order Code	Size W x D x H (mm)	Load Capacity (kg)	Figure	Price RM
TMLG40				
-01600S	900 x 600 x 860	300	1	1322.60
-01605S	1200 x 600 x 860	500	1	1542.90
-02600S	900 x 600 x 900	500	2	2691.20
-02800S	1000 x 800 x 900	500	2	3056.30
-03600S	900 x 600 x 1200	500	3	3344.90
-03800S	1000 x 800 x 1200	500	3	3710.00
-04600S	900 x 600 x 900	500	4	4165.60
-04800S	1000 x 800 x 900	500	4	4485.40
-05600S	900 x 600 x 900	500	5	3511.90
-05800S	1000 x 800 x 900	500	5	3877.00
-06600S	900 x 600 x 1500	500	6	4728.80
-06800S	1000 x 800 x 1500	500	6	5215.50

Stainless Steel Working Benches

- Made of high quality stainless steel plate
- Can be customized according to customer requirements



Figure 1



Figure 2



Figure 3



Figure 4



Figure 5



Figure 6

Order Code	Size W x D x H (mm)	Figure	Price RM
TMWS40			
-11600S	1200 x 600 x 850	1	2458.70
-11601S	1500 x 600 x 850	2	2775.10
-11602S	1200 x 600 x 850	3	3359.10
-11603S	1800 x 600 x 850	4	3602.50
-11750S	1500 x 750 x 850	5	4819.30
-11751S	1500 x 750 x 850	6	6613.50

Compound Layers Anti-Fatigue Mats - Anti-Statics Type

- Manufactured from ESD Floor materials, Anti-Statics
- Middle layer is EDPM foam , bottom layer is conductive rubber.
- Diamond surface provides greater traction with extended wear and can be easily cleaned.
- Suitable for wet and slippery conditions.
- Anti fatigue standing mat gives support and comfort while you standing all day in kitchens, offices, garages, or laundry rooms.
- Relieve foot , knee , joint , and back pains by providing professional manufacturing techniques with supportive and high-density materials.
- **Can be customized according to customer requirements.**
- Manufactured with two yellow borders and ramped edges all round for additional safety.

- Colour : Black
- Thickness : 12mm



Order Code	Thickness (mm)	Size (L x W) (mm)	Type	Price RM
TMWS65				
-09612A	12	900 x 600	Black Diamond Tread with two yellow borders	160.40

Anti-Statics Bubble Stand Anti-Fatigue Mats

- Manufactured from 100% natural rubber , conform to ROHS standard.
- Suitable Environment : Oily , Slippery
- Anti Fatigue Mats provide supportive standing experience to alleviate foot discomfort caused by long time standing.
- Relieve foot , knee , joint , and back pains by providing professional manufacturing techniques with supportive and high-density materials.
- No need to worry about the creases and curled edges, it can get back into shape after few minutes after rolling.
- Manufactured accordance to ANSIESDS2020-2014 productions standard, Anti-Statics bubble surface.

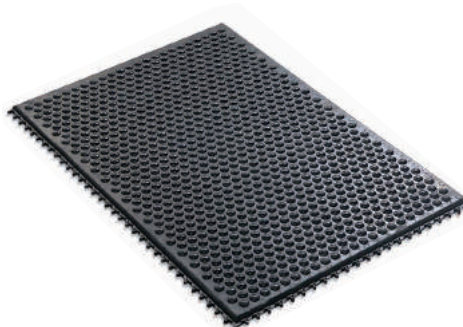

Order Code	Colour	Size (L x W x T) (mm)	Shape	Price RM
TMWS65				
-20950A	Black	910 x 610 x 17	Diamond	353.80
-20950B	Black	450 x 610 x 17	Diamond	179.20

Nitrile Anti-Fatigue Mats - Anti-Slip Type

- Nitrile Anti-Fatigue Mats
- Suitable Environment : Oily , Slippery
- Interlocks , Custom widths or unique configurations
- Anti fatigue standing mat gives support and comfort while you standing all day in kitchens, offices, garages, or laundry rooms.
- Relieve foot , knee , joint , and back pains by providing professional manufacturing techniques with supportive and high-density materials.
- **Can be customized according to customer requirements.**



Order Code	Colour	Size (L x W x T) (mm)	Model	Price RM
TMWS65				
-10472W	Black	914 x 914 x 12.5	Hole Type Interlocking	283.00



TEMO®

Hydraulic Equipment & Tools

www.temomalaysia.com

12 Ton Battery Powered Hydraulic Crimping Tools - Type C

- Ergonomic design, light weight, one-handed operation, forward & reverse easy control button
- High-low pressure two-stage piston pump drive design, fast crimping
- C-type forged alloy steel crimping head, long service lifespan
- With safety relief valve, automatic pressure relief after standard output, stable crimping quality
- Crimping head can be rotated 180°, suitable for crimping at different angles
- Power: 14.4VDC battery, quick charge for 60 minutes
- It can be used about 70-150 crimping times after fully charged and the battery can be recharged 1000 times
- With power capacity indicator
- Main accessories: 1 charger, 1 plastic storage box and 1 shoulder strap



Order Code	Opening (mm)	Crimping Range	Size(mm) L x H x W	Weight (kg)	Price RM
-12025C	25	Aluminum terminal Max300mm ² , Copper terminal Max 400mm ²	300 × 300 × 78	7	32963.40
-12030C	30	Aluminum terminal Max300mm ² , Copper terminal Max 400mm ²	350 × 300 × 78	7	33712.50
-12038C	38	Aluminum terminal Max300mm ² , Copper terminal Max 400mm ²	380 × 300 × 78	8	34336.80
-12042C	42	Aluminum terminal Max300mm ² , Copper terminal Max 400mm ²	418 × 300 × 78	8	35086.00

Spare Battery

Order Code	Specification	Price RM
TMHY70	14.4V Ni-MH	2772.00

12 Ton Battery Powered Hydraulic Crimping Tools

- Ergonomic design, light weight, one-handed operation, forward & reverse easy control
- With safety relief valve, stable crimping quality
- Crimping head can be rotated 180°, suitable for crimping at different angles
- Power: 14.4VDC battery, quick charge for 60 minutes
- It can be used about 70-150 crimping times after fully charged and the battery can be recharged 1000 times
- With power capacity indicator
- Main accessories: 1 charger, 1 plastic storage box



Spare Battery

Order Code	Specification	Price RM
TMHY70	14.4V Ni-MH	2772.00

Order Code	Type	Crimping Range (JIS mm ²) (DIN mm ²) (AWG/MCM)	Standard Crimping Dies(mm ²)	Size(mm) (L x H x W)	Weight (kg)	Figure	Price RM
-12185A	Pistol Rotary Type	14 - 150 16 - 185 6 / 350	Male Dies (3):16 - 25,35 - 70,70 - 185 Star Female Dies (5):16 - 25,35 - 70,95 - 120,150,185	350 × 240 × 70	6	1	29717.00
-12240A	Pistol Rotary Type	22 - 200 25 - 240 4 / 500	Male Dies (4):25,35 - 60,70 - 185,240 Star Female Dies (5):25 - 35,50 - 70,95 - 120,150 - 185,240	350 × 240 × 70	6	1	29966.70
-12400D	Pistol Pin Type	14 - 325 16 - 400 2 / 750	Male Dies (4):16,25 - 35,50 - 120,150 - 400 Female Dies (8):16 - 25,35 - 70,95 - 120,150,185,240,300,400	350 × 240 × 70	7	2	30715.90
-12401D	Pistol Pin Type	14 - 325 35 - 400 2 / 750	Hexagonal Dies (10):35,50,70,95,120,150,185,240,300,400	350 × 240 × 70	7	2	31340.20
-12402D	Pistol Pin Type	Use standard dies to crimp up to : 400mm ² , Use standard dies to crimp up to : 35 - 50,70 - 95mm ² , Use standard dies to crimp up to : 120 - 150,185 - 240mm ² ,		300 × 300 × 78	7	3	31340.20
-12630D	Pistol Pin Type	38 - 630 35 - 630 1200	Hexagonal Dies (10):35,50,70,95,120,150,185,240,300,400,500,630	420 × 300 × 78	7	4	36209.80

6 Ton Battery Powered Hydraulic Crimping Tools

- High-low pressure two-stage piston pump drive design, fast crimping
- Forged alloy steel crimping head, long service lifespan
- With safety relief valve, automatic pressure relief after standard output, stable crimping quality
- Crimping head can be rotated 180°, suitable for crimping at different angles
- Power: 14.4VDC battery, quick charge for 60 minutes
- It can be used about 70-150 crimping times after fully charged and the battery can be recharged 1000 times
- Main accessories: 1 charger, 1 plastic storage box



Figure 1



Figure 2



Figure 3



Figure 4

Spare Battery

Order Code	Specification	Price RM
TMHY70		
-00001P	14.4V Ni-MH	2772.00

Order Code	Type	Crimping Range			Standard Crimping Dies(mm ²)	Size(mm) (L x H x W)	Weight (kg)	Figure	Price RM
		(JIS mm ²)	(DIN mm ²)	(AWG/MCM)					
-06240C	C Type	8 - 250	10 - 240	8 / 240	10,16,25,35,70,95,120,150,185,240	320 × 310 × 75	3.3	1	26345.70
-06300D	Pin Type	/	10 - 300	8 / 600	10/16,25/35,50,70,95,120,150,185,240,300	300 × 310 × 75	3.1	2	26970.00
-06185E	Open Type	8 - 150	10 - 185	8 / 350	10/16,25/35,50/70,95/120,150,185	320 × 310 × 75	3	3	25222.00
-06240E	Open Type	8 / 240	10 - 240	8 / 400	10/16,25/35,50/70,95/120,150/185,240	335 × 310 × 75	3.3	4	26096.00

Remote Control Hydraulic Crimping Heads - Type C

- C-type forged alloy steel crimping head, long service lifespan
- Use with hydraulic pump, hydraulic pump order number TMHY33-01200P

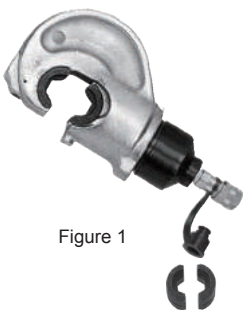

Figure 1

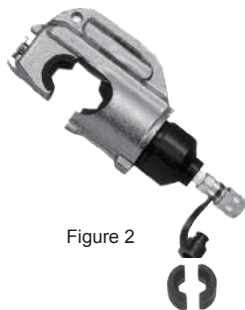

Figure 2



Figure 3



Figure 4

Order Code	Type	Load Capacity (Ton)	Crimping Range			Standard Crimping Dies(mm ²)	Opening (mm)	Length (mm)	Weight (kg)	Figure	Price RM
			(JIS mm ²)	(DIN mm ²)	(AWG/MCM)						
-11025C	C Type	11	38 - 325	35 - 400	#2 - 500	35,50,70,95,120,150,185,240,300,400	25	210	3.60	1	7375.30
-12030C	C Type	12	38 - 325	35 - 400	#2 - 750	35,50,70,95,120,150,185,240,300,400	30	220	4.00	2	7928.10
-12038C	C Type	12	38 - 325	35 - 400	#2 - 750	35,50,70,95,120,150,185,240,300,400	38	245	4.80	3	8131.70
-12042C	C Type	12	38 - 325	35 - 400	#2 - 750	35,50,70,95,120,150,185,240,300,400	42	250	5.30	3	8875.60
-15050C	C Type	15	38 - 630	35 - 630	#2 - 1500	35,50,70,95,120,150,185,240,300,400,500,630	50	300	7.00	4	13994.20

Hydraulic Crimping Pliers

- High-low pressure two-stage piston pump drive design, fast crimping
- Cutting head can be rotated 180°, suitable for cutting at different angles
- With safety relief valve, stable cutting quality



Figure 1

Figure 2

Figure 3

Figure 4

Figure 5

Order Code TMHY71	Type	Output (Ton)	Crimping Range (JIS mm ²) (DIN mm ²) (AWG/MCM)			Standard Crimping Dies(mm ²)	Length (mm)	Weight (kg)	Figure	Price RM
-10185A	Rotary Type	10	14 - 150	16 - 185	300	Male Dies (3):16-25,35-70,70-185 Female Dies (5):16,25-35,50-80,70-120,150-185	528	5.2	1	8240.80
-10240A	Rotary Type	10	22 - 200	25 - 240	500	Male Dies (4):25,35-60,70-185,240 Female Dies (5):25-35,50-70,95-120,150-185,240	528	5.2	2	8490.60
-18400D	Pin Type	18	14 - 325	16 - 400	750	Male Dies (4):16,25-35,50-120,150-400 Female Dies (8):16-25,35-70,95-120,150,185,240,300,400	650	6.2	3	10113.80
-12400D	Pin Type	12	38 - 325	35 - 400	750	35,50,70,95,120,150,185,240,300,400	528	5.2	4	10862.90
-18630D	Pin Type	18	38 - 630	35 - 630	1200	35,50,70,95,120,150,185,240,300,400,500,630	650	6.5	5	14983.40

Hydraulic Crimping Pliers

- High-low pressure two-stage piston pump drive design, fast crimping
- Forged alloy steel crimping head, long service lifespan
- With safety relief valve, stable crimping quality
- Main accessories: 1 plastic storage box

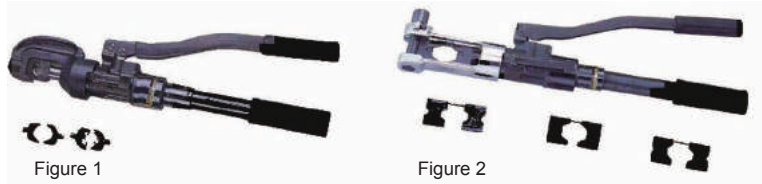

Figure 1

Figure 2



Figure 3

Figure 4

Special matching die

Order Code TMHY71	Type	Output (Ton)	Crimping Range (JIS mm ²) (DIN mm ²) (AWG/MCM)			Special Crimping Dies(mm ²)	Length (mm)	Weight (kg)	Figure	Price RM
-28240C	C Type	8	8 - 250	10 - 240	400	10,16,25,35,50,70,95,120,150,185,240	528	5.2	1	11362.40
-28300D	Pin Type	8	/	10 - 300	600	10/16,25/35,50/70,95/120,150,185,240,300	520	3.4	2	10862.90
-26185E	Open Type	6	8 - 150	10 - 185	350	10/16,25/35,50/70,95/120,150,185	370	2	3	9988.90
-26240E	Open Type	6	8 - 240	10 - 240	500	10/16,25/35,50/70,95/120,150,185,240	400	2.2	4	10862.90

18 Ton Battery Powered Hydraulic Cable Cutter - Heavy Duty

- Cutting head can be rotated 180°, suitable for cutting at different angles
- With safety relief valve, automatic pressure relief after standard output, stable cutting quality
- Power: 14.4VDC battery, quick charge for 60 minutes
- It can be used about 70-150 crimping times after fully charged and the battery can be recharged 1000 times
- Accessories: 1 charger and 1 plastic storage box



Spare Battery

Order Code	Specification	Price RM
TMHY70		
-00001P	14.4V Ni-MH	2772.00

Order Code	Steel Cable (mm)	Size (mm) (L x H x W)	Weight (kg)	Price RM
TMHY72				
-18032H	32	280 x 310 x 75	9.2	31839.60

- The above cutting parameters may vary due to the cutting material

12 Ton Battery Powered Hydraulic Cable Cutter - Heavy Duty

- Cutting head can be rotated 180°, suitable for cutting at different angles
- With safety relief valve, automatic pressure relief after standard output, stable cutting quality
- Power: 14.4VDC battery, quick charge for 60 minutes
- It can be used about 70-150 crimping times after fully charged and the battery can be recharged 1000 times
- Accessories: 1 charger and 1 plastic storage box



Spare Battery

Order Code	Specification	Price RM
TMHY70		
-00001P	14.4V Ni-MH	2772.00

Order Code	Chain Rod (mm)	Copper & Aluminum round rod(mm)	Soft Iron Bar(mm)	Size (mm) (L x H x W)	Weight (kg)	Price RM
TMHY72						
-12025H	12	25	19	280 x 330 x 75	9.2	31839.60

- The above cutting parameters may vary due to the cutting material

6 Ton Battery Powered Hydraulic Cable Cutters

- Ergonomic design, light weight, one-handed operation, forward & reverse easy control button
- The blade is made of German alloy steel vacuum heat treatment, long service lifespan
- Cutting head can be rotated 360°, suitable for cutting at different angles
- With safety relief valve, automatic pressure relief after standard output, stable cutting quality
- Power: 14.4VDC battery, quick charge for 60 minutes
- It can be used about 70-150 crimping times after fully charged and the battery can be recharged 1000 times
- Accessories: 1 charger and 1 plastic storage box



Figure 1



Figure 2

Order Code	Size (mm) (L x H x W)	Figure	Price RM
TMHY72			
-06020B	280 x 310 x 75	1	23598.80
-06025B	290 x 310 x 75	1	25471.70
-06040B	428 x 310 x 75	2	25471.70

Spare Battery

Order Code	Specification	Price RM
TMHY70		
-00001P	14.4V Ni-MH	2772.00

Order Code	Output (Ton)	Weight (kg)	Steel Cable (mm)			Round Metal Bar (mm)				Steel Stranded Wire (mm)				Cable (mm)			Figure		
			6 strands x7	6 strands x12	6 strands x19	Soft Copper Bar	Soft Aluminum Bar	Soft Iron Bar	Reinforced Steel Bar	Steel Stranded Wire	Aluminum Stranded Wire	Copper Clad Aluminum Wire	1 strand x7	1 strand x19	Telephone Cable	Telecommunication Cable		Underground Cable	
TMHY72																			
-06020B	6	3.2	20	20	20	20	20	16	13	20	20	20	15	16	20	20	20	20	1
-06025B	6	3.3	18	25	25	25	25	20	16	25	25	25	20	20	25	25	25	25	1
-06040B	6	5.6	20	25	25	25	22	16	13	32	32	28.8	15	20	40	40	40	40	2

- The above cutting parameters may vary due to the cutting material

Professional Battery Powered Ratchet Cable Cutter

- Power: 14.4VDC battery, quick charge for 60 minutes
- It can be used about 50-100 crimping times after fully charged and the battery can be recharged 1000 times
- Accessories: 1 charger and 1 plastic storage box
- Overall dimensions (L × H × W): 106 × 376 × 118mm



Spare Battery

Order Code	Specification	Price RM
TMHY70	14.4V Ni-MH	2772.00

Order Code	Cutting Capacity (mm)					Price RM
TMHY74	Copper Stranded Wire	Aluminum Stranded wire	telephone line	Underground Cable	Guide Cable	
-00085A	32	28	85	50	85	21476.10

- The above cutting parameters may vary due to the cutting material

Battery Powered Ratchet Cable Cutter

- Power: 14.4VDC battery, quick charge for 60 minutes
- It can be used about 50-100 crimping times after fully charged and the battery can be recharged 1000 times
- Accessories: 1 charger and 1 plastic storage box
- Overall dimensions (L × H × W): 280 × 310 × 75mm



Spare Battery

Order Code	Specification	Price RM
TMHY70	14.4V Ni-MH	2772.00

Order Code	Cutting Capacity	Weight (kg)	Price RM
TMHY74	Cable Diameter(mm)Copper and Aluminum Cable(mm ²)		
-00055B	55 500(AWG 1000 MCM)	2	15732.50

- The above cutting parameters may vary due to the cutting material

Hydraulic Cable Cutters

- High-low pressure two-stage piston pump drive design, fast crimping
- The blade is made of German alloy steel vacuum heat treatment, long service lifespan
- Cutting head can be rotated 180°, suitable for cutting at different angles
- With safety relief valve, automatic pressure relief after standard output, stable cutting quality

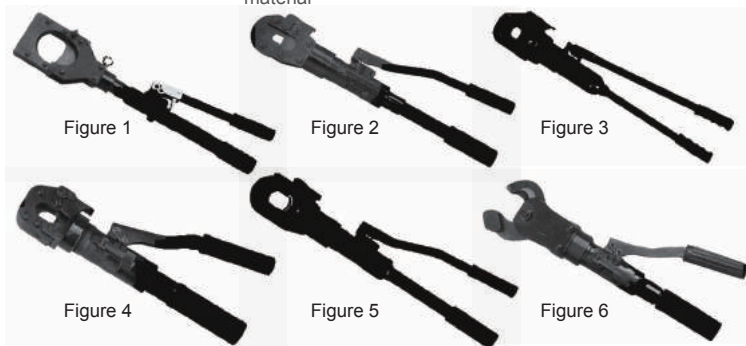

Order Code	Output (Ton)	Length (mm)	Weight (kg)	Steel Cable (mm)			Round Metal Bar (mm)				Steel Stranded Wire (mm)			Cable (mm)			Figure	Price RM			
				6 strands x7	6 strands x12	6 strands x19	Soft Copper Bar	Soft Aluminum Bar	Soft Iron Bar	Reinforced Steel Bar	Steel Stranded Wire	Aluminum Stranded Wire	Copper Clad Aluminum Wire	1 strand x7	1 strand x19	Telephone Cable			Telecommunication Cable	Underground Cable	
-03050B	3	695	7	/	/	/	/	/	/	/	/	28	46	/	/	/	85	50	50	1	12111.50
-06016B	6	560	4.7	/	/	/	16	16	16	14	/	/	/	/	/	/	/	/	/	2	12111.50
-20032B	20	670	11	32	32	32	32	32	25	25	25	25	25	32	22	25	/	/	32	3	18729.20
-20020B	20	670	10.5	/	/	/	19	19	19	20	/	/	/	/	/	/	/	/	20	3	18729.20
-06020B	6	390	2.8	20	20	20	20	20	16	13	20	20	20	/	15	15	20	20	20	4	9864.00
-07025B	7.5	426	4	18	25	25	25	25	20	/	25	25	25	20	20	25	25	25	25	4	12111.50
-06040B	6	560	6	22	25	25	25	22	16	13	32	32	/	20	25	40	40	40	40	5	11861.80
-06030B	6.5	460	3.8	/	/	/	/	/	/	/	/	32	28	/	/	/	30	30	30	6	12111.50

- The above cutting parameters may vary due to the cutting material

Standard Hydraulic Pullers

- Removable handle and 360° pressure, easy use in confined spaces
- Both jaw hook and jaw frame are made of high-strength alloy steel not easily deformed
- The hydraulic cylinder is made of one-piece solid steel forming, high safety factor
- Double positioning quick adjustment nut, save time and energy
- Adjustable Jaw Spread
- Blow moulded storage case



Order Code	Capacity (Ton)	Jaw Type	Jaw Reach (mm)	Jaw Spread (mm)	Stroke (mm)	G.W. (kg)	Price RM
-10401A	4	Short Jaw	165	30 - 200/260	55 - 105	7.20	5472.60
-10601A	6	Short Jaw	165	30 - 200/260	82 - 130	7.50	6271.80
-10602A	6	Long Jaw	195	30 - 200/300	82 - 180	8.80	6821.20
-10603A	6	Short Jaw & Long Jaw	165/195	30 - 200/300	82 - 180	10.30	8119.70
-10801A	8	Short Jaw	210	30 - 250/355	82 - 160	9.70	7470.40
-10802A	8	Long Jaw	240	30 - 300/380	82 - 240	11.10	7969.90
-10803A	8	Short Jaw & Long Jaw	210/240	30 - 300/380	82 - 240	13.13	9243.50
-11501A	15	Short Jaw	240	50 - 280/380	82 - 180	11.10	9368.30
-11502A	15	Long Jaw	320	50 - 350/410	82 - 280	26.26	13944.60
-11503A	15	Short Jaw & Long Jaw	240/320	50 - 350/410	82 - 280	28.40	16485.40

Hydraulic Puller Kits

- Triangular pressure plate with convex surface, horizontally hold tight to the workpiece, quick pulling and energy saving
- Triangular claw puller, synchronous open/close action with triangular pressure plate, saves time and energy, safe and fast
- Avoid damage to bearings, shafts or workpieces.
- Suitable for disassembly of bearings, bushings, gears, etc.
- Adjustable Jaw Spread
- Blow moulded storage case



Order Code	Type	Capacity (Ton)	Jaw Type	Jaw Reach (mm)	Jaw Spread (mm)	Stroke (mm)	G.W. (kg)	Price RM
-80601T	Standard Type	6	Short Jaw	165	30 - 200/260	82 - 130	12.80	11241.30
-80801T	Standard Type	8	Short Jaw	210	30 - 250/355	82 - 160	18.50	15986.00
-81501T	Standard Type	15	Short Jaw	240	30 - 280/380	82 - 180	20.20	15486.50
-91001T	Heavy Duty	10	Short Jaw	195	30 - 250/310	82 - 130	14.30	19731.80
-91201T	Heavy Duty	12	Short Jaw	240	30 - 300/370	82 - 160	23.00	17234.60
-92001T	Heavy Duty	20	Short Jaw	275	30 - 360/430	82 - 180	24.45	22728.50

Heavy Duty Hydraulic Pullers

- Removable handle and 360° pressure, easy to use in confined spaces
- The claw hooks and claw frame are made of high-strength alloy steel and are not easily deformed.
- The hydraulic cylinder is made of one-piece solid steel forming, high safety factor
- Double positioning quick adjustment nut, save time and energy
- Special heavy jaws (triangular section), higher safety and reliability
- Adjustable Jaw Spread
- Blow moulded storage case

Order Code	Capacity (Ton)	Jaw Type	Jaw Reach (mm)	Jaw Spread (mm)	Stroke (mm)	G.W. (kg)	Price RM
-21001H	10	Short Jaw	195	30 - 250/310	82 - 130	10.70	10342.20
-21002H	10	Long Jaw	250	30 - 280/340	82 - 180	14.10	12514.90
-21003H	10	Short Jaw & Long Jaw	195/250	30 - 280/340	82 - 180	18.30	15236.80
-21201H	12	Short Jaw	240	30 - 300/370	82 - 160	19.00	11690.80
-21202H	12	Long Jaw	280	30 - 330/400	82 - 240	23.30	12589.70
-21203H	12	Short Jaw & Long Jaw	240/280	30 - 330/400	82 - 240	24.00	15986.00
-22001H	20	Short Jaw	275	50 - 360/430	82 - 180	24.70	15236.80
-22002H	20	Long Jaw	330	50 - 380/450	82 - 280	29.30	18982.70
-22003H	20	Short Jaw & Long Jaw	275/330	50 - 380/450	82 - 280	32.80	22728.50
-22501H	25	Short Jaw	315	50 - 410/480	110 - 220	34.80	24226.80
-22502H	25	Long Jaw	380	50 - 440/540	110 - 330	43.80	26599.20
-22503H	25	Short Jaw & Long Jaw	315/380	50 - 440/540	110 - 330	64.35	32717.40
-23001H	30	Long Jaw	405	100 - 540/610	110 - 260	52.65	31033.50



Heavy Duty Hydraulic Puller Kits - Remote Control

- Can be used with manual, pneumatic and electric pump
- Adopt Germany made high-strength alloy steel tension spring, long service lifespan
- Hydraulic ram made of one-piece solid steel, high safety factor.
- With storage box and anti-shedding safety net
- Metal case



Order Code	Capacity (Ton)	Jaw Type	Jaw Reach (mm)	Jaw Spread (mm)	Stroke (mm)	G.W. (kg)	Jaw Type	Price RM
TMHY47								
-11501H	15	Short Jaw	240	50 - 280/380	82 - 180	20.66	-	10085.90
-11502H	15	Long Jaw	320	50 - 350/410	82 - 280	22.15	-	12486.10
-11703H	17.5	Short Jaw	275	50 - 360/430	82 - 180	30.35	Lifetime warranty jaw	23473.90
-11704H	17.5	Long Jaw	330	50 - 380/450	82 - 280	35.25	Lifetime warranty jaw	26845.20
-12203H	22.5	Short Jaw	315	50 - 410/480	110 - 220	39.50	Lifetime warranty jaw	24722.50
-12204H	22.5	Long Jaw	380	50 - 440/540	110 - 330	49.25	Lifetime warranty jaw	25971.10
-12703H	27.5	Short Jaw	405	50 - 540/610	110 - 260	53.50	Lifetime warranty jaw	28842.90
-15003H	50	Short Jaw	465	580 - 750	125 - 275	123.30	Lifetime warranty jaw	77164.20
-15004H	50	Long Jaw	635	580 - 1000	125 - 425	133.50	Lifetime warranty jaw	82158.70

700Bar Double-speed Hydraulic Hand Pump

- Compact and lightweight design
- Double-speed design, faster and more efficient
- Large tank capacity for most tools
- Can be equipped with TMHY47 series hydraulic products
- Internal safety valve prevents overload and misoperation caused by manually set pressure value.
- Outlet thread: 3/8"NPT
- Dimensions (L x W x H): 536 x 137 x 142mm



Order Code	Type	Pressure rating (Bar)		Oil displacement per stroke (cc)		Usable oil capacity (cm³)	Weight (kg)	Price RM
		Low stage	High stage	Low stage	High stage			
TMHY33								
-01200P	Single-speed	14	700	15.5	2.8	1200	9	2316.60

Hydraulic Hoses



Order Code	Hose end		Hose Length (m)	Weight (kg)	Price RM
	End 1	End 2			
TMHY81					
-01180H	3/8"	3/8"	1.8	0.9	238.00
-01300H	3/8"	3/8"	3.0	1.4	309.50
-01600H	3/8"	3/8"	6.0	2.8	499.90

Hydraulic Couplings - Male

Order Code	Connector type	Maximum flow (L/min)	Price RM
TMHY81			
-01100M	Large flow connector	40	132.20



7Pc 3 Jaw Hydraulic Gear Puller Kit

- Widely used in industrial equipment, agricultural machinery and auto repair
- For removing bearings, gears, chains, etc.
- Jaw reach: 177mm
- Puller range: 191mm / 7-1/2"
- Fixed seat: 37.7mm
- 1 x adapter
- Load capacity: 12 ton



Order Code	Load capacity (Ton)	Price RM
TMHY88		
-01207T	12	1229.80

11Pc 5 Jaw Hydraulic Gear Puller Kit

- Widely used in industrial equipment, agricultural machinery and auto repair
- For removing bearings, gears, chains, etc.
- Jaw reach: 177mm
- Puller range: 191mm / 7-1/2"
- Extension Rod: 280mm / 11"
- Rotary wrench: 200mm / 8"
- Fixed seat: 37.7mm
- 1 x adapter
- Load capacity: 12 ton



Order Code	Load capacity (Ton)	Price RM
TMHY88		
-01211T	12	1885.20

19Pc 2 / 3 Jaw Interchangeable Hydraulic Gear Puller Kit

- Widely used in industrial equipment, agricultural machinery and auto repair
- For removing bearings, gears, chains, etc.
- Can be used as a 2 or 3 legged puller with the same head
- Adjustable puller legs, use from 4" - 10" (100mm - 250mm)
- 4" (100mm), 6" (150mm), 8" (200mm), 10" (250mm)
- Puller range: 250mm / 10"
- Jaw reach: 173mm
- 1 x combination head
- 1 x adapter
- 6 x leg connectors
- 6 x screw nuts and washers
- Load capacity: 12 ton



Order Code	Load capacity (Ton)	Price RM
TMHY88		
-01219T	12	1319.70

Hydraulic Shop Presses

- Comprehensive range of workshop presses are designed for the professional user in automotive and industrial applications.
- The two-column design with Sturdy steel frame with end braces and thick wide feet for extra stability.
- Regardless of applications or budget TEMO has all professional to suit your requirements.
- Suitable for pressing , bending, forming , punching, shearing and extruding, Heavy-Duty frames built for tough and daily use in workshop.
- Fitted with extra long hydraulic pump handle increases flexibility and work load when working with large work pieces
- Work bed height is adjustable.
- Manual operation , manual & pneumatic operation ,foot Controlled Manual & Pneumatic Operation model are available.
- Using foot pedal keeps hands free for fine positioning of the work piece before pressing starts.

10 tonne
(manual operation)



20 tonne
(Manual & Pneumatic Operation)



30 tonne
(manual operation)



50 tonne
(Manual & Pneumatic Operation)



50 tonne
(Foot Controlled Manual & Pneumatic Operation)



Order Code	Model	Capacity (Toone)	maximum Working Width (mm)	Maximum Working Depth (mm)	Size (mm)	Weight (kg)	Price RM
-10003A	Manual	10	0 - 350	175	775 x 550 x 180	48	2814.80
-20002A	Manual & Pneumatic	20	0 - 910	185	1565 x 185 x 145	61.8	4567.70
-30001A	Manual	30	0 - 840	160	1620 x 380 x 310	166.5	7535.30
-50001A	Manual & Pneumatic	50	0 - 890	175	1792 x 920 x 380	285	11111.40
-50021A	Foot Controlled Manual & Pneumatic	50	0 - 920	200	2008 x 1168 x 428	339	15868.30

Hydraulic Bottle Jacks

- Base and reservoir machine welded with an adjusting notched saddle.
- Fitted with an overload valve. Supplied with 2pc handle
- Use on firm level surface to ensures safety.
- Ideal for use on car lift by mechanics. Suitable for other high risk environments such as rescue operations.
- Comply with CE, GS standards.



Order Code	Max Load Capacity (Tonne)	Height Min. (mm)	Height Max. (mm)	Gross Weight (kg)	Price RM
-01003B	3T	194	372	3.4	191.80
-01005B	5T	216	413	4.6	228.10
-01008B	8T	230	457	5.8	240.20
-01012B	12T	230	465	7.7	276.60
-01016B	16T	230	460	8.2	317.80
-01020B	20T	242	452	10.5	354.20
-01032B	32T	260	415	19.1	657.30
-01050B	50T	270	430	26.3	877.90

20 Ton Remote Control Hydraulic Puncher for Channel & Angle Steel

- Output power : 20 tons
- Weight : 14.0kg
- Maximum punching thickness: 5mm
- Maximum punching aperture: 20.5mm
- Operating pressure: 700Bar
- High-speed steel punching die, Longer life
- 4 sets of punching dies (male and female dies) included: 3/8", 1/2", 5/8", 3/4"
- Accessories: 1 storage tank
- Ptinal Hydraulic pump is required, hydraulic pump is ordered No. TMHY33-01200P

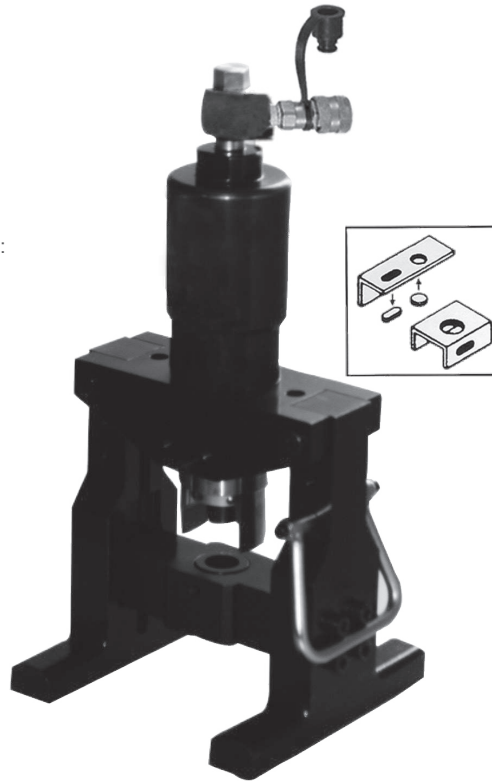

Order Code	Size (mm) (L x W x H)	Weight (kg)	Price RM
TMHY77 -00020A	190 x 180 x 430	17.5	15002.70

30 Ton Remote Control Single-acting Hydraulic Puncher

- Output power : 30 tons
- Weight : 16.5kg
- Maximum punching thickness: 10mm
- Maximum throat depth: 10mm
- Maximum punching aperture: 20.5mm
- Operating pressure: 700Bar
- High-speed steel punching die, Longer life
- 4 sets of punching dies (male and female dies) included: 3/8", 1/2", 5/8", 3/4"
- Accessories: 1 storage tank
- Optinal Hydraulic pump is required, hydraulic pump is ordered No. TMHY33-01200P

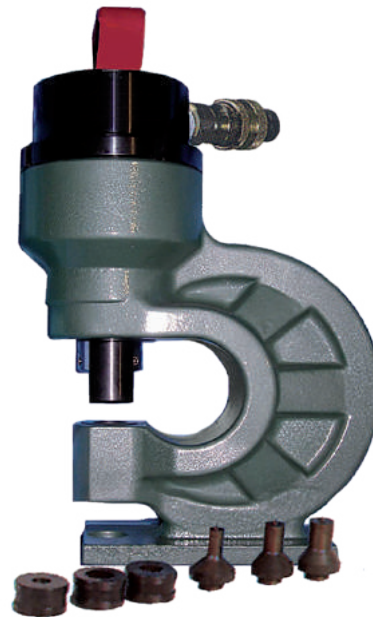

Order Code	Size (mm) (L x W x H)	Weight (kg)	Price RM
TMHY77 -01030A	370 x 110 x 225	13.5	15856.20



TEMO®

Hand Tools

www.temomalaysia.com

Professional Roller Cabinets - Black / Silver

- Self-locking function on fully-open drawers, with only one drawer open at a time
- Special handle design, easy to open
- Ball bearing slide design, smooth operation
- Plastic corner guards, damage prevention
- Tool hangers on the sides
- 5 "Heavy duty TPR polyurethane caster wheels, durable, high load-bearing capacity, non-marking. 4 rotating caster wheels (2 with brakes)

7 drawers



- Removable PP high strength anti-impact, non-slip carved top plate
- **Can install with Bench Vice**
- Cabinet size: 678 × 459 × 1022mm
- Upper 5 drawer size: 568 × 398 × 75mm
- Lower 2 drawer size: 568 × 398 × 154mm
- Drawer load: 40kg/each
- Total load: 500kg

Order Code	No. of Drawer	Net weight (kg)	Gross weight (kg)	Price RM
TMTB01				
-10710A	7 drawers	64.5	70.0	3237.20
-10610A	6 drawers	59.0	63.7	3445.40

3 Drawer Professional Tool Chest - Black / Silver

- ABS high-strength impact-resistant, non-slip graining top plate
- Self-locking function on fully-open drawers, with only one drawer open at a time
- Special handle design, easy to open
- Ball bearing slide design, smooth operation
- Plastic corner guards, damage prevention
- Cabinet size: 678 × 459 × 365mm
- Drawer size: 568 × 398 × 75mm
- Drawer load: 40kg/each
- Total load: 200kg



Order Code	No. of Drawer	Net weight (kg)	Gross weight (kg)	Price RM
TMTB02				
-10310A	3	28.5	31.9	1952.60

Accessories	Order Code	Price RM
Lock	-02010L	62.60

7 Drawer Professional Tool Chest - Black / Silver

- Black powder box coating, dirt, oil, corrosion-resistant
- Embossed diamond pattern drawer panel, increase in strength, aesthetics
- Aluminum wide trim drawer handle, increased convenience, aesthetics
- Ball bearing slide design, smooth operation
- Hydraulic struts, cabinet roof opens with little effort
- Piano hinges for safe operation

• Cabinet size: 678 × 459 × 365mm

- Drawer size:
 - Upper 4 drawers: 270 × 375 × 47mm
 - Number 5: 570 × 375 × 47mm
 - Number 6: 570 × 375 × 72mm
 - Number 7: 570 × 375 × 97mm
 - 568 × 398 × 75mm
- Drawer load: 40kg/each
- Total load: 175kg



Order Code	No. of Drawer	Net weight (kg)	Gross weight (kg)	Price RM
TMTB02				
-20710B	7	30.0	33.9	1448.10

Accessories	Order Code	Price RM
Lock	-02010L	62.60

4 Drawer Industrial Tool Chest - Black

- Black powder box coating, dirt, oil, corrosion-resistant
- Embedded aluminum handle, convenient handling, increased aesthetics
- Ball bearing slide design, smooth operation
- Heavy-duty Struts
- Piano hinges for safe operation
- Cabinet size: 660 × 432 × 492mm
- Drawer size: 551 × 396 × 80mm
- Drawer load: 25kg/each
- Total load: 140kg



Order Code	No. of Drawer	Net weight (kg)	Gross weight (kg)	Price RM
TMTB02	4	27.0	30.0	1247.20
-30410B				

Accessories	Order Code	Price RM
Lock	-02010L	62.60

18" Professional Cantilever Tool Box - Black

- Black powder box coating, dirt, oil, corrosion-resistant
- Box pattern surface, reinforcing ribs at the bottom, greatly increasing the strength of the box, practical and aesthetically pleasing
- Heavy-duty hinge, smooth operation, strong and durable
- Padlockable
- Box size: 465 × 220 × 240mm
- Tool container size:
Top 463 × 108 × 55mm
Middle 463 × 108 × 57mm
Bottom 463 × 218 × 120mm



Order Code	Net weight (kg)	Gross weight (kg)	Price RM
TMTB03	6.28	7.10	559.40
-10510A			

18" Industrial Cantilever Tool Box - Black

- Black powder box coating, dirt, oil, corrosion-resistant
- Heavy-duty hinge, smooth operation, strong and durable
- Heavy-duty safety buckle
- Box size:
Tool container size: 460 × 200 × 224mm
Top 458 × 98 × 50mm
Middle 458 × 98 × 50mm
Bottom 458 × 198 × 100mm

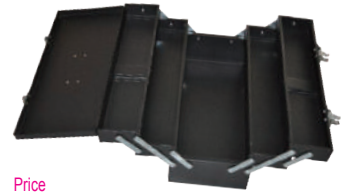

Order Code	Net weight (kg)	Gross weight (kg)	Price RM
TMTB03	4.22	5.30	349.10
-20510B			

Foam Tool Organizers

- Effective management of tools, easy categorization, loss minimization
- Necessary to achieve the 5S system
- A variety of materials, color options
- Provide design, blueprint and production
- Easily accomplish 5S system requirements
- Consult as necessary

Any Shapes as You Wish

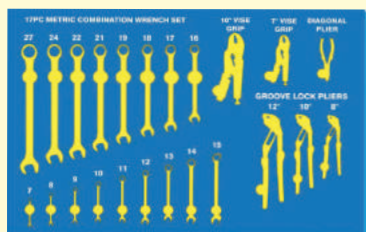
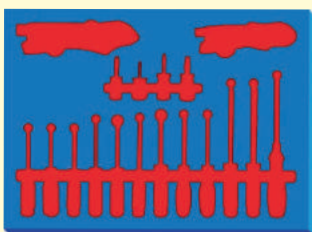
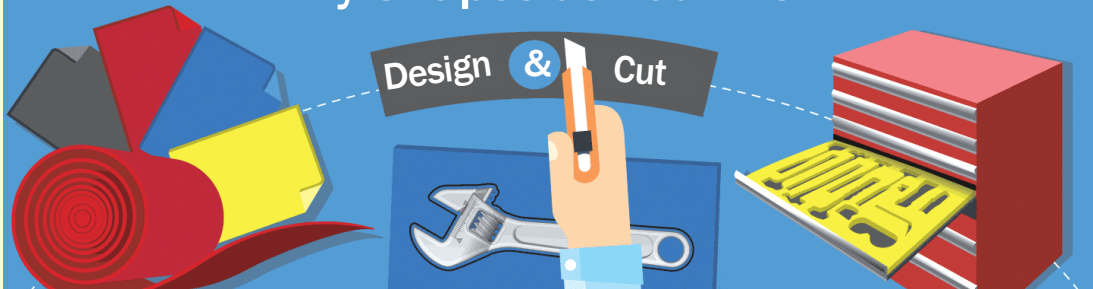

195Pc Industrial Engineer's Tool Kit

- Professional 6 Drawer Tool Trolley (black/silver) - 678x459x997mm
- Professional 3 Drawer Horizontal Tool Chest (black/silver) - 678x459x365mm
- 28-piece 1/2 "square metric socket sets (10 - 32mm)
- 7-piece industrial grade screwdriver set
- 38-piece 1/4 "square socket & screwdriver bit set
- 12-piece industrial-grade combination wrench set (6 - 32mm)
- 25-piece Metric Black Gold HSS Twist Drill (1.0 - 13mm)
- 7 " / 180mm industrial grade wire cutters
- 8 " / 200mm industrial long-nose pliers
- 7 " / 180mm industrial heavy-duty diagonal pliers
- 6 " / 150mm industrial grade flat nose pliers
- 10 " / 250mm curved locking pliers
- 12 "heavy-duty pipe wrench
- 14" aluminum-handle bolt cutters
- 12 " / 300mm hacksaw frame
- 12 " / 300mm Bi-metal hacksaw blade (10)
- 8 " / 200mm phosphate adjustable wrench
- 1.5 pound ball pein hammer
- 9-piece Metric ball point L-wrench set (1.5 - 10mm)
- 8-piece foldable torx wrench set (matte chrome, T9-T40)
- 6-piece assorted file set - 5x180mm
- 250x24x5.5mm flat file (second cut)
- 250x16.0x16.0mm triangle file (second cut)
- 250x24.0x7.0mm half-round file (second cut)
- 250x9.0x9.0mm round file (second cut)
- 5Mx19mm Powergrip metric steel tape measure
- Professional heavy-duty utility knife
- 18mm metal slot anti skid plastic handle utility knife - 8 knots
- 20 pieces metric feeler gauge - 0.05 ~ 1.00mm
- 1.5kgs magnetic pick up tool
- 50mm flexible inspection mirror
- 6 pieces punch set
- 8-1 / 4 " / 210mm professional stainless steel multi-purpose scissors
- 190mm 125-250V electrical test pen
- Safety glasses
- Rechargeable head-mounted work light
- Automatic range digital multimeter

186Pc Industrial Engineer's Tool Kit

- Professional 6 drawer tool trolley (black/silver) - 678x459x997mm
- Professional 3 drawer horizontal tool chest (black/silver) - 678x459x365mm
- 30 pieces 1/2 "square mm/inch socket set (8 - 24mm & 3/8" - 7/8 ")
- 6-piece industrial screwdriver set
- 6-piece industrial-grade open-end wrench set (6 x 7 - 16 x 17mm)
- 8-piece industrial-grade double-ended ring wrench set (8 x 9 - 22 x 24mm)
- Industrial impact screwdriver set
- 7-piece 1/2 "Square hex socket bit set (H4 - H14)
- 9-piece metric standard length L-wrench set(1.5 - 10mm)
- 8-piece foldable torx wrench set (matte matt chrome, T9 - T40)
- 7 "insulated wire cutters
- 8" insulated long nose pliers
- 6 "insulated diagonal pliers
- 6 " / 150mm industrial flat nose pliers
- 10" / 250mm straight mouth pliers
- 7 " / 180mm, 10-40mm Straight external circlip pliers
- 7 " / 180mm, 12-65mm Straight internal circlip pliers
- 12 " / 300mm British style tinsnips
- 10" heavy-duty pipe wrench
- 12 " / 300mm hacksaw frame
- 12 " / 300mm Bi-metal hacksaw blade (10pcs)
- 10 " / 250mm phosphate adjustable wrench
- 400cc heavy-duty chrome plated grease gun
- 1.5lbs / 24oz / 0.68kg wood handle ball pein hammer
- 1lb / 16oz / 0.45kg wood handle claw hammer
- 6-piece Diamond Assorted File set(3 x 140mm)
- 6 -piece chisel punch set
- 6-piece high torque screw extractor set(No.1 - No.6)
- M1 - M10 tap wrenches • M5 - M20 tap wrenches
- black industrial scouring pad (10 / bag)
- 13 metric feelers gauge (0.05 ~ 1.00mm)
- 30 metric 60 ° pitch gauge (0.25 ~ 3.00mm)
- professional automatic retractable utility knife
- 7.5M x 25mm Powergrip metric steel tape measure
- 50 x 80 x 575mm flexible square inspection mirror with LED light
- 555mm flexible pick up tool with LED light
- pen-type digital multimeter
- foldable screen digital multimeter

Configuration 1



Configuration 2



Order Code	Configuration	Piece	Price RM
TMTK01			
-01195A	1	195	9178.00

Order Code	Configuration	Piece	Price RM
TMTK01			
-01186A	2	186	9279.70

108Pc Industrial Engineer's Tool Kit

- 18 "portable cantilever toolbox (460 x 200 x 224mm)
- 1/2 "square professional-grade quick release ratchet wrench
- 13-piece 1/2 "square hexagon socket set:
10mm, 11mm, 12mm, 13mm, 14mm, 15mm, 17mm
19mm, 22mm, 24mm, 27mm, 30mm, 32mm
- 1/2 " universal joint
- 1/2 " * 250mm (10") sliding T-handle
- 6-piece Industrial Open-ended Wrench set (6x7 - 16x17mm)
- 9-piece Metric ball point L-wrench set (1.5 - 10mm)
- 6-piece industrial grade screwdriver set
- 7 " / 180mm industrial grade wire cutters
- 8 " / 200mm industrial long-nose pliers
- 7 " / 180mm industrial heavy-duty diagonal pliers
- 6 " / 150mm industrial grade flat nose pliers
- 180mm curved locking pliers
- 8 " / 200mm phosphate adjustable wrench
- 1lb / 16oz / 0.45kg wood handle roundball pein hammer
- 8 " (medium cut) flat file
- 8 " (medium cut) triangle file
- 8 " (medium cut) half-round file
- 8 " (medium cut) round file
- 6-piece assorted daimond coated file set (4x160mm)
- 6-piece punch set
- 160mm Kevlar fiber scissors
- 250mm British style tinsnips
- 20 metric feelers gauge (0.05 ~ 1.00mm)
- 24 ISO 60 ° pitch gauge (0.25 ~ 6.00mm)
- Safety glasses



Order Code	No. of Cantilever Trays	Piece	Price RM
TMTK02			
-01108A	4	108	2021.00

26Pc Industrial Electrician's Tool Kit

- 18 "portable cantilever toolbox (465 x 220 x 240mm)
- 19 piece electrical insulation tool kit (see P199 for details)
- 8 " / 200mm insulated adjustable wrench
- 10 "insulated water pump pliers
- 8 " / 200mm insulated electric knife (straight edge)
- 5.0M x 19mm Powergrip metric steel tape measure
- Automatic range digital multimeter
- Rechargeable head-mounted work light



Order Code	No. of Cantilever Trays	Piece	Price RM
TMTK02			
-02026N	4	26	2429.60

58Pc Industrial Engineer's Tool Kit

- 18 "portable cantilever toolbox (460 x 200 x 224mm)
- 8-piece industrial grade combination wrench set(6 - 22mm)
- 6-piece industrial grade screwdriver set
- 9-piece Metric standard length L-wrenche set (1.5 - 10mm)
- 8-piece foldable torx wrench set (matt matte chrome, T9-T40)
- 7 " / 180mm industrial grade wire cutters
- 7 " / 180mm industrial heavy-duty diagonal pliers
- 8 " / 200mm industrial long-nose pliers
- 6 " / 150mm industrial-grade flat nose pliers
- 8 " / 200mm phosphating adjustable wrench
- 1lb / 16oz / 0.45kg wood handle ball pein hammer
- 6 piece of chisel punch set
- 10 piece diamond coated file set (3x140mm)
- 5M x 19mm Powergrip metric steel tape measure
- 18mm metal slot anti skid plastic handle utility knife - 8 knots
- Magnetic pick up tool
- 190mm 125-250V electric test pen



Order Code	No. of Cantilever Trays	Piece	Price RM
TMTK02			
-01058A	4	58	1302.40

53Pc Industrial Engineer's Tool Kit

- 18 "portable cantilever toolbox (460 x 200 x 224mm)
- 8-piece industrial grade Open-end Wrench set (8x9 - 22x24mm)
- 9-piece Metric standard length ball point L-wrenche set (1.5 - 10mm)
- 7-piece industrial grade screwdriver set
- 7 " / 180mm industrial grade wire cutters
- 8 " / 200mm industrial long-nose pliers
- 7 " / 180mm industrial heavy-duty diagonal pliers
- 6 " / 150mm industrial grade flat nose pliers
- 180mm straight jaw locking pliers
- 6 " / 150mm phosphate adjustable wrench
- 1.5lbs / 24oz / 0.68kg wood handle ball pein hammer
- 400cc heavy-duty chrome plated grease gun
- 8 " (second cut) flat file
- 8 " (second cut) triangle file
- 8 " (second cut) half-round file
- 8 " (second cut) round file
- 6-piece assorted file set (3 * 140mm)
- 6-piece chisel set
- 3.0M x 16mm Powergrip metric steel tape measure
- Automatic range digital multimeter
- LED light flexible shaft pick up tool
- 9mm metal slot anti skid plastic handle utility knife - 13 knots



Order Code	No. of Cantilever Trays	Piece	Price RM
TMTK02			
-01053A	4	53	1719.00

Tool Cabinets

- High-quality cold-rolled steel, pickling phosphate, electrostatic spray
- Single-slide drawer: load 80kg, 90% draw length
- Double-slides drawer: load 150kg, 100% draw length
- Drawer can be effectively separated according to customer requirements
- **Can be customized according to customer requirements**

Single-slide drawer

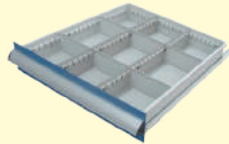

Double-slides drawer

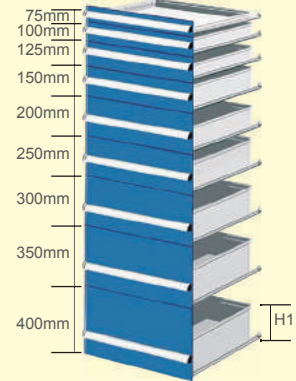
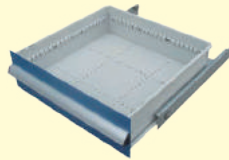

Double Tool Storages

- The specifications listed are for configuring the cabinet size of the single-slide drawer. If the double-slides drawers are required, the cabinet size is slightly larger
- **Can be customized according to customer requirements**

Single-slide		Double-slides		Size W x D x H(mm)	Drawer configuration (W: 411mm + 411mm)
Order Code TMTB20	Price RM	Order Code TMTB20	Price RM		
-00850L	4978.60	-00852L	5132.90	810 x 572 x 850	2 x (1 x 100, 2 x 200, 1 x 250)
-01150L	6455.30	-01152L	6609.60	810 x 572 x 1150	2 x (2 x 125, 2 x 150, 2 x 250)
-01450L	7755.70	-01452L	7910.00	810 x 572 x 1450	2 x (2 x 125, 2 x 150, 2 x 250, 1 x 400)
-00850D	5948.40	-00852D	6102.70	816 x 725 x 850	2 x (1 x 100, 2 x 200, 1 x 250)
-01150D	7843.90	-01152D	7998.20	816 x 725 x 1150	2 x (2 x 125, 2 x 150, 2 x 250)
-01450D	9739.40	-01452D	9893.70	816 x 725 x 1450	2 x (2 x 125, 2 x 150, 2 x 250, 1 x 400)

Single-slide		Double-slides		Size W x D x H(mm)	Drawer configuration (W: 564mm + 564mm)
Order Code TMTB20	Price RM	Order Code TMTB20	Price RM		
-11000L	6830.00	-11002L	6984.30	1116 x 572 x 1000	2 x (2 x 100, 2 x 200, 1 x 300)
-11350L	7755.70	-11352L	7910.00	1116 x 572 x 1350	2 x (1 x 100, 2 x 200, 1 x 350, 1 x 400)
-11000D	7579.40	-11002D	7733.70	1122 x 725 x 1000	2 x (2 x 100, 2 x 200, 1 x 300)
-11350D	8615.30	-11352D	8769.60	1122 x 725 x 1350	2 x (1 x 100, 2 x 200, 1 x 350, 1 x 400)

Single-slide		Double-slides		Size W x D x H(mm)	Drawer configuration (W: 717mm + 717mm)
Order Code TMTB20	Price RM	Order Code TMTB20	Price RM		
-21000L	7954.10	-21002L	8108.40	1422 x 572 x 1000	2 x (2 x 100, 2 x 200, 1 x 300)
-21450L	10753.30	-21452L	10907.60	1422 x 572 x 1450	2 x (2 x 75, 2 x 150, 2 x 250, 1 x 400)
-21000D	8857.80	-21002D	9012.10	1428 x 725 x 1000	2 x (2 x 100, 2 x 200, 1 x 300)
-21450D	12031.60	-21452D	12185.90	1428 x 725 x 1450	2 x (2 x 75, 2 x 150, 2 x 250, 1 x 400)

Single-slide		Double-slides		Size W x D x H(mm)	Drawer configuration (W: 411mm + 564mm)
Order Code TMTB20	Price RM	Order Code TMTB20	Price RM		
-31000L	6257.00	-31002L	6411.20	963 x 572 x 1000	2 x (2 x 100, 2 x 200, 1 x 300)
-31450L	7182.70	-31452L	7337.00	963 x 572 x 1450	2 x (2 x 125, 2 x 200, 2 x 350)
-31000D	7292.90	-31002D	7447.20	969 x 725 x 1000	2 x (2 x 100, 2 x 200, 1 x 300)
-31450D	8813.70	-31452D	8968.00	969 x 725 x 1450	2 x (2 x 125, 2 x 200, 2 x 350)

Single-slide		Double-slides		Size W x D x H(mm)	Drawer configuration (W: 564mm + 717mm)
Order Code TMTB20	Price RM	Order Code TMTB20	Price RM		
-41000L	7403.10	-41002L	7557.40	1270 x 572 x 1000	2 x (2 x 100, 2 x 200, 1 x 300)
-41350L	9100.20	-41352L	9254.50	1270 x 572 x 1350	2 x (2 x 125, 3 x 200, 1 x 400)
-41000D	8240.60	-41002D	8394.90	1276 x 725 x 1000	2 x (2 x 100, 2 x 200, 1 x 300)
-41350D	9915.70	-41352D	10070.00	1276 x 725 x 1350	2 x (2 x 125, 3 x 200, 1 x 400)

Double Tool Storages

- Optional shelves (shelves can be 25mm in height adjustment, load 100kg)
- Desktop, casters, handles, siding and other accessories can be configured to suit customer needs
- The specifications listed are for configuring the cabinet size of the single-slide drawer. If the double-slides drawers are required, the cabinet size is slightly larger
- **Can be customized according to customer requirements**

Single-slide		Double-slides		Size W x D x H(mm)	Drawer configuration	shelve
Order Code TMTB20	Price RM	Order Code TMTB20	Price RM			
-40700L	3887.60	-40702L	4041.80	870 x 572 x 700	2 x 100, 2 x 200	1
-40850L	4449.60	-40852L	4603.90	870 x 572 x 850	3 x 100, 1 x 200, 1 x 250	1
-41100L	5132.90	-41102L	5287.20	870 x 572 x 1000	3 x 100, 2 x 150, 1 x 300	2
-41150L	5485.50	-41152L	5639.80	870 x 572 x 1150	1 x 100, 2 x 150, 2 x 200, 1 x 250	2
-41450L	6830.00	-41452L	6984.30	870 x 572 x 1450	2 x 100, 2 x 150, 3 x 200, 1 x 250	3
-40700D	4515.70	-40702D	4670.00	876 x 725 x 700	2 x 100, 2 x 200	1
-40850D	5199.00	-40852D	5353.30	876 x 725 x 850	3 x 100, 1 x 200, 1 x 250	1
-41100D	6014.50	-41102D	6168.80	876 x 725 x 1000	3 x 100, 2 x 150, 1 x 300	2
-41150D	6411.20	-41152D	6565.50	876 x 725 x 1150	1 x 100, 2 x 150, 2 x 200, 1 x 250	2
-41450D	7998.20	-41452D	8152.50	876 x 725 x 1450	2 x 100, 2 x 150, 3 x 200, 1 x 250	3
-50700L	4361.40	-50702L	4515.70	1023 x 572 x 700	2 x 100, 2 x 200	1
-50850L	5022.70	-50852L	5177.00	1023 x 572 x 850	3 x 100, 1 x 200, 1 x 250	1
-51000L	5794.10	-51002L	5948.40	1023 x 572 x 1000	3 x 100, 2 x 150, 1 x 300	2
-51150L	6190.80	-51152L	6345.10	1023 x 572 x 1150	1 x 100, 2 x 150, 2 x 200, 1 x 250	2
-51450L	7733.70	-51452L	7888.00	1023 x 572 x 1450	2 x 100, 2 x 150, 3 x 200, 1 x 250	3
-50700D	4780.20	-50702D	4934.50	1029 x 725 x 700	2 x 100, 2 x 200	1
-50850D	5573.70	-50852D	5728.00	1029 x 725 x 850	3 x 100, 1 x 200, 1 x 250	1
-51000D	6455.30	-51002D	6609.60	1029 x 725 x 1000	3 x 100, 2 x 150, 1 x 300	2
-51150D	6874.10	-51152D	7028.40	1029 x 725 x 1150	1 x 100, 2 x 150, 2 x 200, 1 x 250	2
-51450D	8615.30	-51452D	8769.60	1029 x 725 x 1450	2 x 100, 2 x 150, 3 x 200, 1 x 250	3



Single-slide		Double-slides		Size W x D x H(mm)	Drawer configuration	shelve
Order Code TMTB20	Price RM	Order Code TMTB20	Price RM			
-60700L	3061.00	-60702L	3215.30	870 x 572 x 700	1 x 100	1
-61150L	4317.40	-61152L	4471.60	870 x 572 x 1150	2 x 100	2
-61450L	5132.90	-61452L	5287.20	870 x 572 x 1450	3 x 100	2
-60700D	3391.60	-60702D	3545.90	876 x 725 x 700	1 x 100	1
-61150D	4802.30	-61152D	4956.50	876 x 725 x 1150	2 x 100	2
-61450D	5705.90	-61452D	5860.20	876 x 725 x 1450	3 x 100	2
-70700L	3435.70	-70702L	3590.00	1023 x 572 x 700	1 x 100	1
-71150L	4714.10	-71152L	4868.40	1023 x 572 x 1150	2 x 100	2
-71450L	5882.30	-71452L	6036.50	1023 x 572 x 1450	3 x 100	2
-70700D	3766.30	-70702D	3920.60	1029 x 725 x 700	1 x 100	1
-71150D	5441.40	-71152D	5595.70	1029 x 725 x 1150	2 x 100	2
-71450D	6576.50	-71452D	6730.80	1029 x 725 x 1450	3 x 100	2



Rendering of desktop, peg board, casters, handles configuration

Rendering of desktop, peg board configuration



Roller Cabinets with Tool Panels

- A - Type/Single-slide, B - Type/Double-slides
- Can be customized according to customer requirements



Single-slide	
Order Code	Price
TMTB21	RM
-10820A	3810.40

Double-slides	
Order Code	Price
TMTB21	RM
-10820B	4405.50

Size W x D x H(mm) :
564 x 572 x 820

Drawer configuration (mm):
2 x 100, 1 x 150, 1 x 200

Tool Panel Height (mm): 550

Caster wheels:
2 rotating 2 fixed,
4 "polyurethane



Single-slide	
Order Code	Price
TMTB21	RM
-10870A	3964.70

Double-slides	
Order Code	Price
TMTB21	RM
-10870B	4758.20

Size W x D x H(mm)
564 x 572 x 870

Drawer configuration (mm):
3 x 100, 2 x 150

Tool Panel Height (mm): 550

Caster wheels:
2 rotating 2 fixed,
4 "polyurethane



Single-slide	
Order Code	Price
TMTB21	RM
-10970A	4603.90

Double-slides	
Order Code	Price
TMTB21	RM
-10970B	5287.20

Size W x D x H(mm)
564 x 572 x 970

Drawer configuration (mm):
2 x 75, 2 x 100,
1 x 150, 1 x 200

Tool Panel Height (mm): 550

Caster wheels:
2 rotating 2 fixed,
4 "polyurethane



Single-slide	
Order Code	Price
TMTB21	RM
-20870A	4868.40

Double-slides	
Order Code	Price
TMTB21	RM
-2087AB	5639.80

Size W x D x H(mm)
717 x 572 x 870

Drawer configuration (mm):
3 x 100, 2 x 150

Tool Panel Height (mm): 550

Caster wheels:
2 rotating 2 fixed,
4 "polyurethane



Single-slide	
Order Code	Price
TMTB21	RM
-20970A	5287.20

Double-slides	
Order Code	Price
TMTB21	RM
-20970B	6014.50

Size W x D x H(mm)
717 x 572 x 970

Drawer configuration (mm):
2 x 75, 2 x 100,
1 x 150, 1 x 200

Tool Panel Height (mm): 550

Caster wheels:
2 rotating 2 fixed,
4 "polyurethane



Single-slide	
Order Code	Price
TMTB21	RM
-30870A	2928.80

Double-slides	
Order Code	Price
TMTB21	RM
-30870B	3083.10

Size W x D x H(mm)
564 x 572 x 870

Drawer configuration (mm):
1 x 100

Locker Height (mm): 460

Tool Panel Height (mm): 550

Caster wheels:
2 rotating 2 fixed,
4 "polyurethane

Large Combination Roller Cabintes

- Can be customized according to customer requirements



- 30mm composite desktop
- 1 shelf
- Drawer configuration (mm): 3 x 100, 2 x 150
- Caster wheels: 2 rotating 2 fixed, 5 "polyurethane

Single-slide		Double-slides		Size W x D x H (mm)
Order Code	Price RM	Order Code	Price RM	
TMTB22	6190.80	-40872L	6345.10	1150 x 600 x 870



- 30mm composite desktop
- 1 shelf
- Drawer configuration (mm): 2 x 100, 4 x 150, 2 x 200
- Caster wheels: 2 rotating 2 fixed, 5 "polyurethane

Single-slide		Double-slides		Size W x D x H (mm)
Order Code	Price RM	Order Code	Price RM	
TMTB22	7229.40	-41872L	8097.80	1150 x 600 x 870



- 30mm composite desktop
- 1 shelf, 1 tool panel (450mm)
- Drawer configuration (mm): 2 x 75, 1 x 100, 2 x 200
- Caster wheels: 2 rotating 2 fixed, 5 "polyurethane

Single-slide		Double-slides		Size W x D x H (mm)
Order Code	Price RM	Order Code	Price RM	
TMTB22	6411.20	-40922L	6565.50	1150 x 600 x 870

Service Carts

- Single-slide drawer: load 80kg, 90% draw length
- Caster wheels: 2 rotating 2 fixed, 4 "polyurethane
- Can be customized according to customer requirements

Drawers on Top



Order Code	Size W x D x H (mm)	Drawer configuration (mm)	Drawers Height (mm)	Roof	Price RM
TMTB23					
-10800A	411 x 572 x 800	2 x 100	300	1	2220.10
-10850A	411 x 572 x 850	2 x 100	300	1	2242.10
-10900A	411 x 572 x 900	2 x 150	400	1	2374.40
-11000A	411 x 572 x 1000	2 x 150	400	1	2418.40
-20800A	564 x 572 x 800	2 x 100	300	1	2660.90
-20850A	564 x 572 x 850	2 x 100	300	1	2682.90
-20900A	564 x 572 x 900	2 x 150	400	1	2881.30
-21000A	564 x 572 x 1000	2 x 150	400	1	2925.40
-30800A	717 x 572 x 800	2 x 100	300	1	3057.60
-30850A	717 x 572 x 850	2 x 100	300	1	3079.70
-30900A	717 x 572 x 900	2 x 150	400	1	3278.00
-31000A	717 x 572 x 1000	2 x 150	400	1	3322.10

Drawers below



Order Code	Size W x D x H (mm)	Drawer configuration (mm)	Drawers Height (mm)	Top frame	Price RM
TMTB23					
-10800B	411 x 572 x 800	2 x 100	300	1	2220.10
-10850B	411 x 572 x 850	2 x 100	300	1	2242.10
-10900B	411 x 572 x 900	2 x 150	400	1	2374.40
-11000B	411 x 572 x 1000	2 x 150	400	1	2418.40
-20800B	564 x 572 x 800	2 x 100	300	1	2660.90
-20850B	564 x 572 x 850	2 x 100	300	1	2682.90
-20900B	564 x 572 x 900	2 x 150	400	1	2881.30
-21000B	564 x 572 x 1000	2 x 150	400	1	2925.40
-30800B	717 x 572 x 800	2 x 100	300	1	3057.60
-30850B	717 x 572 x 850	2 x 100	300	1	3079.70
-30900B	717 x 572 x 900	2 x 150	400	1	3278.00
-31000B	717 x 572 x 1000	2 x 150	400	1	3322.10

TEMO[®] Professional Heavy Duty Drawer Cabinet Series
EXCELLENT

- Center locking system : Fully Imported
- Advanced technology prevents opening more than one drawer at a time.
- Release mechanism feature ensures that only one drawer will be open at a time- no other drawer can be opened.
- Fitted with high quality lock and 5 coded keys , key-alked , master key can be duplicated for top security.
- Lock compatible : below 1/2000
- Each drawer have an evenly distributed load capacity of 100kg for normal and 200kg for tube type drawer respectively.
- Ball bearing drawer slides with Heavy-duty load capacity create a smooth running action.
- One piece steel of cabinets body :3mm thickness plate.
- Multiple colour selections : (Blue, Green, Grey, Silver) • Can be customized according to customer requirements.

4 Drawer Cabinet



Order Code	Model	Size (mm)	Drawer Configuration (mm)	Drawer Type	Drawer Opening	Price RM
TMTB30						
-10505A	No.1	564 x 573 x 600(h)	75 x 2	Normal	87%	3030.60
			150 x 1	Normal	87%	
			200 x 1	Normal	87%	

5 Drawer Cabinets



Order Code	Model	Size (mm)	Drawer Configuration (mm)	Drawer Type	Drawer Opening	Price RM
TMTB30						
-10605A	No.1	564 x 573 x 700(h)	75 x 2	Normal	87%	3559.60
			100 x 1	Normal	87%	
			150 x 1	Normal	87%	
-10705A	No.2	564 x 573 x 800(h)	200 x 1	Normal	87%	3687.40
			50 x 1	Normal	87%	
			100 x 2	Normal	87%	
			150 x 1	Normal	87%	
			300 x 1	Normal	87%	

6 Drawer Cabinets



Order Code	Model	Size (mm)	Drawer Configuration (mm)	Drawer Type	Drawer Opening	Price RM
TMTB30						
-10905A	No.1	564 x 573 x 1000(h)	75 x 2	Normal	87%	4375.10
			100 x 1	Normal	87%	
			150 x 1	Normal	87%	
			200 x 1	Normal	87%	
-10755A	No.2	564 x 573 x 850(h)	75 x 1	Normal	87%	4139.30
			100 x 3	Normal	87%	
			125 x 1	Normal	87%	
			250 x 1	Normal	87%	

5 Drawer Wide Cabinets



Order Code	Model	Size (mm)	Drawer Configuration (mm)	Drawer Type	Drawer Opening	Price RM
TMTB30						
-40340A	No.1	1023 x 573 x 850(h)	100 x 3	Normal	87%	5911.40
			150 x 1	Normal	100%	
			300 x 1	Normal	100%	
-40345B	No.2	1023 x 573 x 850(h)	100 x 3	Normal	100%	6737.90
			150 x 1	Normal	100%	
			300 x 1	Normal	100%	

3-Shelf Retractable Cabinets



Order Code	Model	Size (mm)	Shelves Plate	Plate Type	Drawer Opening	Price RM
TMTB30						
-20581A	No.1	717 x 726 x 1450(h)	Upper Plate	Adjustable	Fixed	3954.10
			Middle Plate	Can pull out	87%	
			Base Plate	Can pull out	87%	
-20586B	No.2	717 x 726 x 1450(h)	Upper Plate	Adjustable	Fixed	4527.20
			Middle Plate	Can pull out	100%	
			Base Plate	Can pull out	100%	

Multiple Drawer Cabinets

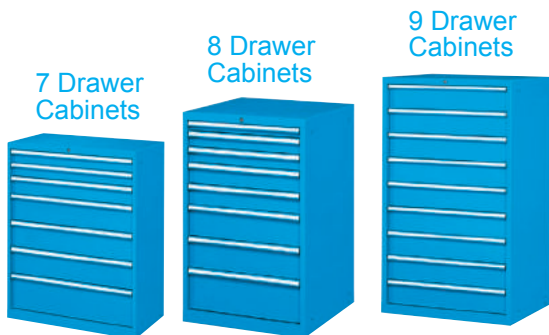

7 Drawer Cabinets

Order Code TMTB30	Model	Size (mm)	Drawer Configuration (mm)	Drawer Type	Drawer Opening	Price RM
-10340A	No.1	717 x 573 x 850(h)	50 x 1	Normal	87%	5613.80
			75 x 2	Normal	87%	
			100 x 2	Normal	87%	
			150 x 1	Normal	100%	
			200 x 1	Normal	100%	
-10345B	No.2	717 x 573 x 850(h)	50 x 1	Normal	87%	6680.60
			75 x 2	Normal	100%	
			100 x 2	Normal	100%	
			150 x 1	Normal	100%	
			200 x 1	Normal	100%	
-20340A	No.3	717 x 726 x 850(h)	50 x 1	Normal	87%	5794.50
			75 x 2	Normal	87%	
			100 x 2	Normal	87%	
			150 x 1	Normal	87%	
			200 x 1	Normal	87%	
-20345B	No.4	717 x 726 x 850(h)	50 x 1	Normal	87%	7659.20
			75 x 2	Normal	100%	
			100 x 2	Normal	100%	
			150 x 1	Normal	100%	
			200 x 1	Normal	100%	

8 Drawer Cabinets

Order Code TMTB30	Model	Size (mm)	Drawer Configuration (mm)	Drawer Type	Drawer Opening	Price RM
-10401A	No.1	717 x 573 x 1000(h)	50 x 1	Normal	87%	6277.20
			75 x 2	Normal	87%	
			100 x 3	Normal	87%	
			150 x 1	Normal	100%	
			250 x 1	Normal	100%	
-10406B	No.2	717 x 573 x 1000(h)	50 x 1	Normal	87%	7610.70
			75 x 2	Normal	100%	
			100 x 3	Normal	100%	
			150 x 1	Normal	100%	
			250 x 1	Normal	100%	
-20400A	No.3	717 x 726 x 1000(h)	50 x 1	Normal	87%	6929.60
			75 x 2	Normal	87%	
			100 x 2	Normal	87%	
			150 x 2	Normal	87%	
			200 x 1	Normal	100%	
-20405B	No.4	717 x 726 x 1000(h)	50 x 1	Normal	87%	8781.10
			75 x 2	Normal	100%	
			100 x 2	Normal	100%	
			150 x 2	Normal	100%	
			200 x 1	Normal	100%	

9 Drawer Cabinets

Order Code TMTB30	Model	Size (mm)	Drawer Configuration (mm)	Drawer Type	Drawer Opening	Price RM
-10580B	No.1	717 x 573 x 1450(h)	150 x 9	Tube	100%	9497.40

7 Drawer Wide Cabinets



Order Code TMTB30	Model	Size (mm)	Drawer Configuration (mm)	Drawer Type	Drawer Opening	Price RM
-40400A	No.1	1023 x 573 x 1000(h)	75 x 2	Normal	87%	7817.90
			100 x 1	Normal	87%	
			150 x 3	Tube	100%	
			200 x 1	Tube	100%	
-40405B	No.2	1023 x 573 x 1000(h)	75 x 2	Tube	100%	8644.40
			100 x 1	Tube	100%	
			150 x 3	Tube	100%	
			200 x 1	Tube	100%	

9 Drawer Wide Cabinets



Order Code TMTB30	Model	Size (mm)	Drawer Configuration (mm)	Drawer Type	Drawer Opening	Price RM
-40580A	No.1	1023 x 573 x 1450(h)	75 x 2	Normal	87%	10096.90
			100 x 2	Normal	87%	
			150 x 2	Normal	100%	
			200 x 2	Tube	100%	
-40585B	No.2	1023 x 573 x 1450(h)	300 x 1	Tube	100%	11198.90
			75 x 2	Tube	100%	
			100 x 2	Tube	100%	
			150 x 2	Tube	100%	
			200 x 2	Tube	100%	

Double Drawer Cabinets with Lower Buck Storage Areas



Order Code TMTB30	Model	Size (mm)	Drawer Configuration (mm)	Locker Configuration (mm)	Drawer Type	Drawer Opening	Price RM
-11605A	No.1	564 x 573 x 700(h)	75 x 2	425 (h) x 1	Normal x1 Adjustable x 1	87% -	2805.80
-11705A	No.2	564 x 573 x 800(h)	100 x 1 150 x 1	425 (h) x 1	Normal Adjustable x 1	87% -	2971.10

TEMO® Professional Heavy Duty Roller Cabinet Series
EXCELLENT

- Center locking system : Fully Imported
- Advanced technology prevents opening more than one drawer at a time.
- Release mechanism feature ensures that only one drawer will be open at a time- no other drawer can be opened.
- Fitted with high quality lock and 5 coded keys , key-aliqed , master key can be duplicated for top security.
- Lock compatible : below 1/2000
- Each drawer have an evenly distributed load capacity of 100kg for normal and 200kg for tube type drawer respectively.
- Ball bearing drawer slides with Heavy-duty load capacity create a smooth running action.
- One piece steel of cabinets body :3mm thickness plate.
- Multiple colour selections : (Blue, Green, Grey, Silver)
- **Can be customized according to customer requirements.**

4 Drawer Roller Cabinet

- Roller Cabinet Loading Capacity : 310kg
- Equipped with two directed and two-brake 100mm (4") rubber casters.
- Equipped with uptuned edges on four sdes 32mm Top Trays.
- Equipped with Internal oil-proof mats
- Fitted with handles for easy to control cabinets direction.



Order Code	Model	Size (mm)	Drawer Configuration (mm)	Drawer Type	Drawer Opening	Price RM
TMTB31			75 x 1	Normal	87%	
-55002A	No.1	564 x 613 x 777(h)	100 x 1 125 x 1 200 x 1	Normal Normal Normal	87% 87% 87%	3848.30

5 Drawer Roller Cabinet

- Roller Cabinet Loading Capacity : 310kg
- Equipped with two directed and two-brake 100mm (4") rubber casters.
- Equipped with uptuned edges on four sdes 32mm Top Trays.
- Equipped with Internal oil-proof mats
- Fitted with handles for easy to control cabinets direction.



Order Code	Model	Size (mm)	Drawer Configuration (mm)	Drawer Type	Drawer Opening	Price RM
TMTB31			75 x 2	Normal	87%	
-56001A	No.1	564 x 613 x 877(h)	100 x 1 150 x 1 200 x 1	Normal Normal Normal	87% 87% 87%	4415.90

4 Drawer Combination Roller Cabinet

- 4 Drawer Roller Cabinet with top pegboard.
- Equipped with two directed and two-brake 100mm (4") rubber casters.
- Equipped with uptuned edges on four sdes 32mm Top Trays.
- Equipped with Top Tray oil-proof mats
- Fitted with side handle for easy to control cabinets direction.



Order Code	Model	Size (mm)	Drawer Configuration (mm)	Drawer Type	Drawer Opening	Price RM
TMTB31			75 x 2	Normal	87%	
-23415A	No.1	717 x 726 x 1027/1727(h)	100 x 1 200 x 1 300 x 1	Normal Normal Adjustable	87% 87% -	6352.20

6 Drawer Roller Cabinet

- Roller Cabinet Loading Capacity : 310kg
- Equipped with two directed and two-brake 100mm (4") rubber casters.
- Equipped with uptuned edges on four sdes 32mm Top Trays.
- Equipped with Internal oil-proof mats
- Fitted with handles for easy to control cabinets direction.



Order Code	Model	Size (mm)	Drawer Configuration (mm)	Drawer Type	Drawer Opening	Price RM
TMTB31			75 x 2	Normal	87%	
-57002A	No.1	564 x 613 x 977(h)	100 x 2 150 x 1 200 x 1	Normal Normal Normal	87% 87% 87%	4972.40

6 Drawer Wide Roller Cabinets

- Roller Cabinet Loading Capacity : 600kg
- Equipped with two directed and two-brake 100mm (4") rubber casters.
- Equipped with uptuned edges on four sides 32mm Top Trays.
- Equipped with Internal oil-proof mats
- Fitted with handles for easy to control cabinets direction.



Order Code TMTB31	Model	Size (mm)	Drawer Configuration (mm)	Drawer Type	Drawer Opening	Price RM
-53405A	No.1	1098 x 727 x 1037(h)	75 x 2	Normal	87%	8042.70
			100 x 1	Normal	87%	
			150 x 2	Normal	100%	
			200 x 1	Normal	100%	
-53455B	No.2	1098 x 727 x 1037(h)	75 x 2	Tube	100%	9889.70
			100 x 1	Tube	100%	
			150 x 2	Tube	100%	
			200 x 1	Tube	100%	

7 Drawer Roller Cabinets

- Roller Cabinet Loading Capacity : 350kg
- Equipped with two directed and two-brake 100mm (4") rubber casters.
- Equipped with uptuned edges on four sides 32mm Top Trays.
- Equipped with Internal oil-proof mats
- Fitted with handles for easy to control cabinets direction.



Order Code TMTB31	Model	Size (mm)	Drawer Configuration (mm)	Drawer Type	Drawer Opening	Price RM
-13401A	No.1	717 x 574 x 1027(h)	50 x 1	Normal	87%	6578.10
			75 x 2	Normal	87%	
			100 x 2	Normal	87%	
			150 x 1	Tube	100%	
			200 x 1	Tube	100%	
-13451B	No.2	717 x 574 x 1027(h)	50 x 1	Normal	87%	7644.90
			75 x 2	Tube	100%	
			100 x 2	Tube	100%	
			150 x 1	Tube	100%	
			200 x 1	Tube	100%	
-23401A	No.3	717 x 802 x 1027(h)	50 x 1	Normal	87%	6824.90
			75 x 2	Normal	87%	
			100 x 2	Normal	87%	
			150 x 1	Normal	87%	
			200 x 1	Normal	87%	
-23451B	No.4	717 x 802 x 1027(h)	50 x 1	Normal	87%	8689.60
			75 x 2	Tube	100%	
			100 x 2	Tube	100%	
			150 x 1	Tube	100%	
			200 x 1	Tube	100%	

7 Drawer Wide Roller Cabinets

- Roller Cabinet Loading Capacity : 600kg
- Equipped with two directed and two-brake 100mm (4") rubber casters.
- Equipped with uptuned edges on four sides 32mm Top Trays.
- Equipped with Internal oil-proof mats
- Fitted with handles for easy to control cabinets direction.



Order Code TMTB31	Model	Size (mm)	Drawer Configuration (mm)	Drawer Type	Drawer Opening	Price RM
-54002A	No.1	1098 x 727 x 1187(h)	75 x 2	Normal	87%	10306.30
			100 x 1	Normal	87%	
			150 x 3	Tube	100%	
			200 x 1	Tube	100%	
-54052B	No.2	1098 x 727 x 1187(h)	75 x 2	Tube	100%	11232.00
			100 x 1	Tube	100%	
			150 x 3	Tube	100%	
			200 x 1	Tube	100%	
-74002B	No.3	1506 x 727 x 1187(h)	75 x 2	Tube	100%	13392.00
			100 x 1	Tube	100%	
			150 x 3	Tube	100%	
			200 x 1	Tube	100%	

Waterproof Plastic Cases **IP67**

- Widely used to store instruments, instruments, portable devices, and tools
- Mainly used in fire fighting, military, field photography and other fields
- Box formed by high impact engineering plastic injection molding
- Dust-proof, waterproof, anti-corrosion, can effectively protect equipment in harsh environments
- Sealing buckle, single injection molded part, impact resistant
- Anti-static foam, pre-cut into a grid-like, user-friendly combination
- The front of the box has a knob with a ring, used to manually adjust the pressure inside the box
- Padlock hole
- Box size in line with aviation, train carrying rules



Order Code	length (mm)	width (mm)	height (mm)	Price RM
TMTB05				
-01010A	277	228	99	368.30
-01020A	277	228	153	447.50
-01030A	372	267	135	769.20
-01040A	387	289	104	607.60
-01050A	456	355	133	965.70
-01060A	415	319	168	769.20
-01070A	456	372	185	1287.40
-01080A	515	435	199	1836.80
-01090A	670	500	210	2115.60



Small Waterproof Plastic Case

Order Code	length (mm)	width (mm)	height (mm)	weight (kg)	Price RM
TMTB05					
-01001A	239	144	70	0.35	104.60

Waterproof Plastic Trolley Case **IP67**

- Widely used to store instruments, instruments, portable devices, and tools
- Mainly used in fire fighting, military, field photography and other fields
- Box formed by high impact engineering plastic injection molding
- Dust-proof, waterproof, anti-corrosion, can effectively protect equipment in harsh environments
- Anti-static foam, pre-cut into a grid-like, user-friendly combination
- The front of the box has a knob with a ring, used to manually adjust the pressure inside the box
- Sealing buckle, single injection molded part, impact resistant
- Padlock hole
- Wide lever, comfortable grip, durable
- Size: 720 x 470 x 260 mm



Order Code **TMTB05-02010B** Price RM **3058.50**

High Volume Impact Resistant HDPE Plastic Tool Case

- HDPE high-strength plastic box, aluminum frame, durable
- Unique box arc design, beautiful and stylish
- 3-digit password lock
- high-quality support rod and hinge
- The interior can be divided freely to meet different storage requirements
- Shoulder strap included
- Internal dimensions: 480 x 360 x 195 mm
- Volume: 35L
- Weight: 6kgs
- Maximum load: 30kgs
- Tools not included



Order Code **TMTB06-01010A** Price RM **2162.30**

Heavy Duty ABS Tool Case

- ABS high-strength plastic box, aluminum frame, durable
- Unique box rib design
- 3-digit password lock
- High-quality support rod and hinge
- The interior can be divided freely to meet different storage requirements
- With shoulder strap
- Inner dimensions: 445 x 350 x 170 mm
- Volume: 26L
- Weight: 5.5kgs
- Maximum load: 20kgs
- Tools not included



Order Code **TMTB06-02010A** Price RM **1491.00**

Classic Impact Resistant Electrician's Plastic Tool Case

- ABS high-strength plastic box, aluminum frame, durable
- Classic box design, the best choice for professionals
- 3-digit password lock
- High-quality support rod and hinge
- The interior can be divided freely to meet different storage requirements
- Internal dimensions: 470 x 360 x 160 mm
- Volume: 26L
- Weight: 4kgs
- Maximum load: 25kgs
- Tools not included



Order Code **TMTB06-03010A** Price RM 1531.80

High Volume Impact Resistant Engineer's Tool Case

- ABS high-strength plastic box, aluminum frame, durable
- Unique box-enhanced corner design
- 3-digit password lock
- High-quality support rod and hinge
- The interior can be divided freely to meet different storage requirements
- Internal dimensions: 480 x 370 x 180 mm
- Volume: 32L
- Weight: 6kgs
- Maximum load: 30kgs
- Tools not included



Order Code **TMTB06-04010A** Price RM 1620.00

Classic Impact Resistant Service Engineer's Trolley Case

- ABS high-strength plastic box, aluminum frame, durable
- Classic box design, the best choice for professionals
- 3-digit password lock
- High-quality support rod and hinge
- The interior can be divided freely to meet different storage requirements
- Inner dimensions: 485 x 350 x 195 mm
- Volume: 36L
- Weight: 8kgs
- Maximum load: 30kgs
- Tools not included

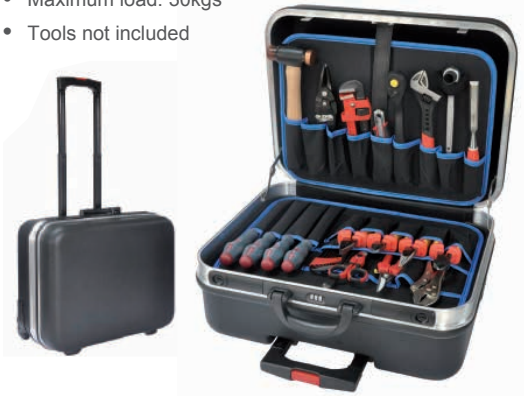

Order Code **TMTB06-05010B** Price RM 2218.70

High Volume High Impact Resistant Service Engineer's Trolley Case

- HDPE high-strength plastic box, aluminum frame, durable
- Unique box arc design, beautiful and stylish
- 3-digit password lock
- High-quality support rod and hinge
- The interior can be divided freely to meet different storage requirements
- Inner dimensions: 485 x 375 x 230 mm
- Volume: 46L
- Weight: 7.9kgs
- Maximum load: 35kgs
- Tools not included



Order Code **TMTB06-06010B** Price RM 549.70

Split Leather Pliers/Tool Holsters & Waist Belt

- Manufactured from heavy-duty split leather . Fully riveted for extra strength.
- For optimum organisation of tools.

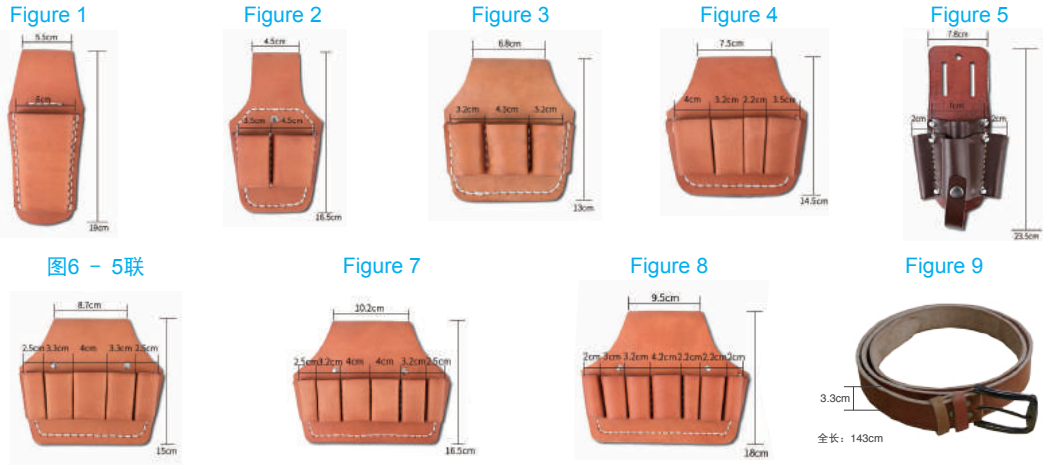

Order Code	Descriptions	Size W x H (cm)	Weight (g)	Picture	Price RM
TMTB59					
-00101A	Extended length	6 x 19	88	1	37.90
-00102A	Double Pockets	(3.5 + 4.5) x 16.5	64	2	36.60
-00103A	Triple Pockets	(3.2 + 4.3 + 3.2) x 16.5	96	3	37.90
-00104A	Four Pockets	(4 + 3.2 + 2.2 + 3.5) x 14.5	116	4	40.70
-00204A	Combination 4 Pockets	(2 + 7 + 7 + 2) x 23.5	124	5	65.40
-00105A	Five Pockets	(2.5 + 3.3 + 4 + 3.3 + 2.5) x 15	126	6	43.40
-00106A	Six Pockets	(2.5 + 3.2 + 4 + 4 + 3.2 + 2.5) x 16.5	168	7	53.00
-00107A	Seven Pockets	(2 + 3 + 3.2 + 4.2 + 2.2 + 2.2 + 2) x 18	206	8	59.80
-00501B	Leather Belt	3.3 x 143 (Width x Length)	226	9	51.70

Extra Heavy Duty Oxford Cloth Multi-usage Tool Bag

- Manufactured from 600D double-layer Oxford fabric that exceptionally durable and hard wearing, rigid waterproof rubber base for added durability , keep tools clean, dry and organized.
- 3 external pockets , 11 internal pockets for optimum organisational of tools.
- Padded carry handles for comfortable use.
- Capacity : 80kg
- Colour : Blue Black



Order Code	Size	Size (cm) (W x H x T)	Pockets / Loops pocket	Capacity (kg)	Price RM
TMTB59					
-30008D	17"	42 x 26 x 23	3(External) + 11 (Internal)	80	91.10

Oxford Cloth Multi-usage Maintenance Tool Bag

- Manufactured from 600D double-layer Oxford fabric that exceptionally durable and hard wearing, rigid waterproof rubber base for added durability , keep tools clean, dry and organized.
- 6 external pockets , 10 internal pockets for optimum organisational of tools.
- Padded carry handles for comfortable use.
- Capacity : 30kg
- The preferred tools bag for lifts maintenance , machine installations , construction sites , oil and gas and other heavy-duty operations.
- Colour : Blue Black



Order Code	Size	Size (cm) (W x H x T)	Pockets / Loops pocket	Capacity (kg)	Price RM
TMTB59					
-30001D	16"	39 x 28 x 25	6(External) + 10 (Internal)	30	91.10

Heavy Duty Oxford Cloth Electricians' Tool Bag

- Manufactured from 600D double-layer Oxford fabric that exceptionally durable and hard wearing, rigid waterproof rubber base for added durability , keep tools clean, dry and organized.
- 5 external loops pockets , 1 internal loops pockets for optimum organisational of tools.
- Adjustable shoulder straps for comfortable use.
- Capacity : 30kg
- The preferred tools bag for every eletricians , engineers and other heavy-duty operations.
- Colour : Blue Black



Order Code	Size	Size (cm) (W x H x T)	Pockets / Loops pocket	Capacity (kg)	Price RM
TMTB59					
-30004A	14"	39 x 28 x 11.5	5(External) + 1 (Internal)	30	43.40

Heavy Duty Maintenance Worker & Electricians' Waist Tool Pouch

- Manufactured from 600D double-layer Oxford fabric that exceptionally durable and hard wearing, resistance to punctures of tear. Heavily stitched webbing on belt loop and edges.
- 1 Pocket , multiple loops and velcro tape pockets allows optimum organisation of tools.
- Suitable for Working at height, eletricians use.
- Capacity : 30kg
- Colour : Blue Black



Order Code	Size (cm) (W x H x T)	Pockets / Loops pocket	Capacity (kg)	Price RM
TMTB59				
-30002B	56 x 16 x 5	1 + 7	30	52.50

Heavy Duty Multi-loops Electricians' Waist Tool Pouch

- Manufactured from 600D double-layer Oxford fabric that exceptionally durable and hard wearing, resistance to punctures of tear. Heavily stitched webbing on belt loop and edges.
- Multiple loops allows optimum organisation of tools.
- Suitable for Working at height.
- Capacity : 30kg
- Colour : Blue Black



Order Code	Size (cm) (W x H x T)	Pockets / Loops pocket	Capacity (kg)	Price RM
TMTB59				
-30004B	56 x 16 x 5	1 + 9	30	52.50

Heavy Duty Oxford Cloth Waist Pouch with Drill Holster and Tool Loops

- Manufactured from 600D double-layer Oxford fabric that exceptionally durable and hard wearing, resistance to punctures of tear. Heavily stitched webbing on belt loop and edges.
- 1 Drill machines pocket , multiple loops and velcro tape pockets allows optimum organisation of tools.
- Velcro tape will holds machine tools firmly
- Suitable for Working at height, eletricians use.
- Capacity : 30kg
- Colour : Blue Black



Order Code	Size (cm) (W x H x T)	Pockets / Loops pocket	Capacity (kg)	Price RM
TMTB59				
-30007B	56 x 16 x 5	1 + 4	30	52.50

Heavy Duty Multi-usage Maintenance Waist Tool Pouch

- Manufactured from 600D double-layer Oxford fabric that exceptionally durable and hard wearing.
- 2 external pockets + 2 side pockets and multiple loops pockets for optimum organisational of tools.
- Suitable for Working at height, electricians use.
- Capacity : 20kg
- Colour : Blue Black



Order Code	Size (cm) (W x H x T)	Pockets / Loops pocket	Capacity (kg)	Price RM
TMTB59				
-30001B	22 x 23 x 13	3 + 5	20	53.80

Oxford Cloth Electricians' Waist Tool Pouch

- Manufactured from 600D double-layer Oxford fabric that exceptionally durable and hard wearing.
- Multiples buckle for added strength and support.
- 5 loops pockets allows optimum organisational of tools.
- Suitable for Working at height, electricians use.
- Capacity : 20kg
- Colour : Blue Black



Order Code	Size (cm) (W x H x T)	Loops pocket	Capacity (kg)	Price RM
TMTB59				
-30003B	23 x 22 x 3	5	20	43.40

Heavy Duty Electricians' Tool Pouch with Big Pockets

- Manufactured from 600D double-layer Oxford fabric that exceptionally durable and hard wearing.
- Multiple large pockets allows optimum organisational of tools.
- Suitable for Working at height, electricians use.
- Capacity : 30kg
- Colour : Blue Black



Order Code	Size (cm) (W x H x T)	Pockets / Loops pocket	Capacity (kg)	Price RM
TMTB59				
-30005B	28 x 22 x 15	3 + 9	30	62.80

Oxford Cloth Multi-usage Drill Holster

- Manufactured from 600D double-layer Oxford fabric that exceptionally durable and hard wearing.
- Multiples buckle for added strength and support.
- Velcro tape will holds machine tools firmly
- Multiples loops pockets allows optimum organisational of tools.
- Suitable for Working at height, electricians use.
- Capacity : 15kg
- Colour : Blue Black



Order Code	Size (cm) (W x H x T)	Pockets / Loops pocket	Capacity (kg)	Price RM
TMTB59				
-30006B	15 x 25 x 3	6	15	33.90

Oxford Cloth Multi-loops Maintenance Workers' Tool Pouch

- Manufactured from 600D double-layer Oxford fabric that exceptionally durable and hard wearing.
- Multiple loops pockets allows optimum organisational of tools.
- Suitable for Working at height, electricians use.
- Capacity : 20kg
- Colour : Blue Black



Order Code	Size (cm) (W x H x T)	Pockets / Loops pocket	Capacity (kg)	Price RM
TMTB59				
-30008B	15 x 20 x 8	1 + 4	20	40.90

Super Magnetic Wristband

- Manufactured from 600D double-layer Oxford fabric that exceptionally durable and hard wearing.
- Super strong magnetic wristband for added strength and support.
- Suitable for Working at height, electricians use.
- Colour : Blue Black



Order Code	Size (cm) (W x H x T)	Price RM
TMTB59		
-31000C	38 x 9 x 0.4	32.60

**Professional Torque Wrenches -
Torque Setting Window Type**

- Widely used in various industrial fields and auto repair industries
- Numerical window design, easy to read and set
- Fewer teeth, can reduce ratchet head wear and prolong service lifespan
- Torque limit sound alarm
- Accuracy: ± 4%



Order Code	Square Drive (inch)	Torque range Metric (Nm)	No. of teeth	Total length (mm)	Weight (kg)	Price RM
TMTQ10						
-10010W	1/4"	3 - 15	20	193	0.21	598.40
-10020W	1/4"	6 - 30	20	300	0.59	656.40
-20010W	3/8"	12 - 60	30	390	0.75	728.60
-20020W	3/8"	20 - 100	30	425	0.88	762.30
-30010W	1/2"	40 - 200	32	530	1.62	805.70
-30020W	1/2"	60 - 320	32	600	1.83	983.80

**Professional Torque Wrenches -
Torque Setting Window Type**

- Widely used in various industrial fields and auto repair industries
- Numerical plate design, easy to read and set
- Fewer teeth, can reduce ratchet head wear and prolong service lifespan
- Metric and Imperial readings
- Torque limit sound alarm
- Accuracy: ± 4%



Order Code	Square Drive (inch)	Torque range Metric (Nm)	Imperial (lbf.ft)	No. of teeth	Total length (mm)	Weight (kg)	Price RM
TMTQ11							
-10010D	1/4"	6 - 30	4.43 - 22.14	24	350	0.74	412.20
-20010D	3/8"	20 - 110	15.00 - 81.18	24	385	0.96	458.80
-30010D	1/2"	40 - 210	29.52 - 154.98	24	535	1.7	564.70
-30020D	1/2"	70 - 350	51.66 - 258.30	24	645	2.54	753.50
-40010D	3/4"	100 - 500	73.80 - 369.00	24	865	3.66	1249.80
-40020D	3/4"	140 - 700	103.32 - 516.60	24	1092	5.94	3331.30
-40030D	3/4"	140 - 980	103.32 - 723.24	24	1230	6.46	3454.20
-50010D	1"	300 - 1500	221.40 - 1107.00	24	1700	11.58	5986.30

11Pc Professional Torque Wrench Kits

- Widely used in various industrial fields and auto repair industries



3/8 " Dr Set

Professional-grade digital torque wrench: 20 - 110N.m
Socket: 10, 12, 14, 17, 19, 21 mm
Hexagon Socket Bits: 4, 5, 6, 8mm

Order Code	Size	Price RM
TMTQ17		
-20011D	3/8"	564.90
-30011D	1/2"	733.30

1/2 " Dr Set

Professional grade disc torque wrench: 40 - 210N.m
Socket: 17, 19, 21, 22, 24, 27 mm
Hexagon Socket Bits: 6, 8, 10, 12mm

6Pc Professional Torque Wrench Kit

- Suitable for automobile tire repair and other industries



1/2 " Dr Set

Professional grade disc torque wrench: 40 - 210N.m
Extension bar: 250mm
75mm deep socket: 17mm, 19mm, 21mm
Cross socket bit: No.2

Order Code	Size	Price RM
TMTQ18		
-30006D	1/2"	767.20

Heavy Duty Bi-manual Ratchet Wrench Kit

- Unique design, two-handed operation, convenient and labor-saving, higher torque
- ratchet head teeth: 30, fewer teeth with greater torque
- Deep socket sizes: 17, 19, 21mm



Order Code	Size	Price RM
TMWR10		
-30004T	1/2"	380.50

Torque Multipliers

- Suitable for all kinds of industrial fields, such as aviation, shipbuilding and automobile manufacturing
- Suitable for all kinds of energy fields, such as power plants, oil fields, refineries and so on
- Applicable for all kinds of engineering construction, such as bridges, railways, garage work and so on
- Not for use with pneumatic tools, do not exceed force limit

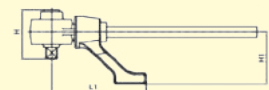

Thin head

Order Code	Type	Input	Output	Ratio	Maximum output torque		Accuracy	W (mm)	H (mm)	H1 (mm)	L (mm)	L1 (mm)	Price RM
					Metric (Nm)	Imperial (lbf.ft)							
-31001M	Thin head	1/2"	3/4"	1:3	1500	1100	±6%	73	84	90	420	157	2888.70
-41001M	Thin head	3/4"	1"	1:3	3000	2200	±6%	92	104	120	500	206	3291.50

Phosphate Adjustable Wrenches

- In line with the world's highest industrial standards
- High quality drop forged chrome vanadium steel
- Hot forged handle and jaws
- overall heat treatment
- Wide jaw adjustment range, beyond the ISO international standards
- Thick handle
- Jaw with graduated mm scale
- Phosphated anti-corrosion finish, better rust resistant
- Precision gear components, ensure jaw operation is extremely smooth
- When in use, the jaw tail does not protrude, more suitable for use in a small space



Order Code	Size	Capacity	Price RM
TMWR25			
-00150A	6" / 150mm	23.9mm	89.60
-00200A	8" / 200mm	28.6mm	110.60
-00250A	10" / 250mm	32.8mm	137.00
-00300A	12" / 300mm	38.0mm	170.30

Industrial Spanners

- Made of high quality chrome vanadium steel
- Sanded-silver surface treatment
- In accordance with the German DIN311 standard

Double Open Ended Spanners

Single piece

Order Code	Size (mm)	Price RM	Order Code	Size (mm)	Price RM
TMSP01			TMSP01		
-10010A	6 × 7	18.00	-10150A	18 × 19	44.00
-10030A	8 × 9	19.30	-10190A	20 × 22	55.30
-10050A	10 × 11	21.40	-10200A	21 × 23	60.70
-10080A	12 × 13	26.00	-10210A	22 × 24	60.70
-10110A	14 × 15	30.50	-10230A	24 × 27	73.70
-10130A	16 × 17	38.60	-10250A	25 × 28	81.80
-10140A	17 × 19	20.10	-10280A	30 × 32	98.90



6 Piece set	Order Code TMSP01-80106M	Price/RM 170.00
6 × 7mm, 8 × 9mm, 10 × 11mm 12 × 13mm, 14 × 15mm, 16 × 17mm		
8 Piece set	Order Code TMSP01-80208M	Price/RM 336.50
8 × 9mm, 10 × 11mm, 12 × 13mm 14 × 15mm, 16 × 17mm, 18 × 19mm 20 × 22mm, 22 × 24mm		
12 Piece set	Order Code TMSP01-80312M	Price/RM 593.80
6 × 7mm, 8 × 9mm, 10 × 11mm 12 × 13mm, 14 × 15mm, 16 × 17mm 18 × 19mm, 20 × 22mm, 21 × 23mm 24 × 27mm, 25 × 28mm, 30 × 32mm		

Combination Spanners

Single piece

Order Code	Size (mm)	Price RM	Order Code	Size (mm)	Price RM
TMSP02			TMSP02		
-10006A	6	15.80	-10017A	17	38.10
-10007A	7	16.80	-10018A	18	43.20
-10008A	8	17.60	-10019A	19	45.20
-10009A	9	19.40	-10020A	20	53.50
-10010A	10	20.20	-10021A	21	56.60
-10011A	11	21.70	-10022A	22	58.90
-10012A	12	24.60	-10023A	23	61.60
-10013A	13	27.60	-10024A	24	62.30
-10014A	14	29.40	-10027A	27	80.10
-10015A	15	30.80	-10030A	30	97.30
-10016A	16	33.40	-10032A	32	107.20



6 Piece set	Order Code TMSP02-80106M	Price/RM 164.50
6 mm, 8 mm, 10 mm 12mm, 14 mm, 17mm		
8 Piece set	Order Code TMSP02-80208M	Price/RM 275.50
6 mm, 8 mm, 10 mm 12mm, 14 mm, 17mm, 19mm, 22mm		
12 Piece set	Order Code TMSP02-80312M	Price/RM 627.60
6 mm, 8 mm, 10 mm 12mm, 14 mm, 17mm, 19mm, 22mm 24mm, 27mm, 30mm, 32mm		

Industrial Double Ended Ring Spanners

Single piece

Order Code	Size (mm)	Price RM	Order Code	Size (mm)	Price RM
TMSP03			TMSP03		
-10015A	6 × 7	30.10	-10095A	18 × 19	71.90
-10025A	8 × 9	32.70	-10135A	20 × 22	86.10
-10035A	8 × 10	35.50	-10145A	21 × 23	105.70
-10045A	10 × 11	37.10	-10155A	22 × 24	110.60
-10065A	12 × 13	43.80	-10185A	24 × 27	113.50
-10075A	14 × 15	49.70	-10205A	25 × 28	121.80
-10085A	16 × 17	58.50	-10245A	30 × 32	140.00
-10090A	17 × 19	66.80			



6 Piece set	Order Code TMSP03-80106M	Price/RM 304.90
6 × 7mm, 8 × 9mm, 10 × 11mm 12 × 13mm, 14 × 15mm, 16 × 17mm		
8 Piece set	Order Code TMSP03-80208M	Price/RM 581.30
8 × 9mm, 10 × 11mm, 12 × 13mm 14 × 15mm, 16 × 17mm, 18 × 19mm 20 × 22mm, 22 × 24mm		
12 Piece set	Order Code TMSP03-80312M	Price/RM 1057.20
6 × 7mm, 8 × 9mm, 10 × 11mm 12 × 13mm, 14 × 15mm, 16 × 17mm 18 × 19mm, 20 × 22mm, 21 × 23mm 24 × 27mm, 25 × 28mm, 30 × 32mm		

Industrial Hex Sockets

- Made of high quality chrome vanadium steel
- Electrum + knurling, non-slip



Dr. size 1/4"

Order Code TMSK10	Size (mm)	Total length (mm)	Weight (g)	Price RM
-10004A	4.0	25.0	10.0	10.30
-10005A	5.0	25.0	10.0	10.30
-10006A	6.0	25.0	10.0	10.30
-10007A	7.0	25.0	10.0	10.30
-10008A	8.0	25.0	15.0	10.50
-10009A	9.0	25.0	15.0	10.50
-10010A	10.0	25.0	15.0	10.80
-10011A	11.0	25.0	20.0	10.50
-10012A	12.0	25.0	25.0	11.10
-10013A	13.0	25.0	25.0	11.50
-10014A	14.0	25.0	25.0	11.70

Dr. size 3/8"

Order Code TMSK10	Size (mm)	Total length (mm)	Weight (g)	Price RM
-20006A	6.0	28.0	25.0	11.50
-20007A	7.0	28.0	25.0	11.50
-20008A	8.0	28.0	25.0	11.00
-20009A	9.0	28.0	25.0	11.20
-20010A	10.0	28.0	25.0	11.20
-20011A	11.0	28.0	25.0	11.20
-20012A	12.0	28.0	25.0	11.50
-20013A	13.0	28.0	25.0	11.70
-20014A	14.0	28.0	30.0	12.00
-20015A	15.0	28.0	40.0	12.30
-20016A	16.0	28.0	35.0	12.30
-20017A	17.0	30.0	50.0	13.10
-20018A	18.0	30.0	60.0	13.90
-20019A	19.0	30.0	60.0	14.70
-20020A	20.0	30.0	75.0	17.00
-20021A	21.0	30.0	70.0	17.00
-20022A	22.0	30.0	80.0	18.50

Dr. size 1/2"

Order Code TMSK10	Size (mm)	Total length (mm)	Weight (g)	Price RM
-30008A	8.0	38.0	50.0	14.70
-30009A	9.0	38.0	50.0	14.70
-30010A	10.0	38.0	55.0	13.90
-30011A	11.0	38.0	55.0	13.90
-30012A	12.0	38.0	55.0	13.90
-30013A	13.0	38.0	60.0	13.90
-30014A	14.0	38.0	55.0	13.90
-30015A	15.0	38.0	55.0	13.90
-30016A	16.0	38.0	60.0	13.90
-30017A	17.0	38.0	65.0	16.20
-30018A	18.0	38.0	85.0	18.20
-30019A	19.0	38.0	75.0	18.20
-30020A	20.0	38.0	90.0	19.30
-30021A	21.0	38.0	85.0	19.30
-30022A	22.0	38.0	100.0	22.20
-30023A	23.0	38.0	120.0	25.20
-30024A	24.0	38.0	110.0	25.20
-30025A	25.0	42.0	135.0	29.20
-30026A	26.0	42.0	160.0	33.20
-30027A	27.0	42.0	160.0	33.20
-30028A	28.0	42.0	180.0	38.70
-30029A	29.0	42.0	170.0	40.30
-30030A	30.0	44.0	210.0	41.10
-30032A	32.0	44.0	225.0	44.20

Industrial Extension Bars

- Made of high quality chrome vanadium steel
- Electrum + knurling, non-slip



1/4" Dr.

Order Code TMSK30	Size (mm)	Weight (g)	Price RM
-10050E	50mm / 2"	20.0	12.70
-10100E	100mm / 4"	45.0	15.00
-10150E	150mm / 6"	65.0	17.70

3/8" Dr.

Order Code TMSK30	Size (mm)	Weight (g)	Price RM
-20075E	75mm / 3"	80.0	17.70
-20150E	150mm / 6"	140.0	25.70
-20250E	250mm / 10"	240.0	41.90

1/2" Dr.

Order Code TMSK30	Size (mm)	Weight (g)	Price RM
-30075E	75mm / 3"	145.0	28.10
-30125E	125mm / 5"	220.0	32.00
-30250E	250mm / 10"	430.0	55.30

Industrial T Sliding Handles

- Made of high quality chrome vanadium steel
- Electrum, non-slip



Order Code TMSK31	Square Drive	Total length (mm)	Weight (g)	Price RM
-10150E	1/4"	115.0	40.0	21.40
-20165E	3/8"	165.0	150.0	41.40
-30250E	1/2"	250.0	360.0	59.60

1/2" Dr. Industrial Full Steel Speed Bar

- Made of high quality chrome vanadium steel
- Electrum + knurling, non-slip



Order Code TMSK31	Square Drive	Total length (mm)	Weight (g)	Price RM
-30420S	1/2"	420mm / 16-1/2"	600.0	129.50

Drive Converters

- Made of high quality chrome vanadium steel
- Electrum, non-slip



1/4" Dr.

Order Code TMSK36	Square drive (female) X (male)	Total length (mm)	Weight (g)	Price RM
-11438A	1/4" x 3/8"	26.0	20.0	10.30
-23814A	3/8" x 1/4"	26.5	30.0	15.00

3/8" Dr.

Order Code TMSK36	Square drive (female) X (male)	Total length (mm)	Weight (g)	Price RM
-23814A	3/8" x 1/4"	26.5	30.0	12.70
-23812A	3/8" x 1/2"	36.5	50.0	37.90
-31238A	1/2" x 3/8"	36.5	50.0	24.00

1/2" Dr.

Order Code TMSK36	Square drive (female) X (male)	Total length (mm)	Weight (g)	Price RM
-23812A	3/8" x 1/2"	36.5	50.0	15.00
-31238A	1/2" x 3/8"	36.5	50.0	24.00
-31234A	1/2" x 3/4"	51.0	140.0	37.90
-43412A	3/4" x 1/2"	56.0	190.0	64.80

Industrial T Sliding Handles

- Made of high quality chrome vanadium steel
- Electrum, non-slip



Order Code TMSK36	Square Drive	Total length (mm)	Weight (g)	Price RM
-01414J	1/4"	34.5	20.0	23.30
-03838J	3/8"	36.0	25.0	32.40
-01212J	1/2"	39.5	30.0	46.60

72T Mirror Polish Finished Ratchet Combination Spanners

- Mirror polished, durable, rust resistant
- 72 teeth design is more suitable for use in small spaces

Fixed Heads



Flex Heads



Size (mm)	Fixed head		Flexi-head	
	Order Code TMSP07	Price RM	Order Code TMSP07	Price RM
6	-20060A	14.00	-30060A	18.60
7	-20070A	14.70	-30070A	19.20
8	-20080A	22.20	-30080A	24.40
9	-20090A	15.80	-30080A	21.20
10	-20100A	23.40	-30100A	27.40
11	-20110A	24.00	-30110A	28.90
12	-20120A	28.00	-30120A	32.00
13	-20130A	28.40	-30130A	32.40
14	-20140A	30.00	-30140A	36.80
15	-20150A	30.50	-30150A	36.90
16	-20160A	37.60	-30160A	45.80
17	-20170A	38.50	-30170A	45.80
18	-20180A	40.30	-30180A	49.70
19	-20190A	41.00	-30190A	49.70
20	-20200A	35.30	-30200A	51.00
21	-20210A	58.00	-30210A	64.90
22	-20220A	58.70	-30220A	65.00
23	-20230A	47.30	-30230A	58.70
24	-20240A	75.50	-30240A	73.60
25	-20250A	76.30	-30250A	74.50
27	-20270A	101.90	-30270A	108.90
30	-20300A	114.40	-30300A	128.90
32	-20320A	121.40	-30320A	143.30

Fixed Head Sets



Order Code TMSP07	No. of pieces	Size (mm)	Package	Price RM
-20012T	12	8, 9, 10, 11, 12, 13, 14, 15, 16, 17, 18, 19	Blow box	290.90
-20022T	22	6, 7, 8, 9, 10, 11, 12, 13, 14, 15, 16, 17, 18, 19, 20, 21, 22, 23, 24, 27, 30, 32	Aluminum box	859.60

14Pc 3/4" Dr. Heavy Duty Socket Set - Metric

- Made of high quality chrome vanadium steel
- 3/4 " Dr. ratchet handle: 500mm
- 3/4 " Dr. sliding T-handle: 500mm
- 2-piece 3/4 " Dr. extension bar: 200mm, 400mm
- 10-piece 3/4 " Dr. sockets: 22, 24, 27, 30, 32, 36, 38,41, 46, 50mm



Order Code	No. of pieces	Price RM
TMSK80		
-40214M	14	1667.70

12Pc 1" Dr. Heavy Duty Socket Set - Metric

- Made of high quality chrome vanadium steel
- 1 "Dr. ratchet handle: 500mm
- 1 "Dr. 3-ways adaptor
- 2-piece 1 "Dr. extension bar: 200mm, 400mm
- 8-piece 1 "Dr. sockets: 46, 50, 55, 60, 65, 70, 75, 80mm



Order Code	No. of pieces	Price RM
TMSK80		
-50212M	12	3333.70

TEMO[®] 72T Mirror Finish Ratchet Handles
EASYUSE

- Made of high quality chrome vanadium steel.
- New whale shape design, to meet more job requirements. careful and practical.
- Pole is mirror polished , corrosion and rust resistant, oiled, easy to clean.
- Ergonomic non-slip two-color plastic handle, comfortable grip.
- 72 teeth ratchet, for small work space.

Offset



Straight



Order Code	Model	Square Drive	Total Length (mm)	Weight (g)	Price RM
-12001A	Offset	1/4"	152	140	56.00
-22001A	Offset	3/8"	194	300	74.00
-32001A	Offset	1/2"	250	620	82.00
-12001B	Straight	1/4"	160	200	56.00
-22001B	Straight	3/8"	200	350	74.00
-32001B	Straight	1/2"	255	650	82.00

16Pc 1/4" Dr. Socket Set - Metric

- Made of high quality chrome vanadium steel
- 1/4 " Dr. 72 teeth ratchet handle: 140mm
- 1/4 " Dr. sliding T-handle: 115mm
- 1/4 " Dr. extension bar: 100mm
- 1/4 " Dr. spinner handle: 150mm
- 1/4 " Dr. universal joint
- 11-piece 1/4 " Dr. Sockets:
4, 4.5, 5, 5.5,
6, 7, 8, 9, 10,
11, 13mm



Order Code	No. of pieces	Price RM
TMSK80		
-10116M	16	272.50

14Pc 1/4" Dr. Socket Set - Inch

- Made of high quality chrome vanadium steel
- 1/4 " Dr. 72 teeth ratchet handle: 140mm
- 1/4 " Dr. sliding T-handle: 115mm
- 1/4 " Dr. extension bar: 100mm
- 1/4 " Dr. spinner handle: 150mm
- 1/4 " Dr. universal joint
- 9-piece 1/4 " Dr. sockets:
3/16", 7/32", 1/4",
9/32", 5/16",
11/32", 3/8",
7/16", 1/2"



Order Code	No. of pieces	Price RM
TMSK80		
-10114N	14	290.90

17Pc 3/8" Dr. Socket Set - Metric

- Made of high quality chrome vanadium steel
- 3/8 " Dr. 72 teeth ratchet handle: 200mm
- 3/8 " Dr. sliding T-handle: 165mm
- 2-piece 3/8 " Dr. extension bar: 125mm, 250mm
- 3/8 " Dr. universal joint
- 12-piece 3/8 " Dr. sockets:
6, 7, 8, 9, 10,
11, 13, 14, 15,
16, 17, 19mm



Order Code	No. of pieces	Price RM
TMSK80		
-20117M	17	373.30

26Pc 3/8" Dr. Socket Set - Metric

- Made of high quality chrome vanadium steel
- 3/8 " Dr. 72 teeth ratchet handle: 200mm
- 3/8 " Dr. sliding T-handle: 165mm
- 2-piece 3/8 " Dr. extension bar: 125mm, 250mm
- 8-piece socket bits:
⊙ Hexagon: 4, 5, 6, 8mm
⊖ Slot: 5.5, 8mm
⊕ Cross: PH2, PH3
- 3/8 " Dr. universal joint
- 13-piece 3/8 " Dr. socket: 6, 7,
8, 9, 10, 11, 12,
13, 14, 15, 16,
17, 19mm



Order Code	No. of pieces	Price RM
TMSK80		
-20126M	26	452.60

30Pc 1/2" Dr. Socket Set - Metric & Inch

- Made of high quality chrome vanadium steel
- 1/2 "Dr. 72 teeth ratchet handle: 255mm
- 22-piece 1/2 "Dr. sockets:
8, 9, 10, 11, 12, 13, 14, 15, 16, 17, 18, 19, 22, 24mm
3/8", 7/16", 1/2", 9/16", 5/8", 11/16", 3/4", 7/8"
- 2-piece 1/2 "Dr. spark plug sockets: M10, M14
- 1/2 "Dr. sliding T-handle: 250mm
- 3-piece 1/2 "Dr. extension bar: 75,
125, 250mm
- 1/2 "Dr. universal joint



Order Code	No. of pieces	Price RM
TMSK80		
-30130T	30	670.40

17Pc 1/2" Dr. Socket Set - Metric

- Made of high quality chrome vanadium steel
- 1/2 " Dr. 72 teeth ratchet handle: 255mm
- 1/2 " Dr. sliding T-handle: 250mm
- 1/2 " Dr. extension bar: 250mm
- 1/2 " Dr. universal joint
- 13-piece 1/2 " Dr. sockets:
10, 11, 12, 13,
14, 15, 17, 19,
22, 24, 27, 30,
32mm



Order Code	No. of pieces	Price RM
TMSK80		
-30117M	17	575.30

25Pc Engineer's Professional Tool Kit

- 26-liter heavy duty ABS plastic toolbox
- 1/2 "Dr. professional matte ratchet handle (260mm)
- 6 "/ 150mm industrial grade wire cutters
- 6 "/ 150mm industrial grade long-nose pliers
- 6 "/ 150mm industrial heavy-duty diagonal pliers
- Screwdrivers:
 - ⊖ Slot: 3 × 75mm, 6 × 38mm, 6 × 100mm, 8 × 150mm
 - ⊕ Cross: PH1 × 100mm, PH2 × 38mm, PH2 × 100mm, PH3 × 150mm
 - ☆ Star: T20 × 100mm, T25 × 100mm
- 9 pcs Metric extra long ball point L-wrench (1.5 - 10mm)
- 555mm flexible pick up tool with LED light



Order Code	No. of pieces	Price RM
TMTK10		
-01025A	25	2013.80

24Pc Electrician's Professional Tool Kit

- 35-liter high-capacity impact resistant plastic toolbox
- Automatic range digital multimeter
- 18 pieces of insulated electrical tools:
 - 7 "/ 180mm wire cutters, 8" / 200mm long-nose pliers, 6 "/ 150mm diagonal pliers
 - 8 pieces screwdriver set:
 - ⊖ Slot: 2.5 × 75mm, 3.0 × 100mm, 4.0 × 100mm, 5.5 × 125mm, 6.5 × 150mm, 8.5 × 175mm
 - ⊕ Cross: PH0 × 60mm, PH1 × 80mm
- Test pen: 120V / 250V, 2 rolls of insulation tape
- 2 pieces 8mm red square hole key handle, 2 pieces red triangle hole key handle
- 8 "/ 200mm insulated adjustable wrench
- 10 "/ 250mm insulated water pump pliers
- 140mm insulated electrician shears
- 8 "/ 200mm insulated electric knife (curved blade)



Order Code	No. of pieces	Price RM
TMTK10		
-03024N	24	3578.00

26Pc profesional Insulation Tool Kit

- 29-liter heavy duty ABS plastic toolbox
- Single end insulated ring spanners, 10,11,12,13,14,15,16,17,18 & 19mm
- Single end insulated open jaw spanners , 15,16,17,18 & 19mm
- Insulated screw driver
 - ⊖ Slot 4 x 100mm & 6 x100mm
 - ⊕ Cross PH1 x 100mm & PH2 x 125mm
- 8"/ 200mm Insulated adjustable wrench
- 8" /200mm Insulated diagonal pliers
- 10"/250mm Insulated water pump pliers
- 6"/150mm Insulated hack saw frame.
- 8"/200mm Insulated electrician's knife
- AC/DC Digital clamp meter



Order Code	No. of pieces	Price RM
TMTK10		
-05026N	26	4793.00

32Pc Heavy Duty Engineer's Tool Kit

- 32-liter high-capacity impact resistant plastic engineer's toolbox
- 150mm Industrial grade wire cutter
- 150mm Industrial grade long nose pliers
- 150mm Industrial grade diagonal nose pliers
- 150mm Industrial grade combination pliers
- 180mm Industrial grade locking pliers
- 200mm Industrial grade phosphate adjustable wrench.
- Industrial grade combination spanners , 11,13,15,16,17,18,19,20,22 &24mm
- 9Pc ball driver L-wrench set. (1.5 - 10mm)
- 1/2" Drive Mirror finish offset ratchet handle.
- 1/2" drive Hex socket ,8,10,13,15 & 17mm
- 1Lb wooden handle claw hammer.
- Industrial grade screwdrivers
 - ⊖ Slot . 5 x 150mm & 6 x 150mm
 - ⊕ Cross PH1 x 150mm & PH2 x 150mm
- 5m x 19mm measuring tape
- 50 x 80 x 575mm flexible pick up tool with LED light.



Order Code	No. of pieces	Price RM
TMTK10		
-06032A	32	2934.00

Impact Sockets

- Forged. Industrial quality
- Phosphate surface, anti-rust , non-slip
- Suitable for machine tools, such as pneumatic wrenches.

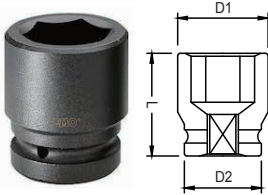

Dr. Size 1"

Order Code	Size (mm)	L (mm)	D1 (mm)	D2 (mm)	Price RM
TMSK40					
-30008C	8	38	14	24	21.30
-30009C	9	38	16	24	21.30
-30010C	10	38	16	24	21.30
-30011C	11	38	18	24	21.30
-30012C	12	38	19	24	21.30
-30013C	13	38	20	24	21.30
-30014C	14	38	22	24	21.30
-30015C	15	38	24	24	21.30
-30016C	16	38	25	25	21.30
-30017C	17	38	26	26	22.00
-30018C	18	38	27	27	26.30
-30019C	19	38	28	28	26.30
-30020C	20	38	30	30	29.20
-30021C	21	38	30	30	29.20
-30022C	22	38	32	30	31.00
-30023C	23	38	32	30	36.20
-30024C	24	42	35	30	36.20
-30025C	25	42	35	32	38.50
-30026C	26	42	36	32	38.50
-30027C	27	42	38	32	38.50
-30028C	28	42	40	32	47.50
-30029C	29	42	40	32	48.40
-30030C	30	42	42	32	52.20
-30031C	31	45	43	32	55.10
-30032C	32	45	44	32	59.20
-30034C	34	50	46	34	79.80
-30036C	36	50	50	34	88.10
-30038C	38	50	53	34	90.20
-50017C	17	80	34	50	60.80
-50018C	18	80	35	50	60.80
-50019C	19	80	36	50	60.80
-50020C	20	80	37	50	60.80
-50021C	21	80	38	50	60.80
-50022C	22	80	39	50	60.80
-50023C	23	80	40	50	60.80
-50024C	24	80	40	50	60.80
-50025C	25	80	41	50	60.80
-50026C	26	80	42.5	50	60.80
-50027C	27	80	44	50	60.80
-50028C	28	80	45	50	60.80
-50029C	29	80	46	50	60.80
-50030C	30	80	48	54	60.80
-50031C	31	80	51	54	60.80
-50032C	32	80	52	54	60.80
-50033C	33	80	53	54	60.80
-50034C	34	80	54	54	60.80
-50035C	35	80	55	54	60.80
-50036C	36	80	57	54	60.80
-50038C	38	80	59	54	60.80
-50041C	41	80	61	56	60.80
-50042C	42	90	63	56	67.40
-50046C	46	90	68	56	87.30
-50048C	48	90	70	56	93.10
-50050C	50	90	72	56	101.80
-50055C	55	90	78	56	117.70
-50060C	60	90	84	56	152.10
-50065C	65	100	89	65	191.80
-50070C	70	100	94	65	251.30
-50075C	75	100	104	65	290.90
-50080C	80	100	108	75	383.50
-50085C	85	103	114	75	476.10
-50090C	90	110	125	80	555.40
-50095C	95	110	129	80	634.80
-50100C	100	130	134	80	740.60
-50105C	105	135	139	80	846.40
-50110C	110	135	144	80	925.70
-50115C	115	135	149	90	1031.50
-50120C	120	135	158	90	1137.30

Dr. Size 1-1/2"

Order Code	Size (mm)	L (mm)	D1 (mm)	D2 (mm)	Price RM
TMSK40					
-60036C	36	90	58	74	158.70
-60038C	38	92	60	74	158.70
-60041C	41	95	64	74	158.70
-60046C	46	100	70	74	176.40
-60050C	50	100	74	74	194.10
-60055C	55	100	79	74	211.60
-60060C	60	100	90	80	227.50
-60065C	65	100	98	80	246.00
-60070C	70	100	102	80	264.50
-60075C	75	100	107	80	281.70
-60080C	80	100	114	84	317.40
-60085C	85	110	119	84	351.80
-60090C	90	110	128	90	387.50
-60095C	95	110	132	90	493.30
-60100C	100	115	136	90	599.10

Dr. Size 1/2"

Order Code	Size (mm)	L (mm)	D1 (mm)	D2 (mm)	Price RM
TMSK40					
-30008C	8	38	14	24	21.30
-30009C	9	38	16	24	21.30
-30010C	10	38	16	24	21.30
-30011C	11	38	18	24	21.30
-30012C	12	38	19	24	21.30
-30013C	13	38	20	24	21.30
-30014C	14	38	22	24	21.30
-30015C	15	38	24	24	21.30
-30016C	16	38	25	25	21.30
-30017C	17	38	26	26	22.00
-30018C	18	38	27	27	26.30
-30019C	19	38	28	28	26.30
-30020C	20	38	30	30	29.20
-30021C	21	38	30	30	29.20
-30022C	22	38	32	30	31.00
-30023C	23	38	32	30	36.20
-30024C	24	42	35	30	36.20
-30025C	25	42	35	32	38.50
-30026C	26	42	36	32	38.50
-30027C	27	42	38	32	38.50
-30028C	28	42	40	32	47.50
-30029C	29	42	40	32	48.40
-30030C	30	42	42	32	52.20
-30031C	31	45	43	32	55.10
-30032C	32	45	44	32	59.20
-30034C	34	50	46	34	79.80
-30036C	36	50	50	34	88.10
-30038C	38	50	53	34	90.20

Dr. Size 3/4"

Order Code	Size (mm)	L (mm)	D1 (mm)	D2 (mm)	Price RM
TMSK40					
-40017C	17	56	31	40	30.10
-40018C	18	56	32	40	30.10
-40019C	19	56	33	40	30.10
-40020C	20	56	34	40	30.10
-40021C	21	56	35	40	30.10
-40022C	22	56	36	40	30.10
-40023C	23	56	37	40	30.10
-40024C	24	56	38	40	30.10
-40026C	26	56	41	40	30.10
-40027C	27	56	42	40	30.10
-40028C	28	56	42	40	30.10
-40029C	29	56	43	40	30.10
-40030C	30	56	45	40	30.10

Dr. Size 3/4"

Order Code	Size (mm)	L (mm)	D1 (mm)	D2 (mm)	Price RM
TMSK40					
-40031C	31	56	46	42	30.10
-40032C	32	56	47	42	30.10
-40033C	33	56	48	42	30.10
-40034C	34	56	49	42	32.60
-40035C	35	56	51	43	32.60
-40036C	36	56	52	44	32.60
-40038C	38	56	54	44	32.60
-40041C	41	56	58	46	32.60
-40046C	46	60	65	48	68.90
-40050C	50	70	70	50	79.70
-40055C	55	80	78	50	94.20
-40060C	60	80	83	55	115.90
-40065C	65	100	88	55	137.80
-40070C	70	100	98	60	148.60

Impact Universal Joints

- Forged. Industrial quality
- Phosphate surface, anti-rust , non-slip
- Suitable for machine tools, such as pneumatic wrenches.



Order Code	Square drive (female) X (male)	Price RM
TMSK47		
-01212J	1/2" x 1/2"	76.70
-03434J	3/4" x 3/4"	108.40
-01010J	1" x 1"	168.70

Impact Drive Converters

- Forged. Industrial quality
- Phosphate surface, anti-rust , non-slip
- Suitable for machine tools, such as pneumatic wrenches.



Order Code	Square drive (female) X (male)	Price RM
TMSK46		
-31234C	1/2" x 3/4"	33.80
-43412C	3/4" x 1/2"	33.80
-43401C	3/4" x 1"	52.60
-51012C	1" x 1/2"	39.90
-51034C	1" x 3/4"	52.60
-51015C	1" x 1/1-2"	111.10
-61510C	1-1/2" x 1"	111.10

Impact Extension Bars

- Forged. Industrial quality
- Phosphate surface, anti-rust , non-slip
- Suitable for machine tools, such as pneumatic wrenches.



Order Code	Square drive	Length (mm)	Price RM
TMSK60			
-30075F	1/2"	75	20.00
-30125F	1/2"	125	23.00
-30250F	1/2"	250	29.10
-40100F	3/4"	100	54.30
-40150F	3/4"	150	61.60
-40200F	3/4"	200	76.20
-40300F	3/4"	300	94.20
-50100F	1"	100	58.00
-50150F	1"	150	65.20
-50200F	1"	200	79.70
-50300F	1"	300	101.50
-50400F	1"	400	112.40
-60200F	1-1/2"	200	490.90
-60300F	1-1/2"	300	736.40
-60400F	1-1/2"	400	981.80

Cr-Mo Sliding T Handles

- Forged. Industrial quality
- Phosphate surface, anti-rust , non-slip
- Suitable for machine tools, such as pneumatic wrenches.



Order Code	Square drive	Length (mm)	Price RM
TMSK61			
-30250F	1/2"	250	47.80
-40050F	3/4"	550	103.00
-50600F	1"	600	110.40

Black Finished Offset Handles

- Forged. Industrial quality
- Phosphate surface, anti-rust , non-slip
- Suitable for machine tools, such as pneumatic wrenches.

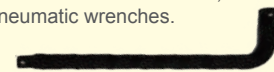

Order Code	Square drive	Length (mm)	Price RM
TMSK61			
-30250L	1/2"	250 x 50	36.80
-40400L	3/4"	400 x 100	81.00
-50400L	1"	400 x 200	136.20
-50500L	1"	500 x 100	154.60

Impact Hex Socket Bits

- Forged. Industrial quality
- Phosphate surface, anti-rust , non-slip
- Suitable for machine tools, such as pneumatic wrenches.

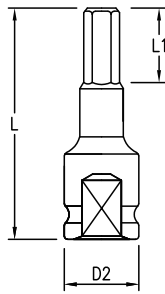

Dr. Size 1/2"

Order Code TMSK70	Size (mm)	L (mm)	L1 (mm)	D2 (mm)	Price RM
-30004C	4	78	13	24	33.10
-30005C	5	78	13	24	33.10
-30006C	6	78	13	24	33.10
-30007C	7	78	13	24	33.10
-30008C	8	78	15	24	33.10
-30009C	9	78	15	24	33.10
-30010C	10	78	15	24	33.10
-30011C	11	78	15	24	39.10
-30012C	12	78	15	28	39.10
-30013C	13	78	15	28	39.10
-30014C	14	78	15	28	39.10
-30015C	15	78	15	28	39.10
-30016C	16	78	15	28	39.10
-30017C	17	78	20	28	39.10
-30018C	18	78	20	28	39.10
-30019C	19	78	20	28	39.10
-30021C	21	78	20	32	40.40
-30022C	22	78	20	32	46.30

Dr. Size 3/4"

Order Code TMSK70	Size (mm)	L (mm)	L1 (mm)	D2 (mm)	Price RM
-40012C	12	100	30	44	64.80
-40014C	14	100	30	44	64.80
-40017C	17	100	30	44	64.80
-40019C	19	100	30	44	64.80
-40021C	21	100	30	44	64.80
-40022C	22	100	30	44	64.80
-40024C	24	100	30	44	64.80
-40027C	27	100	30	44	64.80
-40030C	30	100	30	44	64.80
-40032C	32	100	30	44	64.80

Dr. Size 1"

Order Code TMSK70	Size (mm)	L (mm)	L1 (mm)	D2 (mm)	Price RM
-50014C	14	100	30	54	116.40
-50017C	17	100	30	54	116.40
-50019C	19	100	30	54	116.40
-50021C	21	100	30	54	116.40
-50022C	22	100	30	54	116.40
-50024C	24	100	30	54	116.40
-50027C	27	100	30	54	116.40
-50030C	30	100	30	54	116.40
-50032C	32	100	30	54	116.40
-50036C	36	100	30	54	116.40

Dr. Size 1-1/2"

Order Code TMSK70	Size (mm)	L (mm)	L1 (mm)	D2 (mm)	Price RM
-60024C	24	100	30	76	279.00
-60027C	27	100	30	76	279.00
-60030C	30	100	30	76	279.00
-60032C	32	100	30	76	279.00
-60034C	34	100	30	76	279.00
-60036C	36	100	30	76	279.00
-60038C	38	100	30	76	279.00
-60041C	41	100	30	76	279.00
-60046C	46	100	30	76	279.00

Impact Torx Socket Bits

- Forged. Industrial quality
- Phosphate surface, anti-rust , non-slip
- Suitable for machine tools, such as pneumatic wrenches.

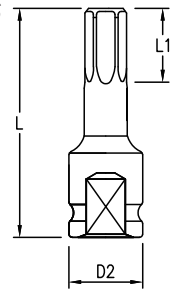

Dr. Size 1/2"

Order Code TMSK70	Size (mm)	L (mm)	L1 (mm)	D2 (mm)	Price RM
-30415C	T15	78	30	25	34.40
-30420C	T20	78	30	25	34.40
-30425C	T25	78	30	25	34.40
-30427C	T27	78	30	25	34.40
-30430C	T30	78	30	25	34.40
-30435C	T35	78	30	25	34.40
-30440C	T40	78	30	25	34.40
-30445C	T45	78	30	25	34.40
-30450C	T50	78	30	25	34.40
-30455C	T55	78	30	25	34.40
-30460C	T60	78	30	25	34.40
-30470C	T70	78	30	25	34.40
-30480C	T80	78	30	25	46.30
-30490C	T90	78	30	25	46.30

Impact Spline Socket Bits

- Forged. Industrial quality
- Phosphate surface, anti-rust , non-slip
- Suitable for machine tools, such as pneumatic wrenches.

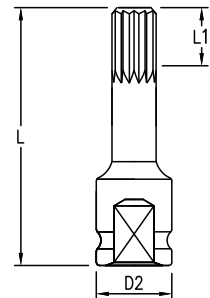

Dr. Size 1/2"

Order Code TMSK70	Size (mm)	L (mm)	L1 (mm)	D2 (mm)	Price RM
-30905C	5	78	7	24	34.40
-30906C	6	78	7	24	34.40
-30908C	8	78	9	24	34.40
-30909C	9	78	9	24	34.40
-30910C	10	78	9	24	34.40
-30912C	12	78	11	24	34.40
-30913C	13	78	11	24	34.40
-30914C	14	78	11	24	34.40
-30916C	16	78	13	24	46.30
-30918C	18	78	13	24	46.30

15Pc Metric Impact Socket Set (1/2" Dr.)

- 1/2" Drive x 38mm (L) Impact Sockets : 8,10,11,12,13,14,16,17,19,22,24,27,30 & 32mm.
- 1/2" 125mm Impact Extension Bars



Order Code	No. of pieces	Price RM
TMSK85	15	214.20
-30015M		

10Pc Metric Impact Socket Set (3/4" Dr.)

- 3/4" Drive x 56mm (L) Impact Sockets : 24,27,30 ,32, 33,34,36,38,41 & 46mm.



Order Code	No. of pieces	Price RM
TMSK85	10	404.30
-40010M		

21Pc Metric Impact Socket & Wrench Set (3/4" Dr.)

- 3/4" Drive x 56mm (L) Impact Sockets : 19,21,22,23,24,26,27,29,30 ,32, 33,34,36,38,41 & 46mm.
- 1 x 3/4" x 500mm Ratchet handle
- 1 x 3/4" x 100mm , 1 x 3/4" x 200mm Impact extension bars
- 1 x 3/4" x 500mm Sliding T handle
- 1x 3/4" Impact universal joint.



Order Code	No. of pieces	Price RM
TMSK85	21	1190.20
-41021T		

26Pc Metric & Imperial Impact Socket & Wrench Set (3/4" Dr.)

- 3/4" Drive x 56mm (L) Metric Impact Sockets : 22,24,27,30 ,32,36,38,41, 46 & 50mm.
- 3/4" Drive x 56mm (L) Imperial Impact Sockets : 7/8",15/16",1",1-1/8",1-3/16",1-5/16",1-3/8",1-7/16",1-5/8",1-3/4",1-7/8" & 2"
- 1 x 3/4" x 500mm Ratchet handle
- 1 x 3/4" x 100mm , 1 x 3/4" x 200mm Impact extension bars
- 1 x 3/4" x 500mm Sliding T handle



Order Code	No. of pieces	Price RM
TMSK85	26	1477.60
-40226T		

4Pc Metric Impact Socket Set (1" Dr.)

- 1" Drive x 78mm (L) Metric Impact Sockets : 22,27,38 & 41mm



Order Code	No. of pieces	Price RM
TMSK85	4	256.60
-50004M		

8Pc Metric Impact Socket Set (1" Dr.)

- 1" Drive x 78mm (L) Metric Impact Sockets : 22,24,27,30,32,36 38 & 41mm



Order Code	No. of pieces	Price RM
TMSK85	8	497.20
-50008M		

8Pc Impact Socket Bit Sets (1/2" Dr.)



Order Code	Size	Price RM
TMSK86		
-30008H	Hex : H5, H6, H8, H10, H12, H14, H17 & H19	246.00
-30108T	Torx :T30, T40, T45, T50, T55, T60, T70 & T80	246.00

26Pc Big Impact Socket Set - 3/4" & 1" Dr.

- Industrial quality forging
- Phosphated surface, anti-rust, non-slip
- Contains tools:
 - 3/4 " Dr. socket: 21, 22, 23, 24, 26, 27, 28, 29, 30, 31, 32, 34, 36, 38, 41, 46, 50mm
 - 1 " Dr. socket: 55, 60, 65mm
 - 3/4 " Dr. ratchet head: 150mm
 - 3/4 " Dr. extension bar: 200mm
 - 3/4 " Dr. sliding T-handle :500mm
 - 3/4"Dr. torque extension bar: 485mm
 - 3/4 "L-shaped extension bar: 190mm
 - 3/4 "(female) x 1" (male) converter



Order Code	No. of pieces	Weight (kg)	Price RM
TMSK85	26	20.4	1377.30
-40126T			

Industrial High Tensile Screwdrivers

- Handle made of high-strength chrome-molybdenum alloy steel, magnetic tips, strong and durable, anti-wear
- Phosphate blasted shaft, aesthetically pleasing and rust-resistant
- Ergonomic TPR soft plastic handle, comfortable and effortless in use
- Handle with hanging hole, more convenient tool storage, to avoid loss

Phillips Screwdrivers



Order Code	Size	Price RM
TMSC01		
-10003A	PH0 x 75mm	19.00
-11004A	PH1 x 100mm	23.30
-11006A	PH1 x 150mm	25.40

Order Code	Size	Price RM
TMSC01		
-12004A	PH2 x 100mm 加力杆	35.70
-12006A	PH2 x 150mm 加力杆	37.80
-12008A	PH2 x 200mm 加力杆	39.80
-13006A	PH3 x 150mm 加力杆	47.10

Slotted Screwdrivers



Order Code	Size	Price RM
TMSC02		
-10303A	3.2 x 75mm	17.70
-10404A	4.0 x 100mm	19.50
-10504A	5.0 x 100mm	23.30
-10506A	5.0 x 150mm	25.40

Order Code	Size	Price RM
TMSC02		
-10604A	6.0 x 100mm 加力杆	35.70
-10606A	6.0 x 150mm 加力杆	37.80
-10608A	6.0 x 200mm 加力杆	39.80
-10610A	6.0 x 250mm 加力杆	42.10
-10806A	8.0 x 150mm 加力杆	47.10
-10808A	8.0 x 200mm 加力杆	52.60

Industrial Screwdriver Sets in Plastic Boxes



Order Code	No. of pieces	Size	Price RM
TMSC88			
-30106T	6	⊕ PH1x100mm, PH1x150mm, PH2x100mm, PH2x150mm ⊖ 5.0x100mm, 5.0x150mm	399.80
-30206T	6	⊕ PH1x150mm, PH2x100mm ⊖ 4.0x100mm, 5.0x100mm, 5.0x150mm, 6.0x100mm	394.00
-30306T	6	⊕ PH0x75mm, PH1x100mm, PH1x150mm, PH2x100mm, PH2x150mm ⊖ 5.0x150mm	395.40
-30406T	6	⊖ 3.2x75mm, 4.0x100mm, 5.0x100mm, 5.0x150mm, 6.0x100mm ⊖ 6.0x150mm	388.50
-30107T	7	⊕ PH0x75mm, PH1x100mm, PH1x150mm, PH2x150mm ⊖ 3.2x75mm, 4.0x100mm, 6.0x100mm	407.30
-30207T	7	⊕ PH1x150mm, PH2x100mm, PH2x150mm ⊖ 3.2x75mm, 4.0x100mm, 5.0x100mm, 5.0x150mm	413.70
-30307T	7	⊕ PH0x75mm, PH1x100mm, PH2x100mm ⊖ 3.2x75mm, 4.0x100mm, 5.0x150mm, 6.0x150mm	407.30
-30407T	7	⊕ PH1x100mm, PH1x150mm, PH2x150mm ⊖ 4.0x100mm, 5.0x100mm, 5.0x150mm, 6.0x150mm	421.30

Industrial Precision Screwdriver Sets in Plastic Boxes

- High strength chrome molybdenum alloy blade, hardness up to HRC54-57
- Blades are phosphated and chrome plated
- Plastic handle, exquisite and beautiful



Order Code	No. of pieces	Size	Price RM
TMSC45			
-01004T	4	⊕ PH00 x 40mm, PH1 x 40mm ⊖ 2.0 x 40mm, 3.0 x 40mm	74.40
-02007T	7	⊕ PH00 x 40mm, PH0 x 40mm, PH1 x 40mm ⊖ 1.6 x 40mm, 2.0 x 40mm, 2.4 x 40mm, 3.0 x 40mm	119.40
-03012T	12	⊕ PH00 x 50mm, PH0 x 50mm, PH1 x 50mm ⊖ 2.0 x 50mm, 2.4 x 50mm, 3.0 x 50mm ⊖ T7 x 50mm, T8 x 50mm, T9 x 50mm, T10 x 50mm, T15 x 50mm, T20 x 50mm	189.90

12Pc Industrial Go-through Screwdriver Set

- S2 high-strength alloy steel blades, hexagon bolster for apply extra torque, magnetic tips, strong and durable, wear-resistant
- Ergonomic TPR soft plastic handle, comfortable and effortless in use
- Blow case packaging, ease of storage and access
- In accordance with the German DIN standard

⊖ Slot:	⊕ Cross:
3 x 75mm	PH0 x 75mm
5.5 x 75mm	PH1 x 75mm
6.5 x 38mm	PH2 x 38mm
6.5 x 100mm	PH2 x 100mm
8 x 150mm	PH3 x 150mm
10 x 200mm	PH4 x 200mm



Order Code	No. of pieces	Price RM
TMSC88		
-20112T	12	595.10

7Pc Industrial Screwdriver Set

- Blade is made of S2 high-strength alloy steel, magnetic tips, durable, wear-resistant
- Ergonomic TPR soft plastic handle, comfortable and labor-saving
- Vertical blow case packaging for easy access
- In accordance with German DIN standards
- ⊖ Slot: 3 x 75mm, 6 x 100mm, 8 x 150mm
- ⊕ Cross: PH1 x 100mm, PH2 x 100mm
- ☆ Star: T20 x 100mm, T25 x 100mm



Order Code	No. of pieces	Price RM
TMSC88		
-10107T	7	258.10

7Pc Industrial Torx Screwdriver Set

- Blade is made of S2 high-strength alloy steel, magnetic tips, durable, wear-resistant
- Ergonomic TPR soft plastic handle, comfortable and labor-saving
- Vertical blow case packaging for easy access
- In accordance with German DIN standards
- ☆ Star: T20 x 100mm, T25 x 100mm, T27 x 100mm, T30 x 100mm, T40 x 125mm, T45 x 150mm, T50 x 175mm



Order Code	No. of pieces	Price RM
TMSC88		
-10307T	7	318.10

Professional Impact Screwdriver Kit

- High quality chrome vanadium steel bits
- Plastic sleeve, anti-impact, shockproof, non-slip, comfortable use
- Bits (Slot, Cross): 2-piece 5/16 "Hex x 70mm, 4-piece 5/16 "Hex x 35mm
- Impact resistant plastic case packaging



Order Code	No. of pieces	Size	Price RM
TMSC50			
-10007A	7	5/16" Hex Drive	83.90

Industrial Impact Screwdriver Kit

- High quality chrome vanadium steel
- Chrome-plated, engraved, non-slip, oil resistant
- Bits (Slot, Cross): 2-piece 5/16 "Hex x 70mm, 4-piece 5/16 "Hex x 35mm
- Self-locking metal box



Order Code	No. of pieces	Size	Price RM
TMSC50			
-20007B	7	5/16" Hex Drive	83.90

Spiral Ratchet Screwdrivers

- Widely used in field work situations and small spaces
- Screw can be quickly tightened or loosened
- 3 positions adjustable ratchet, quick-change chuck
- Chrome plated surface, solid wood handle
- 4-piece standard bits



Order Code	No. of pieces	length (mm)	Price RM
TMSC49			
-10440T	5	440	83.90

32Pc Screwdriver Bit Set

- Made of high-strength alloy steel, durable, wear-resistant and anti-rust
- Visible cover for greater transparency in the box.
- Self locking extension rod: 67mm
- 1/4" Hex x 25mm (L) Change the bead quickly
- 1/4" Hex x 25mm (L) bits:
 - ⊖ Slot: 3, 4, 5, 6mm
 - ⊕ Cross: 1 x PH1, 2 x PH2, 1 x PH3
 - ⊗ Pozidriv: 1 x PZ1, 2 x PH2, 1 x PH3
 - ⊙ Hexagon: 3, 4, 5, 6mm
 - ⊛ Star: T10, T15, T20, T25, T27, T30, T40
 - ⊚ Tamperproof Tx: T10, T15, T20, T25, T27, T30, T40



Order Code	No. of pieces	Price RM
TMBT88	32	199.00
-10032T		

40Pc Screwdriver Bit Set

- Made of S2 high-strength alloy steel, durable, wear-resistant
- 3/8" Dr. Hex Bit Adaptor
- 1/2" Dr. Hex Bit Adaptor
- 19-piece 1/4" Hex x 30mm (L) scredriver bits :
 - ⊙ Hexagon: 4, 5, 6, 7, 8, 10, 12mm
 - ⊛ Star: T20, T25, T30, T40, T45, T50, T55
 - ⊗ Spline: 5, 6, 8, 10, 12mm
- 19-piece 1/4" Hex x 75mm (L) long scredriver bits:
 - ⊙ Hexagon: 4, 5, 6, 7, 8, 10, 12mm
 - ⊛ Star: T20, T25, T30, T40, T45, T50, T55
 - ⊗ Spline: 5, 6, 8, 10, 12mm



Order Code	No. of pieces	Price RM
TMBT88	40	315.50
-11040T		

38Pc Socket & Screwdriver Bit Set

- Made of S2 high-strength alloy steel, durable, wear-resistant
- 1/4" Dr. 72 teeth ratchet wrench
- 1/4" Dr. sliding T-handle: 115mm
- 1/4" Dr. quick change extension bar: 100mm, 150mm
- 1/4" Dr. quick change adapter
- 1/4" Dr. sockets: 5, 6, 7, 8, 9, 10, 11, 12, 13mm
- 1/4" Hex x 25mm (L) colored bits:
 - ⊖ Slot: 4.5, 5.5, 6.5mm
 - ⊕ Cross: 1 x PH1, 2 x PH2, 1 x PH3
 - ⊗ Pozidriv: 1 x PZ1, 2 x PZ2, 1 x PZ3
 - ⊙ Hexagon: 2.5, 3, 4, 5, 6mm
 - ⊛ Star: T9, T10, T15, T20, T25, T27, T30, T40



Order Code	No. of pieces	Price RM
TMBT88	38	492.40
-10038C		

100Pc Screwdriver Bit Set

- Made of S2 high-strength alloy steel, durable, wear-resistant
- 1/4" Hex x 65mm (L) quick change adapter
- 1/4" Hex magnetic adaptor
- 98-piece 1/4" Hex x 25mm (L) scredriver bits :
 - ⊖ Slot: 4 x 4mm, 4 x 4.5mm, 4 x 5mm, 4 x 5.5mm, 4 x 6mm, 4 x 8mm
 - ⊕ Cross: 4 x PH1, 5 x PH2, 4 x PH3
 - ⊗ Pozidriv: 4 x PZ1, 4 x PZ2, 5 x PZ3
 - ⊙ Hexagon: 4 x 2.5mm, 4 x 3mm, 4 x 4mm, 4 x 5mm, 4 x 5.5mm, 4 x 6mm
 - ⊛ Tamperproof Tx: 4 x T10, 4 x T15, 4 x T20, 4 x T25, 4 x T27, 4 x T30, 4 x T40

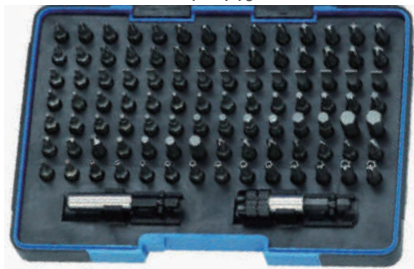

Order Code	No. of pieces	Price RM
TMBT88	100	375.60
-10100T		

8Pc 1/4" Dr. Hex Socket Bit Set

- 8-piece 1/4" Dr. x 37mm (L) socket bit:
 - ⊙ H1.5, H2, H2.5, H3, H4, H5
 - ⊙ H5.5, H6



Order Code	No. of pieces	Price RM
TMSK81	8	103.20
-10108H		

8Pc 1/4" Dr. Long Type Hex Socket Bit Set

- 8-piece 1/4" Dr. x 90mm (L) socket bit:
 - ⊙ H1.5, H2, H2.5, H3, H4, H5
 - ⊙ H5.5, H6



Order Code	No. of pieces	Price RM
TMSK81	8	151.10
-10108L		

9Pc 1/4" Dr. Torx Socket Bit Set

- 9-piece 1/4" Dr. × 37mm (L) socket bit:



T8, T9, T10, T15, T20, T25
T27, T30, T40



Order Code	No. of pieces	Price RM
TMSK81		
-10109T	9	103.20

6Pc 3/8" Dr. Long Type Hex Socket Bit Set

- 6-piece 3/8" Dr. × 100mm (L) socket bit:



T25, T30, T40, T45, T50, T55



Order Code	No. of pieces	Price RM
TMSK81		
-20206L	6	183.10

9Pc 3/8" Dr. Hex Socket Bit Set

- 9-piece 3/8" Dr. × 48mm (L) socket bit:



H2.5, H3, H4, H5, H5.5, H6
H8, H10, H12



Order Code	No. of pieces	Price RM
TMSK81		
-20109H	9	180.40

7Pc 1/2" Dr. Hex Socket Bit Set

- 7-piece 1/2" Dr. × 57mm (L) socket bit:



H4, H5, H6, H8, H10, H12, H14



Order Code	No. of pieces	Price RM
TMSK81		
-30107H	7	228.30

6Pc 3/8" Dr. Long Type Hex Socket Bit Set

- 6-piece 3/8" Dr. × 100mm (L) socket bit:



H4, H5, H6, H8, H10, H12

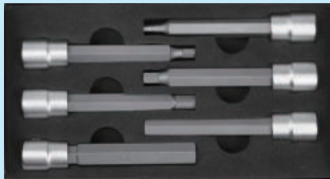

Order Code	No. of pieces	Price RM
TMSK81		
-20106L	6	201.70

5Pc 1/2" Dr. Long Type Hex Socket Bit Set

- 5-piece 1/2" Dr. × 80mm (L) socket bit:



H5, H6, H8, H10, H12



Order Code	No. of pieces	Price RM
TMSK81		
-30105L	5	175.00

9Pc 3/8" Dr. Torx Socket Bit Set

- 9-piece 3/8" Dr. × 48mm (L) socket bit:



T10, T15, T20, T25, T27, T30
T40, T45, T50



Order Code	No. of pieces	Price RM
TMSK81		
-20109T	9	180.40

10Pc 1/2" Dr. Torx Socket Bit Set

- Made of high quality chrome vanadium steel
- Higher torque , durable , wear-resistant



T20, T25, T27, T30, T40
T45, T50, T55, T60, T70



Order Code	No. of pieces	Price RM
TMSK81		
-30210T	10	241.60

9Pc L-Wrench Sets

- Made of high quality chrome vanadium steel
- Matted chrome plated, anti-rust, anti-corrosion, oil resistant



9 piece metric set

Size (mm)	Standard length (mm)	Extra long length (mm)
1.5	44	90
2.0	48	100
2.5	51	112
3.0	57	126
4.0	64	140
5.0	70	160
6.0	83	180
8.0	95	200
10.0	108	224

9 piece imperial set

Size (inch)	Standard length (mm)	Extra long length (mm)
1/16"	44	90
5/64"	48	100
3/32"	51	112
1/8"	57	126
5/32"	64	140
3/16"	70	160
1/4"	83	180
5/16"	95	200
3/8"	108	224

Order Code	No. of pieces	Size range	Price RM
TMWR50			
-81009M	9 piece metric set Standard	1.5 ~ 10.0	46.70
-83009M	9 piece metric set Extra long	1.5 ~ 10.0	60.20
-91009N	9 piece imperial set Standard	1/16" ~ 3/8"	46.70
-93009N	9 piece imperial set Extra long	1/16" ~ 3/8"	60.20

9Pc Ball Driver L-Wrench Sets

- Made of high quality chrome vanadium steel
- Matted chrome plated, anti-rust, anti-corrosion, oil resistant



9 piece metric set

Size (mm)	Standard length (mm)	Extra long length (mm)
1.5	45	90
2.0	50	100
2.5	56	112
3.0	63	126
4.0	70	140
5.0	80	160
6.0	90	180
8.0	100	200
10.0	112	224

9 piece imperial set

Size (inch)	lengthen length (mm)	Extra long length (mm)
1/16"	76	90
5/64"	81	100
3/32"	86	112
1/8"	95	126
5/32"	105	140
3/16"	114	160
1/4"	135	180
5/16"	152	200
3/8"	171	224

Order Code	No. of pieces	Size range	Price RM
TMWR51			
-81109M	9 piece metric set Standard	1.5 ~ 10.0	54.20
-83109M	9 piece metric set Extra long	1.5 ~ 10.0	59.80
-92109N	9 piece imperial set lengthen	1/16" ~ 3/8"	50.90
-93109N	9 piece imperial set Extra long	1/16" ~ 3/8"	69.40

9Pc Torx L-Wrench Sets

- Made of high quality chrome vanadium steel
- Matted chrome plated, anti-rust, anti-corrosion, oil resistant



9Pc Torx L-Wrench Sets

Size	Standard length (mm)	Extra long length (mm)
T10	48	100
T15	54	112
T20	57	126
T25	60	140
T27	63	160
T30	70	170
T40	75	180
T45	81	200
T50	88	224

Order Code	No. of pieces	Size range	Price RM
TMWR52			
-71209T	9 piece Star Standard	T10 ~ T50	61.70
-73209T	9 piece Star Extra long	T10 ~ T50	82.10
-71309T	9 piece Tamperproof Tx Standard	T10 ~ T50	72.40
-73309T	9 piece Tamperproof Tx Extra long	T10 ~ T50	92.80

8Pc Foldable Torx Wrench Set

- Made of high quality chrome vanadium steel
- Matted chrome plated, anti-rust, anti-corrosion, oil resistant
- Two-color plastic anti-slip handle
- Fold-type design, easy to carry, easy to use



Order Code	Size range	Price RM
TMWR55		
-70108T	T9, T10, T15, T20, T25, T27, T30, T40	40.90

Letter Hand Stamp Sets

- High-quality alloy steel, surface blasted, hardness reaching HRC58~60
- Both sides of the font are chamfered
- Letter Set: English letters A~Z and &, 27 pieces



Order Code	Size (mm)	Stamp Size (mm)	Set Description	No. of pieces	Price RM
TMSM10					
-03027L	3	6	Letter	27	128.40
-04027L	4	6	Letter	27	136.10
-05027L	5	8	Letter	27	172.40
-06027L	6	10	Letter	27	224.30
-08027L	8	12	Letter	27	382.00
-10027L	10	12	Letter	27	431.00
-12027L	12	16	Letter	27	679.20

Figure Hand Stamp Sets

- High-quality alloy steel, surface blasted, hardness reaching HRC58~60
- Both sides of the font are chamfered
- Figure set: figure 0-8 (6 and 9 common), 9 pieces



Order Code	Size (mm)	Stamp Size (mm)	Set Description	No. of pieces	Price RM
TMSM11					
-03009F	3	6	Figure	9	45.20
-04009F	4	6	Figure	9	45.20
-05009F	5	8	Figure	9	59.80
-06009F	6	10	Figure	9	77.90
-08009F	8	12	Figure	9	130.50
-10009F	10	12	Figure	9	146.90
-12009F	12	16	Figure	9	229.60

Round Dotted Steel Stamp Sets

- High-quality alloy steel, surface blasted, hardness reaching HRC58~60
- Especially suitable for soft material surfaces, will not damage material after marking
- Both sides of the font are chamfered
- Figure Set: numbers 0 - 8 (6 and 9 common), 9 pieces
- Letter Set: English letters A~Z and &, 27 pieces
- Figure & Letter Set: 9 Figure (0 - 8), 27 Letter (A~Z , &), 36 pieces



Order Code	Size (mm)	Stamp Size (mm)	Set Description	No. of pieces	Price RM
TMSM30					
-03009F	3	10	Figure	9	127.60
-03027L	3	10	Letter	27	374.10
-03036C	3	10	Figure & Letter	36	520.20
-06009F	6	12	Figure	9	244.80
-06027L	6	12	Letter	27	724.80
-06036C	6	12	Figure & Letter	36	987.20
-10009F	10	16	Figure	9	394.80
-10027L	10	16	Letter	27	1175.40

102Pc Fount Sets

- Suitable for aviation, nuclear, oil, and other industries
- High-quality alloy steel, surface blasted, hardness reaching HRC58~60
- Set includes:
 - 1 Steel handle
 - 100 small stamps:
 - 52 Letter stamps (2 each for A~Z)
 - 36 Figure stamps (4 each for 0~8, 6 and 9 are both interchangeable)
 - 1 "&" symbol, 2 "/" symbol, 2 "-" symbol
 - 6 blank, 1 hexagon
- Stamping handle can hold 9 small stamps at a time

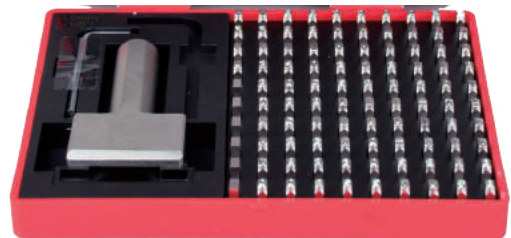

Order Code	Size (mm)	No. of pieces	Price RM
TMSM80			
-03102T	3	102	2374.60

8" Industrial Single Hand Operational Rivet Nut Gun

- Fastening rivets for various types of metal plates, pipes and other manufacturing industries, Currently widely used in automotive, aviation, railway, refrigeration, elevators, switch, instrument, furniture, decoration, and other industries
- Fast riveting speed, easy operation
- Aluminum die-casted body
- Surface treatment: sprayed
- Maximum working stroke: 7mm
- Maximum working effective stroke: 5 - 6mm
- Maximum Arm Ratio: 27
- Weight: 500g
- Standard accessories:
Nut nozzles & rivet nut rod:
M3 - M6



Order Code	Total length	Applicable rivet size	Price / RM
TMP160			
-10200R	8" / 200mm	M3 - M6	337.70

14" Industrial Plastic Body Automatic Rivet Nut Gun

- The latest design, saves up to 40% of labor
- Plastic body, carbon steel handle, ergonomic plastic handle
- Rotary nut loading and unloading structure
- Quick-release screw and knurled adjustable socket
- Maximum working stroke: 7mm
- Maximum Arm Ratio: 38
- Weight: 920g
- Standard accessories:
Nut nozzle & rivet nut rod:
M3 - M12



Order Code	Total length	Applicable rivet size	Price / RM
TMP160			
-30360R	14" / 360mm	M3 - M12	297.10

7-1/2" Industrial Single Hand Operational Rivet Nut Gun

- The latest design, saves more than 40% of labor
- Aluminum die-casted body, carbon steel handle, ergonomic plastic handle
- Free adjustment type fixed socket, more convenient to use
- Maximum working stroke: 7mm
- Maximum Arm Ratio: 26
- Weight: 500g
- Standard accessories:
Nut nozzle & rivet nut rod:
M2.4 - M4.8

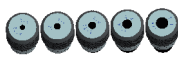

Order Code	Total length	Applicable rivet size	Price / RM
TMP160			
-00190R	7-1/2" / 190mm	Aluminium: M2.4 - M4.8 Sharpen: M2.4 - M4.8 Stainless steel: M2.4 - M4.8	104.00

15" Industrial Heavy Duty Riveter with Stem Collector

- Innovative and labor-saving design, up to 40%, is currently the worlds smallest volume and the lowest effort in the double-barrel riveter of 6.4mm rivets The most easy to use double handles rivet gun
- Aluminum die-casted body, carbon steel handle, ergonomic plastic handle
- Suitable for stainless steel rivets
- Manual adjustable circular knurled socket design makes it easier to remove without using the tools
- 4.3mm thick heat treatment handle; shock-proof design, eliminates the vibration of the rivet gun to the arm during operation
- The knurled nut nozzle is arranged on the bottom cover of the nail collection bottle to save space and facilitate access
- Rivet collection bottle designed to recycle the rivet core and keep the environment clean
- Maximum working stroke: 7mm
- Maximum arm multiple: 30
- Weight: 1200g
- Standard accessories:
Nut nozzle & rivet nut rod: M2.4 - M6.4

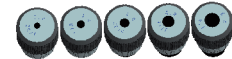

Order Code	Total length	Applicable rivet size	Price / RM
TMP160			
-60380R	15" / 380mm	Aluminium: M2.4 - M6.4 Sharpen: M2.4 - M6.4 Stainless steel: M2.4 - M6.4	173.40

17" Industrial Automatic Nut Riveter

- Aluminum die-casted body, carbon steel handle, ergonomic plastic handle
- The internal use of fixed sliding socket, easy to remove or replace the screw
- Fault hole design, easy to withdraw stuck nuts
- 3mm thick heat treated handle; Shockproof design eliminates the impact of the riveter on the arm during operation
- After riveting the nut, it automatically Exits from the nut without having to unscrew it
- Maximum working stroke: 9mm
- Maximum arm number: 45
- Weight: 1500g
- Standard accessories:
Multi-function wrench,
Nut nozzle &
Rivet nut rod:
M3-M12



Order Code	Total length	Applicable rivet size	Price / RM
TMP160			
-40440R	17" / 440mm	M3 - M12	458.60

8" Industrial T Type Rivet Nut Gun

- The latest design, saves time and effort
- Aluminum die-casted body
- Maximum working stroke: 5mm
- Maximum Arm Ratio: 26
- Weight: 760g
- Standard accessories:
Nut nozzle & Rivet nut rod: M3 - M6



Order Code	Total length	Applicable rivet size	Price / RM
TMPL60			
-50200R	8" / 200mm	M3 - M6	204.90

10" Industrial Folding Riveter

- Innovative and labor-saving design, saves more than 20% of labor
- Aluminum die-casted body, carbon steel connecting piece, ergonomic plastic handle
- Stretch length: 825mm
Contraction length: 250mm
- Maximum working stroke: 9mm
- Maximum Arm Ratio: 56
- Weight: 1471g
- Standard accessories:
Nut nozzle & Rivet nut rod: M2.4-M6.4



Order Code	Total length	Applicable rivet size	Price / RM
TMPL60			
-60250R	10" / 250mm	Aluminium: M2.4 - M6.4 Sharpen: M2.4 - M6.4 Stainless steel: M2.4 - M6.4	154.40

Industrial Pliers

- Made of high quality wear-resistant chrome vanadium steel
- Precision forged, fine processing
- Cutting edges specially quenched to a hardness of up to HRC57- 65
- Ergonomic non-slip double color plastic grip handle, comfortable and labor-saving
- In accordance with American ANSI Standard and German DIN Standard

Combination Pliers

- Jaws close tightly, clamps firmly, strong shearing force, durable
- Jaws are suitable for holding flat and round workpieces
- Cutting edges suitable for cutting soft and hard wire



Order Code	Size	Price RM
TMPL10		
-10150A	6" / 150mm	51.40
-10180A	7" / 180mm	41.90
-10200A	8" / 200mm	62.30

Long Nose Pliers

- Jaws close tightly, clamps firmly, strong shearing force, durable



Order Code	Size	Price RM
TMPL11		
-10150A	6" / 150mm	35.30
-10200A	8" / 200mm	55.10

Heavy Duty Diagonal Cutting Pliers

- Longer cutting edges are precise and smooth, with sharp edges, strong close-fitting shear force, easier heavy-duty operation, tough and durable



Order Code	Size	Price RM
TMPL12		
-20150H	6" / 150mm	39.70
-20180H	7" / 180mm	55.10
-20200H	8" / 200mm	60.70

Flat Nose Pliers

- Jaws close tightly, clamps firmly, strong shearing force, durable



Order Code	Size	Price RM
TMPL14		
-10150A	6" / 150mm	47.50

FUJIYA Pliers & Scissors

- Suitable for various industrial and maintenance fields
- Ergonomic design, comfortable grip and easy operation

Industrial Lineman's Pliers

- Can cut upto: 1.0mm steel bar, 2.5mm stainless steel, 2.5mm steel wire, 4mm iron bars, 6mm cables
- Axis is off centre and easy to operate



Order Code	Total length	Price
FJPL10	RM	RM
-00200A	8" / 200mm	124.00

Industrial Lineman's Pliers

- Can cut upto: 1.5mm steel, 3mm stainless steel, 3mm steel wire, 4mm iron, 6mm cable
- Crimp range: 1.25mm, 2.0mm, 5.5mm, 8mm
- Axis is off centre and easy to operate

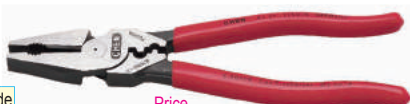

Order Code	Total length	Price
FJPL10	RM	RM
-00230A	9" / 230mm	146.70

Electronics Long Nose Pliers

- Can cut upto: Wire below 2.0mm, copper wire below 3.0mm electrical wire below 3.0mm, steel bar below 1.0mm
- Horizontal teeth



Order Code	Total length	Price
FJPL11	RM	RM
-01180A	7" / 180mm	98.60

Electronics Round Long Nose Pliers

- Can cut upto: 2mm Electrical wire, 2mm copper wires, 1.5mm metal wire
- Horizontal teeth



Order Code	Total length	Price
FJPL11	RM	RM
-02135A	5-5/16" / 135mm	77.40

Electronics Needle Nose Pliers

- Horizontal teeth



Order Code	Total length	Price
FJPL11	RM	RM
-03130A	5-1/8" / 130mm	77.40

Electronics 15° Bent Nose Pliers

- Horizontal teeth



Order Code	Total length	Price
FJPL11	RM	RM
-21160B	6-5/16" / 160mm	93.30

Electronics 45° Bent Nose Pliers

- Horizontal teeth



Order Code	Total length	Price
FJPL11	RM	RM
-22155B	6-1/8" / 155mm	93.30

Electronics 70° Bent Nose Pliers

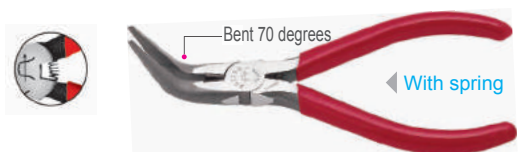

Order Code	Types	Total length	Price
FJPL11	RM	RM	RM
-23150B	Horizontal teeth	6" / 150mm	96.00

Electronics 70° Bent Extra Fine Nose Pliers

- No teeth



Order Code	Total length	Price
FJPL11	RM	RM
-24130B	5-1/8" / 130mm	93.30

Electronics Diagonal Cutters for Plastic

- Can cut upto: 5mm plastic, 2mm steel bars, 1.5mm metal wire

Note: Do not cut steel or acrylic, other hard plastic materials



Order Code	Total length	Price
FJPL12	RM	RM
-00125A	5"/ 125mm	81.30

Electronics Diagonal Cutters for Plastic

- Can cut upto: 6.0mm plastic, 2.5mm steel bars, 2.0mm metal wire

Note: Do not cut steel or acrylic, other hard plastic materials

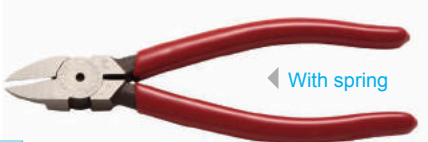

Order Code	Total length	Price
FJPL12	RM	RM
-00165A	6-1/2" / 165mm	85.40

Electrician's Flat Surface Diagonal Cutting Pliers

- Specialized tool for telecommunications equipment
- Can cut electrical wire, metal wire, copper wire, with stripping function
- **Do not cut steel materials**

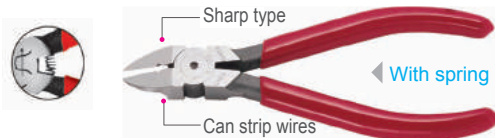

Order Code	Total length	Price
FJPL12	RM	RM
-02160A	6-5/16" / 160mm	89.40

Electronics 45° Diagonal Cutters for Plastic

- Can cut upto: 5mm plastic, 2mm steel bars, 1.5mm metal wire

Note: Do not cut steel or acrylic, other hard plastic materials

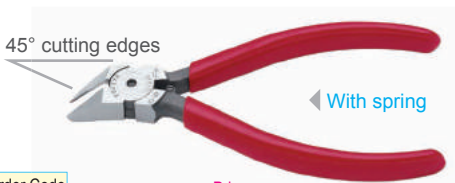

Order Code	Total length	Price
FJPL12	RM	RM
-00150B	6"/ 150mm	110.80

Electronics 90° Diagonal Cutters for Plastic

- Can cut upto: 5mm plastic, 2mm steel bars, 1.5mm metal wire

Note: Do not cut steel or acrylic, other hard plastic materials



Order Code	Total length	Price
FJPL12	RM	RM
-01150B	6"/ 150mm	132.00

Electronics Diagonal Cutters for Plastic - Carbide Blades

- Can be used as electronic diagonal pliers, plastic pliers, electric diagonal pliers, wire cutters
- Tungsten steel blade, flat and sharp
- **Note: Do not cut wires above 0.5mm. Do not twist during use, do not cut any material at the tip**

Do not use the tip to cut any material

Tungsten steel cutting edge

Order Code	Total length	Price
FJPL30	RM	RM
-01150E	6"/ 150mm	234.70

Modern Type Electronics Diagonal Cutters

- Lightweight diagonal pliers designed for electronics, IC boards, precision instruments and other specialties
- Can cut upto: 1.8mm copper wire
- **Note: Do not cut steel materials**

Do not use the tip to cut any material

With spring

Order Code	Total length	Price
FJPL30	RM	RM
-01130E	5"/ 130mm	70.60

ESD Electronics Pliers

- Anti-static diagonal pliers designed for electronics, IC boards, precision instruments, etc. (The rubber sleeve is anti-static)
- Can cut: copper wire below 1.8mm, electrical wire below 1.8mm
- **Note: Do not cut steel materials**

Anti-static

Order Code	Total length	Price
FJPL30	RM	RM
-50125E	5"/ 125mm	72.00

45° ESD Electronics Pliers

- Can cut upto: 1.0mm steel bar, 2.5mm stainless steel, 2.5mm steel wire, 4mm iron bars, 6mm cables
- Axis is off centre and easy to operate

90° cutting edges

 Anti-static

◀ With spring

Order Code	Total length	Price RM
FJPL30		
-51125E	5" / 125mm	77.40

Heavy Duty Diagonal Cutting Nippers

- Specialized tool for machinery, automobiles, electrical equipment, telecommunication maintenance, etc.
- Can cut upto: 2.5mm electrical wire, 3mm copper wire, 1.5mm metal wire, 1mm stainless steel wire
- Do not cut steel materials



With stripping hole,
1.5-2.5mm

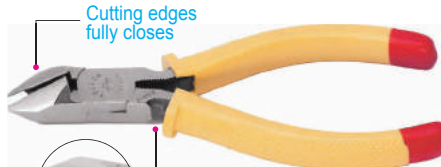

There is a row of
teeth can clip wires

Order Code	Total length	Properties	Price RM
FJPL12			
-03160A	6-5/16" / 160mm	With stripping hole, 1.5-2.5mm	106.70
-03160B	6-5/16" / 160mm	Cutting edges fully closes	110.60

Heavy Duty Full Cr-V Steel Slip Joint Pliers

- Industrial grade, suitable for various industries
- Adjustable opening size



Strong type

Order Code	Total length	Price RM
FJPL15		
-02205A	8-1/16" / 205mm	85.30

Industrial Slip Joint Pliers with Bonded Vinyl-coated Handles

- Industrial grade, suitable for various industries
- Adjustable opening size



Order Code	Total length	Price RM
FJPL15		
-03200A	8" / 200mm	70.60
-03250A	10" / 250mm	96.00

Heavy Duty Automobile Slip Joint Pliers

- Repair tools for automobiles, hydropower and machinery
- Cross teeth
- Adjustable opening size

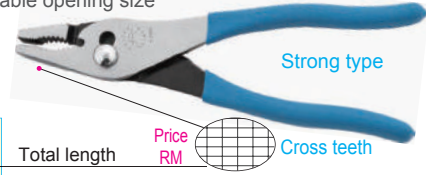

Strong type

Cross teeth

Order Code	Total length	Price RM
FJPL15		
-00215A	8-1/2" / 215mm	174.70

External Circlip Pliers - Straight Nose

- Repair tools for automobiles, hydropower and machinery



◀ With spring

Order Code	Total length	Range of use (mm)	Tip diameter (mm)	Price RM
FJPL20				
-00140A	5-1/2" / 140mm	10~25	1.5~2.0	82.70
-00180A	7" / 180mm	10~40	2.0~2.5	82.70
-00245A	9-3/5" / 245mm	32~80	2.5~3.0	134.70

External Circlip Pliers - Bent Nose



◀ With spring

Order Code	Total length	Range of use (mm)	Tip diameter (mm)	Price RM
FJPL20				
-01140B	5-1/2" / 140mm	10~25	1.5~2.0	82.70
-01175B	6-7/8" / 175mm	10~40	2.0~2.5	82.70
-01230B	9" / 230mm	32~80	2.5~3.0	134.70

Internal Circlip Pliers - Straight Nose

- Repair tools for automobiles, hydropower and machinery



◀ With spring

Order Code	Total length	Range of use (mm)	Tip diameter (mm)	Price RM
FJPL20				
-10140A	5-1/2" / 140mm	10~25	1.5~2.0	82.70
-10180A	7" / 180mm	12~65	2.0~2.5	82.70
-10245A	9-3/5" / 245mm	32~80	2.5~3.0	134.70

Internal Circlip Pliers - Bent Nose



◀ With spring

Order Code	Total length	Range of use (mm)	Tip diameter (mm)	Price RM
FJPL20				
-11140B	5-1/2" / 140mm	10~25	1.5~2.0	82.70
-11175B	6-7/8" / 175mm	12~65	2.0~2.5	82.70
-11230B	9" / 230mm	32~80	2.5~3.0	134.70

240mm Push Button Water Pump Pliers

- Chrome vanadium steel heat treated
- Black surface treatment, anti-corrosion and anti-rust



Order Code	Total length	Maximum opening	Price RM
FJPL45			
-01240A	9-1/2" / 240mm	35mm	206.70

305mm Push Button Water Pump Pliers

- Chrome vanadium steel heat treated
- Black surface treatment, anti-corrosion and anti-rust



Order Code	Total length	Maximum opening	Price RM
FJPL45			
-01305A	12" / 305mm	45mm	258.70

260mm Slip Joint Water Pump Pliers

- Chrome vanadium steel heat treated
- Surface shine treatment, anti-corrosion anti-rust

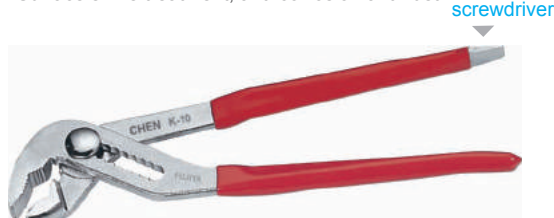

Order Code	Total length	Maximum opening	Price RM
FJPL45			
-02260A	10" / 260mm	40mm	100.10

285mm Groove Joint Water Pump Pliers



Order Code	Total length	Maximum opening	Price RM
FJPL45			
-03285A	11" / 285mm	50mm	134.70

410mm Groove Joint Water Pump Pliers



Order Code	Total length	Maximum opening	Price RM
FJPL45			
-03410A	16" / 410mm	100mm	288.10

Japanese Style Long Jaw Water Pump Pliers



Order Code	Total length	Maximum opening	Price RM
FJPL45			
-04270L	10-1/2" / 270mm	55mm	138.60
-04325L	12-1/2" / 325mm	60mm	181.40

Revolving Leather Punch Tool

- Special punching pliers for leather below 4.0mm
- Hole diameter range: 2.0mm, 2.5mm, 3.0mm, 3.5mm, 4.0mm, 4.5mm

Please often clean crumbs in holes



Order Code	Total length	Price RM
FJPL05		
-01230A	9" / 230mm	125.30

Interchangeable Leather Punch Pliers

- Special punching pliers for leather and cardboard
- Hole diameter range: 1.0mm, 2.0mm, 3.0mm, 4.0mm, 5.0mm, 6.0mm



Order Code	Total length	Price RM
FJPL05		
-00180A	7" / 180mm	149.30

TEMO[®] 4-in-1 Interchangeable Head Snap Ring Pliers Set

- Made of high grade carbon steel.
- 4-in-1 (2 x straight Nose , 1 x 45° , 1 x 90°) Interchangeable , easy to use.

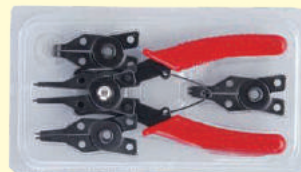

Order Code	total length (mm)	Range of use (mm)	Price RM
TMPL20			
-70004T	155	10 - 25	64.00

Cable Strippers

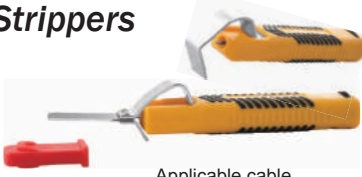

Order Code	Total length	Applicable cable diameter	Price RM
FJHT01			
-00140A	140mm	0.4~28mm	100.30
-00160A	160mm	28~35mm	102.40
-00170A	170mm	35~50mm	106.70
-00190A	190mm	8~28mm(Bladed edge)	111.00

Wire Strippers

- Single wire, manual stripping pliers, with trimming and clamping functions
- Stripping diameter range: 0.2mm、0.3mm、0.4mm、0.5mm、0.6mm、0.8mm



◀ With spring

Order Code	Total length	Price RM
FJPL37		
-00155A	6"/ 155mm	92.00

Heavy Duty Automatic Wire Strippers

- Single wire, automatic wire stripper
- Stripping diameter range: 1.0mm、1.6mm、2.0mm、2.6mm、3.2mm

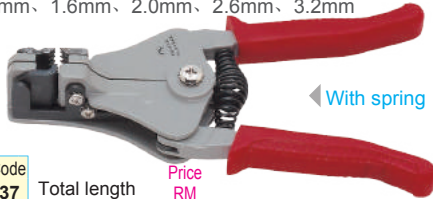

◀ With spring

Order Code	Total length	Price RM
FJPL37		
-20175A	175mm	196.10

Automatic Wire Strippers

- Wire stripping, rapid stripping in the middle, crimping and cutting function
- Stripping diameter range: 0.3~6.0mm • Do not overload



Order Code	Total length	Price RM
FJPL37		
-21210A	210mm	170.70

Heavy Duty Automatic Wire Strippers

- Stripper for flat wire, single wire and multi-core wire, with wire cutting function
- Stripping diameter range: 0.2~4.0mm
- Do not overload



Order Code	Total length	Price RM
FJPL37		
-22170A	170mm	128.10

Crimping Pliers

- Ergonomic design, comfortable grip and easy operation
- Application range: YO type terminal
- Crimping style: point type



Order Code	Total length	Crimping range	Weight	Price RM
FJPL38				
-00200C	200mm	JIS(mm)1.25 - 2.0	230g	298.70

Crimping Pliers

- Ergonomic design, comfortable grip and easy operation
- Application range: YO type terminal
- Crimping style: point type



Order Code	Total length	Crimping range	Weight	Price RM
FJPL38				
-01260C	260mm	JIS(mm)1.25 - 2.0 - 5.5 - 8.0	420g	294.50

Heavy Duty Ratchet Crimping Pliers

- Non-insulated terminals, insulated terminals, YO insulation (non-insulated terminals), European bushing insulated terminals, COAX/BNC and TNC connector series, etc.
- Replacable head



Order Code	Total length	Crimping range	Price RM
FJPL38			
-20200C	200mm	AWG 10/8/6, DIN 6/10/16mm ²	296.60
-21200C	200mm	AWG 22/20/18/16/14/12/10/8/6, DIN 0.5/0.75/1.0/1.5/2.5/4/6/10/16mm ²	296.60
-22200C	200mm	AWG 22-18/16-14/12-10, DIN 0.5-1.0/1.5-2.5/4-6mm ²	296.60

Modular Crimping Tool

- 4P4C, 6P6C, 8P8C three-in-one multi-function
- Attached wire cutting blade and stripping function

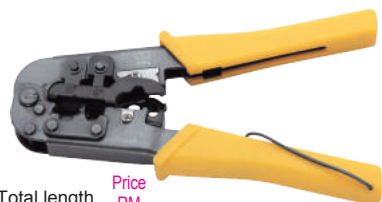

Order Code	Total length	Price RM
FJPL38		
-70468N	191mm	224.00

TEMO[®] Tinsnips - British Style INDUSTRIAL

- Suitable for various industrial and maintenance fields
- Spring assisted, comfortable grip, easy to operate
- Shear application of iron, copper, stainless steel, cold steel, hard steel plate, etc

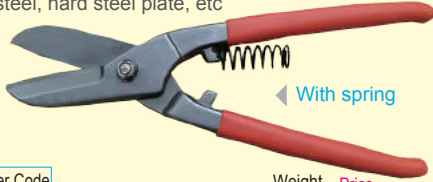

Order Code	Size	Weight (g)	Price RM
TMSS60			
-01200A	8"/200mm British Style Tinsnips	309	61.70
-01250A	10"/250mm British Style Tinsnips	472	75.90
-01300A	12"/300mm British Style Tinsnips	680	90.00
-01360A	14"/360mm British Style Tinsnips	845	103.60

Heavy Duty Aviation Tin-Snips

- Cut soft copper, cold rolled steel, hard steel and stainless steel
- The knife edge adopts special steel, more than 3 times the USA standard, and with normal use can reach above 100,000 times
- Can cut upto: 1.5mm soft copper, 1.2mm cold rolled steel, 0.8mm hard steel, 0.7mm stainless steel



Left-handed



Right-handed

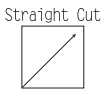

Straight

Order Code	Type	Total length	Price RM
FJSS61			
-01245L	Left-handed	9-1/2" / 245mm	149.30
-01245R	Right-handed	9-1/2" / 245mm	149.30
-01250A	Straight	10" / 250mm	149.30
-01285L	Longer Straight	11-3/16" / 285mm	181.40

45° Carpet Scissors

- Can cut carpet, sheet, wave board, cardboard, etc.
- 45° bevel, prevents harm to hands



Order Code	Total length	Price RM
FJSS50		
-01250B	10" / 250mm	160.00

Multi-Purpose Stainless Steel Scissors

- Ergonomic design, comfortable grip and easy operation
- Cutting applications for gardening, cloth, leather and food



Order Code	Total length	Blade length	Price RM
FJSS10			
-00235A	9-1/4" / 235mm	63mm	168.10

Professional Multi-Purpose Stainless Steel Scissors

- Ergonomic design, comfortable grip and easy operation
- Widely used in various industrial fields, the edge is fine-toothed
- Cutting applications of optical fibers, copper wires, fine iron wires, stainless steel sheets, thin lead sheets, and foods
- Blade material: 420 J2 Japanese stainless steel



Order Code	Total length	Price RM
FJSS10		
-01185A	7-1/4" / 185mm	130.70
-01210A	8-1/4" / 210mm	134.70

Fiber Optic Cutters

- Ergonomic design, comfortable grip and easy operation
- Kevlar and fiber scissors
- The edge is fine-toothed



Order Code	Total length	Cut length	Price RM
FJSS09			
-00145A	5-3/4" / 145mm	32mm	181.40

Fiber Optic Cutters

- Ergonomic design, comfortable grip and easy operation
- Kevlar and fiber scissors
- The edge is fine-toothed



Order Code	Total length	Cut length	Price RM
FJSS09			
-01160A	6-1/4" / 160mm	42mm	192.00

Tailor's Scissors

- Ergonomic design, comfortable grip and easy operation
- Cutting applications for materials such as cloth, leather, and plastic



Order Code	Total length	Price RM
FJSS01		
-00230A	9" / 230mm	160.00

Stainless Steel Poly Handled Multi-Purpose Scissors

- Pleasant grip and firm hold thanks to ergonomically shaped handles and Softgrip grip surface
- Lightweight spring mechanism to gently open the blade and prevent hand fatigue
- Perfect for cutting fabric, felt, ribbon, string, paper and Industrial materials.



Order Code	Model	Total Length	Price RM
FJSS11			
-01165A	Straight	6-1/2" / 165mm	95.00
-01150B	Curved	6" / 150mm	95.00

Stainless Steel Straight Blade Fruit Scissors

- Pleasant grip and firm hold thanks to ergonomically shaped handles and Softgrip grip surface
- Lightweight spring mechanism to gently open the blade and prevent hand fatigue
- Perfect for cutting tree branches and Industrial materials.
- Spring loaded mechanism that easy cut branches in less efforts.



Order Code	Total Length	Price RM
FJSS30		
-02200A	8" / 200mm	130.00

Multi-Purpose Stainless Steel Bent Blade Hedge Scissors

- Pleasant grip and firm hold thanks to ergonomically shaped handles and Softgrip grip surface
- Lightweight spring mechanism to gently open the blade and prevent hand fatigue
- Perfect for cutting tree branches and Industrial materials.
- Spring loaded mechanism that easy cut branches up to 20mm in less efforts.

◀ The blade is made of SK-5 steel



Order Code	Total Length	Price RM
FJSS30		
-01205B	8" / 205mm	169.00

Stainless Steel Bent Blade Hedge Scissors

- Pleasant grip and firm hold thanks to ergonomically shaped handles and Softgrip grip surface
- Lightweight spring mechanism to gently open the blade and prevent hand fatigue
- Perfect for cutting tree branches and Industrial materials.
- Spring loaded mechanism that easy cut branches up to 15mm in less efforts.



Order Code	Total Length	Price RM
FJSS30		
-02205B	8" / 205mm	130.00

Stainless Steel Labor-saving Hedge Scissors

- Pleasant grip and firm hold thanks to ergonomically shaped handles and Softgrip grip surface
- Lightweight spring mechanism to gently open the blade and prevent hand fatigue
- Perfect for cutting tree branches and Industrial materials.
- Spring loaded mechanism that easy cut branches up to 20mm in less efforts.



Order Code	Total Length	Price RM
FJSS30		
-03205B	8" / 205mm	138.00

Stainless Steel Precision Long Nose Electronic Scissors

- These high quality, forged, cuticle scissors feature smooth, rounded handles with comfortably sized openings for finger and thumb.
- Perfect for electronic and precision Industries used.
- Extra-fine tips for maximum precision and control
- The curved blades model eliminate ragged cuticles and hangnails so the area around your nails looks tidy and well groomed.
- Sharp, pointed tips provide precision and accuracy, even in small areas and tight corners

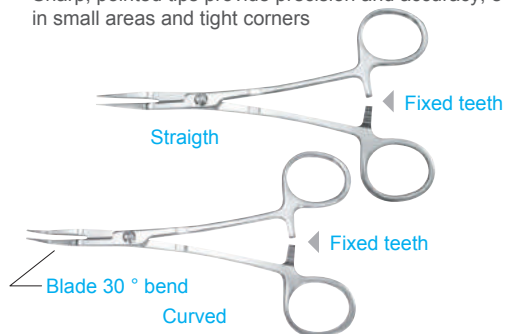

Order Code	Model	Total Length	Price RM
FJPL35			
-01160A	Straight	6-1/4" / 160mm	125.00
-01160B	Curved	6-1/4" / 160mm	125.00

Grip Wrenches

- Chrome molybdenum steel
- Obtain the required clamping force by adjusting the tail bolt and lock it
- Has the function of ordinary clamp products
- Accurate bite, strong grip

Straight Jaw Grip Wrenches



Order Code	Size	Price RM
TMPL50		
-01180A	7" / 180mm	75.20
-01250A	10" / 250mm	85.20

Curved Jaw Grip Wrenches



Order Code	Size	Price RM
TMPL50		
-02180B	7" / 180mm	76.00
-02250B	10" / 250mm	84.40

Locking C-Clamp



Order Code	Size	Price RM
TMPL50		
-10280C	11" / 280mm	145.30

Chain Grip Wrench



Order Code	Size	Chain length	Holding diameter	Price RM
TMPL50				
-15230D	9" / 230mm	19" / 480mm	12mm	88.50

Cable Tie Guns

for Nylon Cable Ties for S/Steel Ties

- For Nylon cable ties use.
- Applicable cable tie range 2.4 - 4.8mm
- The cable length is not limited . It can be automatically cut off.
- Adjustable , easy to operate.
- For stainless steel cable ties use.
- Gun body made of high quality carbon steel , alloy steel cutting blades.
- Precision design allows the user to apply the greatest force with the minimum amount of effort for maximum tightening.
- Anti-corrosive , ideal for outdoor or high temperatures production environments.



Order Code	Purpose	Applicable strap width(mm)	Applicable tie thickness(mm)	Price RM
TMHT02				
-01005A	for Nylon Cable Ties	2.4 - 4.8	≤ 1.6	130.00
-02012A	for S/Steel Ties	4.6 - 12.0	≤ 3.0	289.00

Nylon Cable Ties

- Made of UL certified Nylon 66, fire-proof level 94V-2, aging resistant, strong endurance
 - Use temperature: -40°C ~ 85°C
 - Weight: 22kgs (50lbs)
 - Minimum packing: 100 pieces/bag
 - **Banding gun order number : TMHT02-01005A**
- See the bottom left of this page for details



length (mm)	width (mm)	Maximum beam diameter (mm)	Price RM	white	black	
				Order Code TMOT40	Price RM	Order Code TMOT40
120.00	4.80	27.00	6.40	-01120A	6.40	-01120B
160.00	4.80	39.00	9.70	-01160A	9.70	-01160B
203.00	4.80	52.00	11.70	-01200A	11.70	-01200B
250.00	4.80	68.00	13.90	-01250A	13.90	-01250B
350.00	4.80	98.00	21.80	-01350A	21.80	-01350B
400.00	4.80	116.00	24.10	-01400A	24.10	-01400B
450.00	4.80	131.00	28.40	-01450A	28.40	-01450B
550.00	4.80	162.00	34.70	-01550A	34.70	-01550B
610.00	4.80	181.00	38.70	-01610A	38.70	-01610B

Stainless Steel Cable Ties

- Made of stainless steel 316SS, very strong endurance
 - Applicable to various industries such as engineering, aviation, and shipbuilding, as well as indoor and outdoor places, humid, hot, cold environments, etc.
 - Wear resistant, acid and alkali resistant, weather resistant and fire resistant.
 - Fast locking function
 - **Banding gun order number: TMHT02-02012A**
- See the bottom left of this page for details



Stainless steel						
Order Code	length (mm)	width (mm)	Maximum beam diameter (mm)	Load capacity (lbs)	Packing (per package)	Price RM
TMOT40						
-20127A	127.00	4.60	25.00	100	100	74.30
-20152A	152.00	4.60	33.00	100	100	78.10
-20201A	201.00	4.60	51.00	100	100	86.00
-20266A	266.00	4.60	69.00	100	100	93.80
-20300A	300.00	4.60	80.00	100	100	101.60
-20362A	362.00	4.60	102.00	100	100	109.40
-20521A	521.00	4.60	152.00	100	100	136.80
-20679A	679.00	4.60	203.00	100	100	175.90

Deburring Tool Sets

- Ergonomic handle design, comfortable grip, easy to use

Type B

- Universal model for deburring holes, slots and edges
- Can install all B-type cutter heads. The cutter head can be loaded axially or radially into the holder

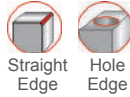

Type C

- For high-quality finishing and scraping, triangular scraper, three-sided cutting edge, retractable shank, with loading and unloading blade tools

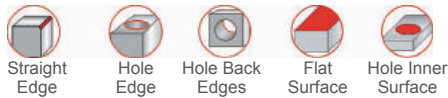

Type D

- For 3-8mm (0.12-0.31") thickness metal plate processing, can process both sides of the sheet at a time

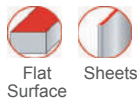

Type E

- For heavy load remove burrs of holes, slots and edges
- Can install all E-type blades

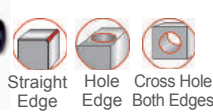

Type F

- For chamfering within 20mm (0.79")



Type FR

- For chamfering within 20mm (0.79")
- Ratchet Arbor is more suitable for narrow space



Order Code	Type	Blade Holder	Suitable For Type	Price RM
TMHT10				
-00101B	B	B	B10, B20	176.30
-00102C	C	C	C42	275.50
-00103D	D	D	D80C	213.80
-00104E	E	E	E100, E200, E300	176.30
-00105F	F	F	F20	304.20
-00106F	FR	FR	F20	562.00

Deburring & Scraping Sets

- Ergonomic handle design, comfortable grip, easy to use

Standard Duty Set

- Handle, B-type holder, C-type holder, B10, B20, B30, B60, B11, B70 carbide tipped, C40 and C scraper



Standard Duty Set

Heavy Duty Set

- Handle, E-type holder, C-type holder, C42, E100P, E111, E200, E300, E700 blade and C scraper



Heavy Duty Set

Thin Sheet Set I

- Handle, E-type holder, C-type holder, C42, E100P, E111, E200, E300, E700 blade and C scraper



Thin Sheet Set I

Thin Sheet Set II

- Handle, 5 different diamond coated files + E100S, E400 Blades



Thin Sheet Set II

Order Code	Set type	Price RM
TMHT10		
-00801T	Standard	551.00
-00802T	Heavy	573.10
-00803T	Thin plate type I	617.10
-00804T	Thin plate type II	837.60

















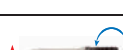



Telescopic Blade Holders for Deburring Tools



Order Code	Type	Suitable For Type	Price RM
TMHT10			
-29004E	E	All E-type blade	94.80
-29000B	B	All Type B blade	94.80
-29001C	C	C40 and C42 Scraper	94.80
-29002D	D	D80C and D82C blade	110.20
-29005F	F	All F-type Countersinks	94.80
-29006R	FR	Ratchet type, suitable for all F-type Countersinks	254.60

Blades

★ Commonly used blades

Blade Type	Order Code TMHT10	Description	Blade Working Direction	Application											Material								Price RM	
				Straight Edge	Hole Edge	Outer Edge	Cross Both Edges	Reverse Edge	Hole Inner Surface	Flat Surface	Sheets	Slot Keyway	Inner Straight Corners	Steel	Aluminum	Copper	Brass	Cast Iron	Stainless Steel	Hardened Steel	Plastics	Carbide Glass		
B10	-09010B	High-speed steel, suitable for processing long-cut materials	★ 	•	•												•	•	•				•	99.20
B11	-09011B	Ultra-thin blade, high speed steel, minimum machining hole of only 2mm (0.08")		•	•												•	•	•				•	143.30
B20	-09020B	High-speed steel, can process both left-handed and right-handed	★ 	•	•													•	•				•	143.30
B30	-09030B	Continuously remove both internal and external burrs, maximum processing thickness up to 4mm (0.16")	★ 				•										•	•	•				•	176.30
B60	-09060B	High-speed steel, specially for reverse edge deburring up to 20mm (0.8") in diameter								•							•	•	•				•	242.50
B70	-09070B	Soldered carbide head, specially for sheets deburring up to 3.5mm (0.14") in thickness											•				•	•	•	•	•	•	•	1344.50
C40	-09040C	Small high-speed steel triangular blade, 4mm (0.16")	★ 														•	•	•	•	•	•	•	661.20
C42	-09042C	Standard size high speed steel triangular blade, 8mm (0.31")	★ 														•	•	•	•	•	•	•	1454.70
D80C	-09080D	Carbide six-edge blade, specially for deburring sheet metal up to 3.5mm (0.14") in thickness															•	•	•	•	•	•	•	903.70
D82C	-09082D	Heavy-duty cutting double-edged blades, specially for deburring sheet metal up to 9 mm(0.35") in thickness															•	•	•	•	•	•	•	1344.50
E100	-09100E	HSS heavy duty blade for use on material with spiral chips	★ 	•	•												•	•	•				•	105.80
E100P	-09101E	With high wear resistance TiN coating, same shape as E100		•	•												•	•				•	•	277.70
E100S	-09102E	High cobalt content for hardened materials, long lifespan, same shape as E100		•	•												•	•	•			•	•	149.90
E111	-09111E	HSS thin nose blade, machining min hole diameter of 1.5mm (0.06")		•	•												•	•	•				•	149.90
E120	-09120E	E-type, B20 blade design allow clockwise & anti-clockwise processing, suitable for processing powdery chips workpieces.		•	•														•	•			•	149.90
E200	-09200E	HSS blade design allow clockwise & anti-clockwise processing, suitable for powdery chips workpiece.	★ 	•	•													•	•				•	149.90
E300	-09300E	HSS blade for processing material with spiral chips. Continuously & simultaneously remove the burrs in the inner and outer of the hole. The max processing thickness is 6mm (0.24")	★ 				•										•	•	•					198.40
E400	-09400E	Mini triangular scraper		•						•	•	•					•	•	•	•	•	•	•	573.10
E700	-09700E	HSS blade for processing on material with spiral chips. Particularly suitable for holes in thin plate and through hole.															•	•	•				•	242.50
F20	-09020F	For hole chamfering up to diameter of 20mm (0.78") hole	★ 		•												•	•	•	•	•	•	•	220.40

American Pattern Pipe Wrenches

- Overall heat treatment, jaw induction quenching head treated, durable
- Aluminium handle pipe wrenches are approximately 40% lighter than cast irons of the same size, lightweight and durable
- Special upper and lower jaws occlusion design, powerful clamping force
- The preferred tool for oil field work and other heavy-duty operations

Heavy-duty pipe wrench



Aluminum handle pipe wrench

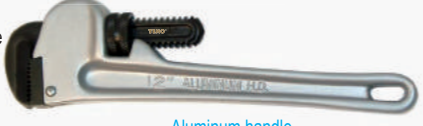

Heavy-duty pipe wrench

Order Code	Size	Price RM
TMPW10		
-00150H	6" / 200mm	37.10
-00200H	8" / 200mm	43.10
-00250H	10" / 250mm	52.80
-00300H	12" / 300mm	74.00
-00350H	14" / 350mm	94.00
-00450H	18" / 450mm	131.40
-00600H	24" / 600mm	208.50
-00900H	36" / 900mm	455.60
-01200H	48" / 1200mm	718.60
-01500H	60" / 1500mm	1653.40

Aluminum handle pipe wrench

Order Code	Size	Price RM
TMPW20		
-00250A	10" / 250mm	78.60
-00300A	12" / 300mm	103.80
-00350A	14" / 350mm	117.60
-00450A	18" / 450mm	184.50
-00600A	24" / 600mm	278.40
-00900A	36" / 900mm	552.30
-01200A	48" / 1200mm	1089.80

Bolt Cutters

- Chromium molybdenum alloy steel jaws, hardness: HRC55 - 60
- Wire shear hardness: HRC40



Order Code	Size	Price RM
TMCU10		
-00300B	12" / 300mm	192.60
-00350B	14" / 350mm	196.30
-00450B	18" / 450mm	261.50
-00600B	24" / 600mm	376.40

Order Code	Size	Price RM
TMCU10		
-00750B	30" / 750mm	518.60
-00900B	36" / 900mm	666.20
-01050B	42" / 1050mm	905.70

Aluminum Handled Bolt Cutters

- Lightweight and durable aluminum handle
- Chromium molybdenum alloy steel jaws, hardness: HRC55 - 60
- Wire shear hardness: HRC40



Order Code	Size	Price RM
TMCU20		
-00300A	12" / 300mm	173.70
-00350A	14" / 350mm	181.10

Heavy Duty Chain Pipe Wrenches

- Industrial grade chain pipe wrench, extended handle length makes it ideal for heavy-duty job.
- High tensile chain ensures firm grip for east operation
- The preferred tool for oil field work and other heavy-duty



Order Code	Handle Length (mm)	Chain Length (mm)	Capacity (mm)	Weight (kg)	Price RM
TMPW40					
-01004A	940	747	4" / 100mm	8.6	567.30
-01006A	1120	897	6" / 150mm	12.4	866.30
-01008A	1280	1048	8" / 200mm	16.2	1497.00
-01012A	1630	1439	12" / 300mm	28.9	2348.00

Strap Wrenches

- Made of drop forged steel heat treated.



Order Code	Handle Length (mm)	Capacity (mm)	Weight (g)	Price RM
TMPW01				
-01009A	230	60 - 140	334	64.00
-01011A	279	60 - 203	560	99.00

American Pattern Chain Wrenches

- Made of high quality carbon steel , Satin finish.
- Heat treatment , ergonomic design, comfortable grip and easy operation.



Order Code	Handle Length (mm)	Capacity (mm)	Weight (g)	Price RM
TMPW02				
-01012A	300	110	818	136.00
-01015A	380	130	1200	175.80
-01024A	600	170	1750	242.40

PVC Cutters

Quick Style

- Made of durable ABS material , highly polished , easy to use even with tough working conditions.
- Equipped with #65 x 2.00mm thickness sharp cutting blades.
- Suitable for cutting of PPR, PVC, PB, PE and Solar pipe , etc.



H/D Ratchet

- Suitable for cutting of PVC, CPVC, PP, PEX, PE pipe and aluminium pipe , etc.
- Ratchet enables easy operation even with one hand.



Order Code	Model	Opening (mm)	Length (g)	Weight (g)	Price RM
TMCU25					
-82001A	Quick Type	16 - 32	248	136	46.50
-82105A	Ratchet Type	42	235	474	72.50

Bearing Steel Structured Pipe Cutter

- Special tools for refrigeration, suitable for cutting various types of pipe fittings , such as copper pipe, Aluminium pipe , iron pipe and stainless steel pipe.
- The flare groove design of the roller with bearing can effectively reduce the loss of the metal pipe when the damaged flaring is cut.
- Knife body made of aluminium alloy materials.
- The blade is made of bearing steel and can cut pipe fittings accurately and sharply.
- Ergonomic design , comfortable grip and easy operation.



Order Code	Cutting Dia Range(mm)	Price RM
TMCU25		
-02035A	3 - 35	72.00

Replacement Blade

Order Code	Number of packages	Price RM
TMCU25		
-00103P	10	46.30

Aluminum Alloy Structured Pipe Cutters

- Suitable for cutting various types of pipe fittings , such as copper pipe, Aluminium pipe , iron pipe and stainless steel pipe.
- Knife body made of aluminium alloy materials.
- Made of Special heat treated blades, after high frequency quenching, it has long service life
- Dual roller cutters design , durable to use.
- Compact appearance, convenient to carry



Figure 1 - Mini



Figure 2 - I



Figure 3 - II

Order Code	Types	Cutting Dia Range (mm)	Figure	Price RM	Order Code	Number of packages	Price RM
TMCU25					TMCU25		
-02019A	Mini	3 - 19	1	53.60	-00101P	10	46.30
-02032A	I	4 - 32	2	106.90	-00102P	10	143.20
-02050A	I	5 - 50	2	155.40	-00104P	10	143.20
-02065A	II	6 - 65	3	119.00	-00105P	10	46.30

Replacement Blade

3-in-1 Mini Bender

- For 6mm, 8mm, 10mm tubing.
- Easy-to-read bend degree scale aluminium alloy construction.

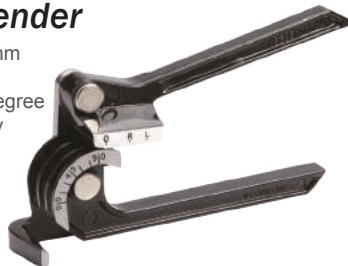

Order Code	Capacity (mm)	Price RM
TMCU24		
-01010A	6, 8 & 10	121.60

Double Flaring Tool & Pipe Cutting Kit

- Made of grade C45 steel
- Double flare tool kit swivel constructed from chrome-plated alloy steel to reduce friction
- For use when flaring double or single flare in copper, aluminum, brass, magnesium, and soft steel brake line tubing

Contains :

- 1 x Flaring tools
- 1 x Spreader : 3/16", 1/4" , 5/16" , 3/8" , 7/16" , 1/2" & 5/8"
- 7 x Flaring press : 3/16", 1/4" , 5/16" , 3/8" , 7/16" , 1/2" & 5/8"
- 1 x cutter : 1/8" - 1-1/8"



Order Code	Contains	Capacity (mm)	Weight (kg)	Price RM
TMCU26				
-80010A	10	3/16" ~ 5/8"	2.2	185.00

45° Copper Tube Flaring & Swaging Tool Kit

- Made of grade C45 steel
- Double flare tool kit swivel constructed from chrome-plated alloy steel to reduce friction
- Widely used for cutting , flaring and swaging of cooper, aluminum, brass, magnesium, and soft steel brake line tubing

Contains :

- 1 x Flaring tools
- 2 x Spreader : 3/16" , 1/4" , 5/16" , 3/8" , 7/16" , 1/2" , 5/8" & 3/4"
- 5 x Flaring press : 3/16", 1/4" , 5/16" , 3/8" , 7/16" , 1/2" , 5/8" & 3/4"
- 1 x cutter : 1/8" - 1-1/8"
- 1 x square double ratchet wrench , 1/4" , 3/8" , 3/16" & 5/16"



Order Code	Contains	Capacity (mm)	Swaging Capacity (mm)	Weight (kg)	Price RM
TMCU26					
-80110A	10	1/8" ~ 3/4"	3/16" ~ 3/4"	2.8	245.00

Ball Pein Hammers - Beech Wood Shafts

- Made of high-quality carbon steel, forging and heat treatment
- Cyclobalanopsis wooden handle, head & handle assemble with glues, durable



Order Code	Size	Length (mm)	Weight (kg)	Price RM
-10010A	1lb / 16oz / 0.45kg	338	0.53	21.80
-10015A	1.5lbs / 24oz / 0.68kg	364	0.81	24.00
-10020A	2.0lbs / 32oz / 0.91kg	382	1.07	27.80

Claw Hammers - Beech Wood Shafts

- Made of high-quality carbon steel, forging and heat treatment
- Cyclobalanopsis wooden handle, head & handle assemble with glues, durable



Order Code	Size	Length (mm)	Weight (kg)	Price RM
-10010A	1lb / 16oz / 0.45kg	332	0.63	24.20
-10015A	1.5lbs / 24oz / 0.68kg	332	0.88	28.30

Club Hammers - Beech Wood Shafts

- Made of high-quality carbon steel, forging and heat treatment
- Cyclobalanopsis wooden handle, head & handle assemble with glues, durable



Order Code	Size	Length (mm)	Weight (kg)	Price RM
-10020A	2.2lbs / 35oz / 1kg	260	1.16	85.10
-10030A	3.3lbs / 53oz / 1.5kg	290	1.67	113.50
-10040A	4.4lbs / 70oz / 2kg	305	2.14	138.60

TEMO® PVC Assembly Hammers - EASYUSE Tubular Steel Shafts

- All purpose PVC hammers used widely for Industrial , automotive and light and heavy duty applications.
- Gentle but firm, blow with little rebound that reduce surface damage when striking.
- Fitted with screw-in durable PVC faces, replacement faces available.
- High strength all steel construction , incredibly strong.
- With textured slip resistant rubber grip. Dampens the impact transmitted through to the user's hand and wrist.



Order Code	Fcae (mm)	Height (mm)	Length (mm)	Weight (g)	Price RM
-01025A	25	64	260	180	23.30
-01030A	30	80	265	260	26.00
-01035A	35	89	270	370	28.70
-01040A	40	91	290	540	33.70
-01045A	45	93	300	650	37.70

White Rubber Mallets - French Style

- All purpose Rubber Mallets used widely for Industrial , automotive and light and heavy duty applications.
- Made of high temperature vulcanised natural rubber , hardness up to 750 .
- Made of genuine hickory with waxed finish , incredibly strong.
- Give a gentle but firm blow with little rebound.



Order Code	Fcae (mm)	Height (mm)	Length (mm)	Weight (g)	Price RM
-02007A	0.75lb / 12oz	92	280	400	27.00
-02010A	1lb / 16oz	100	300	500	29.60
-02015A	1.5lb / 24oz	117	320	750	37.70
-02020A	2lb / 32oz	121	360	1000	43.00

Professional 12" Hacksaw Frame

- Innovative patented design, firm body and beautiful
- The blade can be rotated 360° and set to any angle. Both hands can be easily operated
- Applicable to difficult-to-reach spaces or angles
- By adjusting the spring button, it is easy to tighten the saw blade firmly and keep it in the best working condition.
- The blade can be easily loaded and unloaded by adjusting the spring button



Order Code	Size	Weight (g)	Price RM
-10300A	300mm / 12"	710	149.40

12" D Shape Hacksaw Frame

- Aluminum alloy material, thicker square tube, sturdy and durable
- Ergonomic design, comfortable grip
- Butterfly buckle screw, free adjustment
- 45°/90° double angle loading blade for double angle sawing



Order Code	Size	Weight (g)	Price RM
-20300A	300mm / 12"	472	46.20

Industrial Bi-Metal Hacksaw Blades

- Made of high-quality bimetal
- Sharp, strong toughness, good elasticity, long lifespan
- Packing: 100 pieces (10 sets) plastic box
- MOQ: 10 pieces/set



Order Code	Length	Width	TPI	Price RM
-02212B	12" (300mm)	1/2" (12.5mm)	18	5.20
-02312B	12" (300mm)	1/2" (12.5mm)	24	5.20

Industrial Stainless Steel Tweezers

- Industrial tweezers are tools useful in a range of laboratory and other working environments for gripping and manipulating small or delicate objects.
- Made from finest stainless steel with polish finish and rustless.
- A strong, solid performer for the engineer.

A1 - Sharp nose fine point forceps A2- Long needle nose



A3- Sharp nose tips forceps A4- Sharp nose cross pattern



A5- Needle nose sharp point A6- Bent nose



Order Code	Type	Length (mm)	Price RM
TMOT10			
-50101A	A1	108	15.80
-50102A	A2	133	15.80
-50103A	A3	123	15.80
-50104A	A4	109	15.80
-50105A	A5	114	15.80
-50106A	A6	115	15.80



6Pc Set

Order Code	Type	Price RM
TMOT10		
-58106T	A1, A2, A3, A4, A5, A6	94.60

6Pc Assorted Needle File Sets

- Manufacture of high quality alloy steel
- High hardness, sharp teeth, free chip flow
- Ergonomic two-color handle, moderate hardness, non-slip, anti-fatigue
- Applicable at narrow working areas for finishing or boring small & fine metal parts
- Contains x 1 file each:

- Hand
- Half Round
- Three Square
- Square
- Round
- Taper Flat



Order Code	Size	Price RM
TMFL88		
-11406T	140mm	36.00
-11606T	160mm	38.40
-11806T	180mm	46.00

6Pc Diamond Needle File Sets

- High quality diamond plating, high sharpness, long lifespan
- Ergonomic two-color handle, moderate hardness, non-slip, anti-fatigue
- Applicable at narrow working areas for finishing or boring small & fine hardened metal parts
- Contains x 1 file each:

- Hand
- Half Round
- Three Square
- Square
- Round
- Taper Flat



Order Code	Size	Price RM
TMFL89		
-11406D	140mm	44.00
-11606D	160mm	49.80
-11806D	180mm	62.00

10Pc Diamond Needle File Sets

- High quality diamond plating, high sharpness, long lifespan
- Ergonomic two-color handle, moderate hardness, non-slip, anti-fatigue
- Applicable at narrow working areas for finishing or boring small & fine hardened metal parts
- Contains x 1 file each:

- Hand
- Half Round
- Three Square
- Knife
- Barrette
- Square
- Round
- Taper Flat
- Small Oval
- Oval



Order Code	Size	Price RM
TMFL89		
-21410D	140mm	52.30
-21610D	160mm	66.10
-21810D	180mm	68.10

6Pc Industrial Small Engineer's File Sets

- Small and exquisite, easy to carry, ready to use
- Use special tooth processing and heat treatment process to enable durable teeth
- Wooden handle
- Contains x 1 file each:

- Hand
- Half Round
- Barrette
- Round
- Square



Order Code	Type of Cut	Size	Price RM
TMFL71			
-11506T	Bastard Cut	160mm	54.00
-31506T	Smooth Cut	160mm	76.10

Engineer's Files

Flat Engineer's Files



Size LxWxT(mm)	Bastard Cut		Second Cut		Smooth Cut	
	Order Code	Price RM	Order Code	Price RM	Order Code	Price RM
200 x 20 x 4.5	-01200B	16.10	-01200M	16.40	-01200S	18.20
250 x 24 x 5.5	-01250B	24.00	-01250M	24.60	-01250S	27.60
300 x 28 x 6.5	-01300B	32.30	-01300M	33.00	-01300S	37.70

3 Square Engineer's Files



Size LxWxT(mm)	Bastard Cut		Second Cut		Smooth Cut	
	Order Code	Price RM	Order Code	Price RM	Order Code	Price RM
200 x 13.0 x 13.0	-03200B	15.50	-03200M	18.00	-03200S	20.10
250 x 16.0 x 16.0	-03250B	21.80	-03250M	22.20	-03250S	25.10
300 x 19.0 x 19.0	-03300B	30.60	-03300M	31.50	-03300S	35.60

Square Files



Size LxWxT(mm)	Bastard Cut		Second Cut		Smooth Cut	
	Order Code	Price RM	Order Code	Price RM	Order Code	Price RM
200 x 7.0 x 7.0	-04200B	21.30	-04200M	21.80	-04200S	23.40
250 x 8.5 x 8.5	-04250B	27.60	-04250M	28.40	-04250S	31.10
300 x 10.8 x 10.8	-04300B	34.40	-04300M	35.60	-04300S	39.50

Half Round Engineer's Files



Size LxWxT(mm)	Bastard Cut		Second Cut		Smooth Cut	
	Order Code	Price RM	Order Code	Price RM	Order Code	Price RM
200 x 20 x 5.5	-05200B	13.80	-05200M	16.50	-05200S	18.30
250 x 24 x 7.0	-05250B	21.30	-05250M	21.90	-05250S	24.00
300 x 28 x 8.0	-05300B	26.10	-05300M	26.70	-05300S	30.20

Round Engineer's Files



Size LxWxT(mm)	Bastard Cut		Second Cut		Smooth Cut	
	Order Code	Price RM	Order Code	Price RM	Order Code	Price RM
200 x 7.0 x 7.0	-06200B	15.20	-06200M	15.60	-06200S	17.30
250 x 9.0 x 9.0	-06250B	17.70	-06250M	18.60	-06250S	20.90
300 x 11.0 x 11.0	-06300B	23.40	-06300M	24.60	-06300S	27.60

8Pc Engineer's File Sets

- Good quality oxford-style sleeve bag, beautiful and durable



Order Code	Size	Size (mm)	Price RM
TMFL70			
-00108T	Flat file: Second Cut & Bastard Cut		
	Triangular file: Second Cut & Bastard Cut	250	272.60
	Half Round file: Second Cut & Bastard Cut		
-00208T	Round file: Second Cut & Bastard Cut		
	Flat file: Second Cut & Smooth Cut		
	Triangular file: Second Cut & Smooth Cut	250	285.60
	Half Round file: Second Cut & Smooth Cut		
-00308T	Round file: Second Cut & Smooth Cut		
	Flat file(Second Cut)		
	Triangular file(Second Cut)	250 & 200	262.20
-00408T	Half Round file(Second Cut)		
	Round file(Second Cut)		
	Flat file: Second Cut & Bastard Cut		
	Triangular file: Second Cut & Bastard Cut	250	272.60
-00508T	Half Round file: Second Cut & Bastard Cut		
	Round file: Second Cut & Bastard Cut		
	Flat file: Second Cut & Smooth Cut		
	Triangular file: Second Cut & Smooth Cut	250	285.60
-00608T	Half Round file: Second Cut & Smooth Cut		
	Round file: Second Cut & Smooth Cut		
	Flat file(Second Cut)		
	Triangular file(Second Cut)	250 & 200	262.20

Rotary Pump

- Material: Cast Iron
- Suitable for pumping oil, kerosene, diesel, cooking oil and other oils
- Does not apply to corrosive oils such as gasoline
- Segmented suction tube, easy to handle and carry
- U-shaped oil outlet, more easy for oil flow



Order Code	Discharge per Stroke	Suction Range (m)	Lifting Range (m)	Weight (kg)	Price RM
TMLB02					
-03100A	22L/Minute	1.5	5	5.7	196.20

400cc Industrial Grease Guns

- High quality electroplated steel pipe made by high frequency seam welding
- Industrial quality, excellent cavity seal, durable
- 3 kinds of grease filling methods: bulk filling, cartridge filling, sealed tank filling
- Standard Accessory: 1 x 170mm metal tube (with nozzle) 1 x 300mm flexi hose (with nozzle)



Order Code	Capacity		Pressure	Price
TMLB01	Colour	Bulk filling	Cartridge filling	RM
-10400A	Black	400cc	400g/14oz	4500 99.80

Flexible Nylon Resin Rubber Hoses

- 1/8" BSPT nozzle connections.

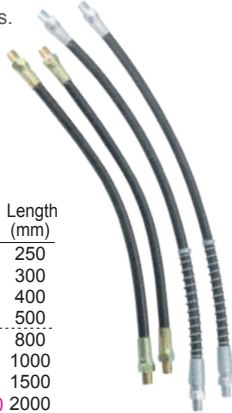

Without Spring		With Spring		Length (mm)
Order Code	Price RM	Order Code	Price RM	
TMLB01		TMLB01		
-90025A	12.50	-	-	250
-90030A	15.00	-90030B	27.20	300
-90040A	18.00	-90040B	37.20	400
-90050A	18.80	-90050B	49.20	500
-90080A	42.60	-90080B	57.70	800
-	-	-90100B	65.40	1000
-	-	-90150B	80.60	1500
-	-	-90200B	118.80	2000

9" Metal Caulking Guns for 310ml Cartridges - Semi-Cylinder Model

- Widely used for sealing joints in industrial, construction and decoration industries

Chrome Plated

- Beautiful, Anti-rust
- Strengthen the structure, upgrade the pressure bar, durable
- Smooth push volume, easy control of injection flow, can effectively save the amount of silica gel

Heavy Duty

- Heavy-duty design, durable and time-saving
- Easy to use, smooth sliding
- Smooth push volume, easy to control the injection flow, can effectively save the amount of silica gel



Order Code	Type	Size	Cartridge (ml)	Price RM
TMTOT01				
-10310A	Stainless steel	9"	310	36.50
-12310A	Heavy Duty	9"	310	79.00

ZP Grease Nipples

- 100Pc / Box



Metric

Order Code	Thread Size	Type	Price RM
TMLB01			
-50060A	M6 x 1	Straight	28.70
-50060B		45°	72.70
-50060C		90°	72.70
-50060D		Button	290.90
-50080A	M8 x 1	Straight	28.70
-50080B		45°	72.70
-50080C		90°	72.70
-50080D		Button	290.90
-50082A	M8 x 1.25	Straight	57.30
-50082B		45°	88.20
-50082C		90°	88.20
-50100A	M10 x 1	Straight	28.70
-50100B		45°	72.70
-50100C		90°	72.70
-50100D		Button	290.90
-50102A	M10 x 1.5	Straight	101.40
-50102B		45°	130.00
-50102C		90°	130.00
-50120A	M12 x 1	Straight	290.90
-50120B		45°	436.40
-50120C		90°	436.40
-50122A	M12 x 1.5	Straight	436.40
-50122B		45°	581.90
-50140A	M14 x 1	Straight	581.90
-50140B		45°	727.40
-50140C		90°	727.40

UNF & NPT

Order Code	Thread Size	Type	Price RM
TMLB01			
-54030A	1/4" - 28 UNF	Straight	44.10
-54030B		45°	88.20
-54030C		90°	88.20
-54033A	5/16" - 24 UNF	Straight	57.30
-54033B		45°	101.40
-54033C		90°	101.40
-54036A	3/8" - 24 UNF	Straight	57.30
-54036B		45°	101.40
-54036C		90°	101.40
-55028A	1/8" - 27 NPT	Straight	57.30
-55028B		45°	101.40
-55028C		90°	101.40
-55030A	1/4" - 18 NPT	Straight	290.90
-55030B		45°	436.40
-55030C		90°	436.40

BSPT

Order Code	Thread Size	Type	Price RM
TMLB01			
-60028A	1/8" - 28 BSPT	Straight	57.30
-60028B		45°	101.40
-60028C		90°	101.40
-60030A	1/4" - 19 BSPT	Straight	290.90
-60030B		45°	436.40
-60030C		90°	436.40

Hydraulic Connectors

- Conical, ZP 4-Jaw, ZP Hook-On, Brass



Order Code	Type	Thread Size	Price RM
TMLB01			
-80100A	Conical-ZP	M10 x 1	260.00 / 100PC
-81028A	4-Jaw-ZP	1/8" - 27 NPT	11.50 / 1PC
-82028C	Hook-on Brass	1/8" - 28 BSPT	34.00 / 1PC

Wood Handled Stainless Steel Scapers

- Heavy-duty flexible Stainless steel blades with 0.7 - 0.8mm thickness.
- Highly polished Stainless Steel blades with composite wooden handle and hanging holes.
- Polished sharp blade for easy removing paint and wall coverings.
- Ergonomic designed provides users with a comfortable grip.



Order Code	Blade Width (mm)	Blade length (mm)	Total Length (mm)	Weight (g)	Price RM
TMTOT06					
-01002A	50	95	200	70	20.80
-01003A	75	105	210	80	23.60
-01004A	100	105	210	80	25.40
-01005A	125	105	210	100	26.30

Industrial Multi-usage Plastic Funnels

- Polyethylene funnel resistant to oil , fuel and some acids, removable flexible spout, anti-splash Rim, , long-lasting.
- Ideal for vehicles or machine with smaller diameter unleaded filler necks.

Red Bevel Mouth



Black Cup



Standard

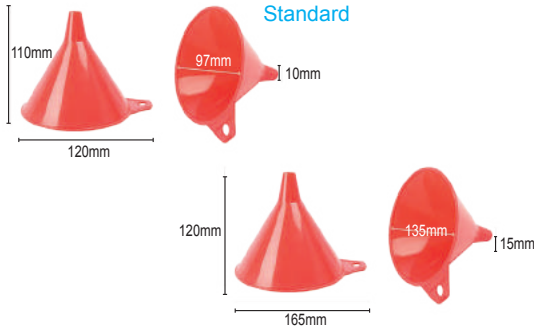

Order Code	Type	Height (mm)	Dia (mm)	Weight (g)	Price RM
TMLB05					
-01165A	Red Bevel Mouth	205	165 x 140	86	28.30
-02145B	Black Cup	185	145	84	11.00
-03097A	Standard	110	97	18	7.50
-03135A	Standard	120	135	26	8.60

Metal Oil Cans

- Seamless metal-bodied oil cans, enamel finish.
- Equipped with both rigid and flexible nylon threaded spout.
- Supplied with force feed valve pump and valve.
- Not for use for Chemicals fluids and grease



Order Code	Capacity (ml)	Weight (g)	Price RM
TMLB01			
-04150A	500	244	27.60

Liquid Measures - Food Grade

- Food grade . Manufactured from high density food grade plastic.
- Moulded handle design , easy-to-read scales for accurate measurement.
- Translucent measuring jug ideal for work place or home use.
- 2.0mm thickwall preventing spillages and leakages.



Order Code	Capacity (ml)	Diameter (mm)	Height (mm)	Price RM
TMOT39				
-01050A	500	98.0	109.0	8.80
-01100A	1000	110.0	145.0	19.00
-01200A	2000	129.0	202.0	21.00
-01300A	3000	166.0	218.0	27.00
-01500A	5000	198.0	255.0	36.00

Wash Bottles with Bent Nozzles - Food Grade

- Food grade . Manufactured from high density food grade plastic.
- Moulded handle design , easy-to-read scales for accurate measurement.
- Translucent measuring jug ideal for work place or home use.
- 2.0mm thickwall preventing spillages and leakages.
- Rigid applicator nozzles fitted with sealing cap prevents leakages.



Order Code	Capacity (ml)	Diameter (mm)	Height (mm)	Price RM
TMOT39				
-05025B	250	21.0	130.3	9.40
-05050B	500	25.0	167.4	14.70
-05100B	1000	25.0	200.0	21.40

Wash Bottles - Food Grade

- Seamless metal-bodied oil cans, enamel finish.
- Equipped with both rigid and flexible nylon threaded spout.
- Supplied with force feed valve pump and valve.
- Not for use for Chemicals fluids and grease



Blue Straight Nozzle

Yellow Lid with Steel Nozzle

Order Code	Type	Capacity (ml)	Bottom Diameter (mm)	Height (mm)	Nozzle length (mm)	Price RM
TMOT39						
-21400A	Blue Straight Nozzle	400	65	160.0	119.0	8.00
-22400C	Yellow Lid with Steel Nozzle	400	65.5	177.0	100.0	12.00

Zinc Alloyed Heavy Duty Auto Loading Trimming Knife

- Ergonomic designed provides users with a comfortable grip.
- High-quality zinc alloy body, strong and durable
- Blade quick change device, auto retractable blade and comfort grip.
- Safety lock device, spare blades can be stored in the handle.
- Quick and easy to change stored spare blades with no tools needed.
- Five spare blades is included.

Order Code	Total Length (mm)	Price RM
TMKN10		
-00004A	187	30.90

Knife Blades

Order Code	Pack Quantity	Price RM
TMKN10		
-90001P	10	8.80



Aluminum Shark Shape Fixed Blade Trimming Knife

- Ergonomic designed provides users with a comfortable grip.
- High-quality zinc alloy body, strong and durable
- Blade quick change device, Screw lock.
- Safety lock device, spare blades can be stored in the handle.
- Quick and easy to change stored spare blades with no tools needed.
- One spare blades is included.

Order Code	Total Length (mm)	Price RM
TMKN10		
-00003A	180	26.60

Knife Blades

Order Code	Pack Quantity	Price RM
TMKN10		
-90001P	10	8.80



Zinc Alloyed Side-open Heavy Duty Auto Trimming Knife

- Ergonomic designed provides users with a comfortable grip.
- High-quality zinc alloy body, strong and durable
- Blade quick change device, auto retractable blade and comfort grip.
- Safety lock device, spare blades can be stored in the handle.
- Quick and easy to change stored spare blades with no tools needed.
- Five spare blades is included.

Order Code	Total Length (mm)	Price RM
TMKN10		
-00005A	177	28.70

Knife Blades

Order Code	Pack Quantity	Price RM
TMKN10		
-90001P	10	8.80



Fixed Blade Trimming Knife

- High-quality zinc alloy blade, strong and durable
- The blade automatically rebounds, safe and convenient
- High-quality high-carbon steel blade, sharp and durable
- Five spare blades is included.

Order Code	Total Length (mm)	Price RM
TMKN10		
-00007A	133	16.30

Knife Blades

Order Code	Pack Quantity	Price RM
TMKN10		
-90001P	10	8.80



Professional Auto Return Trimming Knife

- High-quality zinc alloy blade, strong and durable
- The blade automatically rebounds, safe and convenient
- High-quality high-carbon steel blade, sharp and durable

Order Code	specification (mm)	Price RM
TMKN17		
-00001R	155 x 32	

Knife Blades

Order Code	Pack Quantity	Price RM
TMKN10		
-90001P	10	8.80



Professional Heavy Duty Trimming Knife

- High-quality zinc alloy blade, strong and durable
- The blade automatically rebounds, safe and convenient
- Blade adopts SK5 blade, sharp and durable
- Safety lock device

Order Code	specification (mm)	Price RM
TMKN10		
-00002A	155 x 35	35.50

Knife Blades

Order Code	Pack Quantity	Price RM
TMKN10		
-90001P	10	8.80



5Pc Telescopic Magnetic Pick-Up & Inspection Mirror Kit

- Stainless Steel Rod, EVA mould, tools neatly organised.
- Kit includes:
1 x 8lb (3.6kg) Pick up tool
1 x 8lb (3.6kg) Telescopic Pick up tool
1 x 3-1/2lb (1.6kg) Pick Up Head
1 x 3-1/2" x 2" (90 x 50mm) Flexible Inspection Mirror.
1 x 1-1/4" (32mm) Circular Inspection Mirror.



Order Code	Pack Quantity	Price RM
TMOT10	5	279.90
-16452K		

Claw Ended Crowbars

- Forged high quality manganese steel
- Surface spray treatment, anti-rust and dirt
- For dismantling and nail lifter dual use, easy to use and smart



Order Code	Length (mm)	Width (mm)	Weight (mm)	Price RM
TMHT02				
-00450A	450	16	800	36.80
-00600A	600	16	1040	43.20
-00750A	750	16	1270	48.60
-00900A	900	16	1500	59.80

Punch & Chisel Sets

- Made of High-quality chrome vanadium steel
- Specially hardened blade, strong and durable
- The moderate hardness of the handle, can effectively reduce the vibration, easy to manipulate
- Golden surface, exquisite appearance, rust resistance
- Metl case packing, light and strong, easy to store

6Pc Punch & Chisel Set

- Flat Chisel:
15 x 12 x 150mm
12 x 10 x 130mm
- Pin Punch:
3 x 10 x 150mm
5 x 12 x 150mm
- Center Punch:
4 x 10 x 120mm
- Taper Punch:
4 x 10 x 120mm



Order Code	Pieces	Price RM
TMPC88	6	73.50
-00206T		

6Pc Punch Set

- Center Punch:
3 x 10 x 150mm
5 x 10 x 150mm
8 x 12 x 150mm
- Taper Punch:
3 x 10 x 150mm
5 x 10 x 150mm
8 x 12 x 150mm

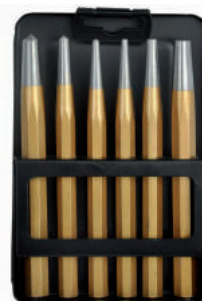

Order Code	Pieces	Price RM
TMPC88	6	73.50
-00406T		

6Pc Pin Punch Set

- Pin Punch:
3 x 10 x 150mm
4 x 10 x 150mm
5 x 10 x 150mm
6 x 10 x 150mm
7 x 12 x 150mm
8 x 12 x 150mm



Order Code	Pieces	Price RM
TMPC88	6	73.50
-00506T		

14Pc Punch & Chisel Set

- Flat Chisel:
12.7 x 9.5 x 151mm, 16 x 12.7 x 178mm
19 x 16 x 178mm, 22 x 16 x 200mm, 25 x 19 x 216mm
- Pin Punch: 3 x 9.5 x 127mm
- Center Punch:
3 x 9.5 x 127mm
2.4 x 9.5 x 127mm
4.8 x 9.5 x 150mm
6 x 12.7 x 150mm
- Taper Punch:
3 x 9.5 x 216mm
3 x 12.7 x 250mm
4 x 12.7 x 229mm
9.5 x 16 x 250mm



Order Code	Pieces	Price RM
TMPC88	14	236.30
-00114T		

6Pc Punch & Chisel Set

- Flat Chisel: 15 x 12 x 150mm
12 x 10 x 130mm
- Cross Cut Chisel: 5 x 10 x 130mm
- Pin Punch: 5 x 12 x 150mm
- Center Punch: 3 x 10 x 120mm
- Taper Punch: 4 x 10 x 120mm



Order Code	Pieces	Price RM
TMPC88	6	73.50
-00306T		

Flexible Pick Up Tool with LED Light

- Freely bent, magnetic, with one LED light
- Strongly absorbs small iron items



Order Code	Size (mm)	Price RM
TMOT10		
-10010L	571	33.60

Flexible Inspection Mirror

- Flexible shaft design can be applied to more workplaces, especially suitable for narrow spaces

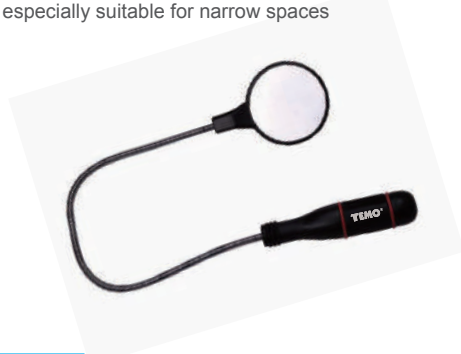

Order Code	Mirror Size (mm)	Overall Length (mm)	Price RM
TMOT11			
-10050D	50	450	19.10

Torch Type Telescopic Pick Up Tool

- Aluminum alloy body, durable, anti-corrosion
- Torch light & pick up tool 2-in-1, convenient and practical
- Flexible suction rod head, can be set to any angle
- 6 strong light LED beads, Strong pick-up tool
- Powered by 4 x LR44 batteries



Order Code	Torchlight Length(mm)	Extended Length(mm)	Weight (g)	Price RM
TMOT10				
-40001T	180	708	134	46.60

Telescopic Pick Up Tool

- 4 sections designed to enable the product to be used in more workplaces suitable for various job requirements
- Telescopic rods are easy to carry and use



Order Code	Closed Length (mm)	Extended Length (mm)	Diameter of Outer Tube (mm)	Price RM
TMOT10				
-30010A	177	580	8.0	12.10

LED Flexible Inspection Mirror

- Flexible shaft design, can be bent and twisted freely to suit various working situations
- LED lighting further expands the use of tools



Order Code	Mirror Size (mm)	Overall Length (mm)	Price RM
TMOT10			
-10020D	50 x 80	575	65.20

Pen Type Magnetic Pick Up Tool

- Used to pick up fasteners, parts and other small objects
- Extension rods can reach places that are often difficult to reach



Order Code	Head Diameter (mm)	Extended Length (mm)	Lifting Capacity (kg)	Price RM
TMOT10				
-20010P	10	635	1.5	13.00
-20013P	13	635	3.0	14.70

Internal & External Spring Calipers

- External Spring Caliper: Used to measure outer dimensions such as outer diameter, thickness and width
- Internal Spring calipers: Used to measure internal hole diameter such as internal diameter, groove dimension

Internal Caliper		External Calipers		Capacity
Order Code	Price RM	Order Code	Price RM	
TMOT02		TMOT02		
-10075A	59.00	-20075B	59.00	75mm / 3"
-10100A	46.70	-20100B	46.70	100mm / 4"
-10125A	49.20	-20125B	49.20	125mm / 5"
-10150A	59.00	-20150B	59.00	150mm / 6"
-10200A	73.70	-20200B	73.70	200mm / 8"
-10250A	88.50	-20250B	88.50	250mm / 10"
-10300A	98.30	-20300B	98.30	300mm / 12"
-10400A	127.80	-20400B	127.80	400mm / 16"
-10500A	157.40	-20500B	157.40	500mm / 20"
-10600A	182.00	-20600B	182.00	600mm / 24"
-10800A	565.50	-20800B	565.50	800mm / 32"
-11000A	663.90	-21000B	663.90	1000mm / 40"



Magnetic Plastic Bowl

- Made of high density plastic materials, moulded designed.
- Magnetic Bowl can hold small hard ware parts such as bolts or screws in the garage, workshop, shed, prevent them lost.
- Using these magnetic bowls, will improve your working efficiency.
- PVC bottom prevent from scratching.

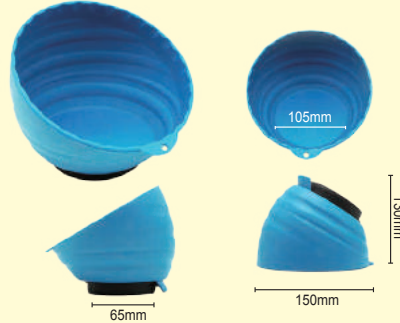

Order Code	Bowl Dia (mm)	Bottom Dia (mm)	Height (mm)	Price RM
TMOT10				
-03150B	150	105	130	50.30

Spring Dividers

- Made of high carbon steel
- Suitable for scribing arcs and circles on steel workpiece hardness below HRC22
- It can also be used on leather, wood but not on paper

Order Code	Capacity	Price RM
TMOT02		
-40100A	100mm / 4"	46.70
-40125A	125mm / 5"	49.20
-40150A	150mm / 6"	59.00
-40200A	200mm / 8"	73.70
-40250A	250mm / 10"	88.50
-40300A	300mm / 12"	98.30
-40400A	400mm / 16"	127.80
-40500A	500mm / 20"	157.40
-40600A	600mm / 24"	182.00
-40800A	800mm / 32"	565.50
-41000A	1000mm / 40"	663.90



Zeiss High Definition Magnifier for Metal Identification

- Made of High-quality Aluminium alloy body, strong and durable (Phosphate surface)
- Made of 2 high precision objective lenses, ergonomically designed.



Order Code	Magnification	Diameter (mm)	Price RM
TMOT04			
-04030A	x30	ø43 x 30mm	43.00

Jewellers Eye Loupe

- Made of High-quality ABS plastic materials
- Made of 2 high density ayctic lenses, ergonomically designed.



Order Code	Magnification	Diameter (mm)	Price RM
TMOT04			
-04110A	x10	ø50 x 48mm	19.50

Jewellers Eye Loupe

- Well constructed with high quality ABS plastic and a surface without sharp edges.
- Perfect for jeweler's checking hallmarks and anything close up. UV functions.
- Silver eye magnifying glass in metal plated case
- Light powered by 3 x LR1130 batteries (Excluded)



Order Code	Magnification	Lens Diameter (mm)	Size (mm)		Weight (g)	Price RM
			Opening	Folding		
TMOT04						
-04240A	x40	25	105 x 30 x 28	62 x 30 x 28	192	42.90

Carpenters Dividers

- Made of high carbon steel
- Winged pen cover, can be installed pencil or scriber
- Applicable materials: steel, plastic, wood and leather

Order Code	Capacity	Price RM
TMOT02		
-50100A	100mm / 4"	56.50
-50125A	125mm / 5"	59.00
-50150A	150mm / 6"	73.70
-50200A	200mm / 8"	88.50
-50250A	250mm / 10"	98.30
-50300A	300mm / 12"	108.20
-50400A	400mm / 16"	137.60
-50500A	500mm / 20"	196.70
-50600A	600mm / 24"	221.30
-50800A	800mm / 32"	614.70
-51000A	1000mm / 40"	688.40



3 LED Double Lense Hand-held Magnifier

- Deluxe high power magnifications magnifier suitable for reading , high precision viewing , etc.
- Well constructed with high quality ABS plastic and a surface without sharp edges.
- Comes With 3 Energy-efficient Bright White LED Lights
- LED Lamps With On /Off Switch, Ideal for Night Reading Assistance in Low-light Conditions.
- Batteries: 3 x7 batteries (not included)



Order Code	Large lens Magnifications	Small lens Magnifications	Large lens Dia(mm)	Small lens Dia(mm)	Total Length (mm)	Handle Length (mm)	Weight (g)	Price RM
TMOT04								
-03103A	x3	x45	75	22	190	110	120	39.00

12 LED Hand-held Magnifier with Aluminum Alloyed Handle

- Made of High-quality Aluminium alloy body, strong and durable , equipped with acylic lense.
- Portable magnifier with 12 LED lights to illuminate in low light conditions, to read in the dark
- Well constructed with high quality ABS plastic and a surface without sharp edges.
- Power Magnification: This magnifying glass equipped double glass Lenses, provide 10X magnification effect, would help someone with low vision see better.
- 12 LED Lamps With On /Off Switch for first press, followed by 6 LED Lamps with second On/Off.
- Battery: 2*AA batteries(not included)



Order Code	Front lens Magnifications	Back lens Magnifications	Front Lens Dia.(mm)	Back Lens Dia.(mm)	Total Length (mm)	Weight (g)	Price RM
TMOT04							
-03205A	x5	x10	85	20	240	267	92.00

Full Optical Lense Scaled LED Magnifier

- The lens of this magnifying glass is made of high-quality optical glass, equipped with 3 LED ligh bulbs.
- Made of High-quality Aluminium alloy body, strong and durable.
- Battery: 2*AA batteries(not included)



Order Code	Magnifications	Lens Dia. (mm)	Size (mm)	Weight (g)	Price RM
TMOT04					
-03710A	x10	25	180 x 58 x 48	150	109.00

Black Double LED Foldable Magnifier

- Suitable for inspecting paper , photographs, printed documents etc.
- Self-standing for free hand and foldable for easy storage.
- Made of high quality optical lenses, LED lights.
- Battery: 3*LR927 button batteries(included)

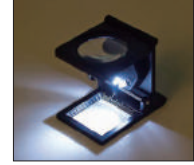

Order Code	Magnifications	Lens Dia. (mm)	Size (mm)	Weight (G)	Price RM
TMOT04					
-09010A	x10	28	56 x 48 x 50	106	43.00

3 LED Head Loup with Interchangeable Lenses - USB Charging

- Deluxe high power magnifications magnifier suitable for reading , high precision viewing , etc.
- Made of High-quality ABS materials. Equipped with 6 interchangeable lenses with 3: 1magnification working distance.
- USB charging.
- Adjustable side pivots allow the visor to tilt at your fingertips, controls for adjusting the light beam.
- Multiple magnification 8x power.
- Batteries life - 6 to 12 hours
- Lightweight multiple acrylic coated lenses for comfort.



Order Code	Front lens Magnifications	Back lens Magnifications	Focus Magnifications (mm)	Size (mm)	Weight (g)	Price RM
TMOT04						
-03831A	31	x1.5	x1, x1.5, x2, x2.5, x3	35 - 500	295 x 212 x 60	238 199.00

6 LED Bench Magnifier

- Made of High-quality ABS materials with flexible hose length permits viewing at any angle , broad-base designed provides stability grip.
- Combination of acylic and optical lenses.
- 6 LED Input power. ed lenses for comfort.



Order Code	Magnifications	Focus Magnifications (mm)	Power Input (V)	Diamensions (mm)	Weight (g)	Price RM
TMOT04						
-01108A	x8	210	110 - 240	320 x 168 x 300	1320	202.50

Insulated Combination Pliers



- Specially quenching heat-treated cutting edges with hardness up to HRC55 - 62
- Strong clamping, super strong cutting force, durable
- Conforms to VDE-GS EN 60900 standards.



Order Code	Size	Weight (g)	Price RM
TMNS10			
-20150A	6"(150mm)	240	133.60
-20180A	7"(180mm)	290	145.60
-20200A	8"(200mm)	410	163.30

Insulated Diagonal Pliers



- Specially quenching heat-treated cutting edges with hardness up to HRC55 - 62
- The cutting surfaces are precise and smooth, the cutting edge is sharp, and the sealing is complete. super strong cutting force, durable
- Conforms to VDE-GS EN 60900 standards.



Order Code	Size	Weight (g)	Price RM
TMNS12			
-20150A	6"(150mm)	230	140.70
-20180A	7"(180mm)	300	153.80

Insulated Wire Stripping Pliers



- The jaws are specially quenching heat-treated, strong and durable
- Variable adjustable of stripping diameter, convenient and efficient, does not hurt the wire
- Conforms to VDE-GS EN 60900 standards.



Order Code	Size	Price RM
TMNS18		
-20150A	6"(150mm)	140.70

Insulated Water Pump Pliers



- The jaws are specially quenching heat-treated, strong and durable
- Adjust the opening width directly on the workpiece, safe and convenient
- Self-locking when clamping, non-slip, effortless
- IEC 60900:2004
- DIN EN 60900:2004



Order Code	Size	Price RM
TMNS20		
-20250A	10"(250mm)	195.00

Insulated Long Nose Pliers



- Specially quenching heat-treated cutting edges with hardness up to HRC55 - 62
- The pliers jaw is closed tightly, firmly clamped, super strong cutting force, durable
- Conforms to VDE-GS EN 60900 standards.



Order Code	Size	Weight (g)	Price RM
TMNS11			
-20150A	6"(150mm)	170	138.10
-20200A	8"(200mm)	250	150.20

Insulated H/D Diagonal Cutting Pliers



- Specially quenching heat-treated cutting edges with hardness up to HRC55 - 62
- Longer cutting surfaces are precise and flat, with sharp cutting edges and perfect sealing. Stronger cutting force, easier for heavy duty operation, stronger and durable
- Conforms to VDE-GS EN 60900 standards.



Order Code	Size	Weight (g)	Price RM
TMNS12			
-21150H	6"(150mm)	205	153.80
-21180H	7"(180mm)	280	162.20
-21200H	8"(200mm)	290	175.30

Insulated Adjustable Wrenches



- Manufactured from High-quality chrome vanadium steel



Order Code	Size	Price RM
TMNS08		
-10200A	8"(200mm)	274.30
-10250A	10"(250mm)	333.90

Insulated Electrician Shears



- High quality stainless steel blade



A Type

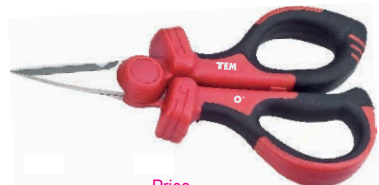

B Type

Order Code	Style	Size	Price RM
TMNS55			
-10140A	A	160mm	128.60
-10140B	B	160mm	128.60

Insulated Cable Knife - Straight Blade



- High quality stainless steel blade



Order Code	Blade length	Size	Weight	Price RM
TMNS50				
-12001A	2"(50mm)	8"(200mm)	100g	72.00

Insulated Cable Knife - Hook Blade



- High quality stainless steel blade



Order Code	Blade length	Size	Weight	Price RM
TMNS50				
-12003H	2"(50mm)	8"(200mm)	100g	238.50

Insulated Cable Stripping Knife



- High quality stainless steel blade



Order Code	Blade length	Size	Weight	Price RM
TMNS50				
-11002A	2"(50mm)	8"(200mm)	100g	62.00

Insulated Electrician's Knife - Curved Blade



- High quality stainless steel blade



Order Code	Blade length	Size	Weight	Price RM
TMNS50				
-12002B	2"(50mm)	8"(200mm)	100g	72.00

Insulated Cable Stripping Knife - Dagger Blade



- High quality stainless steel blade



Order Code	Blade length	Size	Weight	Price RM
TMNS50				
-11001A	2"(50mm)	8"(200mm)	100g	62.00

Insulated Interchangeable Blade Cable Knife



- High quality stainless steel blade



Order Code	Blade length	Size	Weight	Price RM	Order Code	Size	Price RM
TMNS50					TMNS50		
-12004C	2"(50mm)	8"(200mm)	70g	72.00	-90004P	4 pc / Pack	120.30

Mains Tester



- Made in Germany



Order Code	Measuring range	Blade length	Overall length	Price RM
TMNS70				
-01250A	125~250V	105mm	190mm	46.70

Insulated VDE Spanners



- Chrome vanadium single ended open jaw spanners, industrial grade, fully insulated.
- VDE certified



Size (mm)	Single End Open Jaw			Single End Ring Spanners		
	Order Code	Length (mm)	Price RM	Order Code	Length (mm)	Price RM
7	-20507A	95	97.00	-20607A	125	101.40
8	-20508A	95	73.30	-20608A	125	104.50
9	-20509A	105	100.10	-20609A	125	106.90
10	-20510A	105	74.80	-20610A	125	96.90
11	-20511A	125	102.50	-20611A	130	107.30
12	-20512A	125	76.70	-20612A	130	98.70
13	-20513A	140	104.90	-20613A	145	110.20
14	-20514A	140	78.20	-20614A	145	100.30
15	-20515A	140	113.10	-20615A	155	116.20
16	-20516A	160	116.80	-20616A	155	120.10
17	-20517A	160	83.50	-20617A	155	105.60
18	-20518A	170	127.40	-20618A	170	132.20
19	-20519A	170	93.80	-20619A	170	115.80
20	-20520A	170	151.40	-20620A	170	157.80
21	-20521A	195	158.00	-20621A	190	163.10
22	-20522A	195	110.40	-20622A	190	132.50
23	-20523A	220	173.50	-20623A	215	189.10
24	-20524A	220	125.00	-20624A	215	147.00
25	-20525A	220	238.90	-20625A	215	244.20
26	-20526A	240	247.50	-20626A	230	253.30
27	-20527A	240	169.50	-20627A	230	191.50
28	-20528A	240	275.50	-20628A	230	298.00
29	-20529A	260	284.30	-20629A	255	309.00
30	-20530A	260	194.00	-20630A	255	216.00
31	-20531A	275	310.80	-20631A	265	342.50
32	-20532A	275	213.60	-20632A	265	235.60

16Pc 3/8" Dr. Insulation Socket Set

- Products include:
 - 1 piece 3/8" Dr. ratchet handle: 200mm
 - 1 piece 3/8" Dr. sliding T-handle: 200mm
 - 1 each 3/8" Dr. extension bar: 150, 250mm
 - 4 piece 3/8" Dr. x 60mm (L) Hex socket bits: 4, 5, 6, 8mm
 - 8 piece 3/8" Dr. sockets: 8, 10, 12, 13,14, 17, 19, 22mm



Order Code	Size	Price RM
TMNS88		
-12016T	3/8"	2596.90

20Pc 1/2" Dr. Insulation Socket Set

- Products include:
 - 1 piece 1/2" Dr. ratchet handle: 250mm
 - 1 piece 1/2" Dr. sliding T-handle: 200mm
 - 2 piece 1/2" Dr. extension bar: 125, 250mm
 - 5 piece 1/2" Dr. x 120mm (L) Hex socket bits: 4, 5, 6, 8, 10mm
 - 11 piece 1/2" Dr. sockets: 10, 11, 12, 13, 14, 17, 19, 22, 24, 27, 32mm



Order Code	Size	Price RM
TMNS88		
13120T	1/2"	3216.30

9Pc VDE Insulation Tool Set

- Products include:
 - 1 piece 7"/180mm wire cutters, 1 piece 8"/200mm long nose pliers
 - 1 piece. 6"/150mm diagonal pliers, 1 piece test pen: 120V / 250V
 - 5 piece screwdriver
 - ⊖ Slot: 2.5 × 75mm, 4.0 × 100mm, 5.5 × 125mm
 - ⊕ Cross: PH1 × 80mm, PH2 × 100mm
- VDE test
- Insulation class 1000V
- DIN EN/IEC 60900:2004



Order Code	No. of pieces	Price RM
TMNS88		
-20109T	9	734.80

3Pc VDE Pliers Set

- Products include:
 - 1 piece 7"/180mm wire cutters
 - 1 piece 8"/200mm long nose pliers
 - 1 piece 6"/150mm diagonal pliers
- VDE test, insulation class 1000V
- DIN EN/IEC 60900:2004



Order Code	No. of pieces	Price RM
TMNS88		
-20103T	3	480.90

4Pc VDE Pliers Set

- Products include:
 - 1 piece 7"/180mm wire cutters
 - 1 piece 8"/200mm long nose pliers
 - 1 piece 6"/150mm diagonal pliers
 - 1 piece 6"/150mm wire stripper
- VDE test, insulation class 1000V
- DIN EN/IEC 60900:2004



Order Code	No. of pieces	Price RM
TMNS88		
-20104T	4	647.70

7Pc VDE Insulation Tool Set

- Products include:
 - 1 piece 7"/180mm wire cutters, 1 piece 6"/150mm diagonal pliers
 - 1 test pen: 120V / 250V
 - 4 piece screwdriver
 - ⊖ Slot: 4.0×100mm, 5.5×125mm
 - ⊕ Cross: PH1×80mm, PH2×100mm
- VDE test
- Insulation class 1000V
- DIN EN/IEC 60900:2004



Order Code	No. of pieces	Price RM
TMNS88		
-20107T	7	540.40

10Pc VDE Insulation Tool Set

- Products include:
 - 1 piece 7"/180mm wire cutters
 - 1 piece 6"/150mm diagonal pliers
 - 1 piece test pen: 120V / 250V
 - 7 piece screwdriver:
 - ⊖ Slot: 2.5 × 75mm
 - 3.0 × 100mm, 4.0 × 100mm
 - 5.5 × 125mm
 - ⊕ Cross: PH0 × 60mm, PH1 × 80mm, PH2 × 100mm
- VDE test, insulation class 1000V
- DIN EN/IEC 60900:2004



Order Code	No. of pieces	Price RM	1000V
TMNS88			
-20110T	10	637.10	

11Pc VDE Insulation Tool Set - Zipped Bag

- Products include:
 - 1 piece 7"/180mm wire cutters,
 - 1 piece 8"/200mm long nose pliers
 - 1 pc 6"/150mm diagonal pliers, 1 electrician knife,
 - 1 electrician scissors
 - 1 test pen: 120V / 250V
 - 5 piece screwdriver
 - ⊖ Slot: 2.5 × 75mm
 - 4.0 × 100mm, 5.5 × 125mm
 - ⊕ Cross: PH1 × 80mm, PH2 × 100mm
- VDE test, insulation class 1000V
- DIN EN/IEC 60900:2004



Order Code	No. of pieces	Price RM
TMNS88		
-20111T	11	969.80

19Pc VDE Insulation Tool Set

- Products include:
 - 1 piece 7"/180mm wire cutters, 1 piece 8"/200mm long nose pliers
 - 1 pcs 6"/150mm diagonal pliers, 1 pc. 6"/150mm wire stripper
 - 1 test pen: 120V / 250V, 2 roll insulation tape
 - 4 red key handles
 - (Square hole: 6 x 00mm; square hole: 8 x 100mm; Triangle hole: 9 x 100mm; Round hole: 5.3 x 100mm)
 - 8 piece screwdriver:
 - ⊖ Slot:
 - 2.5 × 75mm, 3.0 × 100mm
 - 4.0 × 100mm, 5.5 × 125mm
 - 6.5 × 150mm, 8.5 × 175mm
 - ⊕ Cross: PH0 × 60mm, PH1 × 80mm
- VDE test, insulation class 1000V
- DIN EN/IEC 60900:2004



Order Code	No. of pieces	Price RM
TMNS88		
-20119A	19	1150.30

7Pc VDE Insulated Screwdriver Sets



I Type



II Type



III Type



IV Type

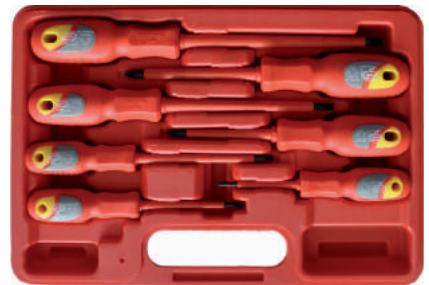

Order Code	Type	Products include	Price RM
TMNS88			
-21107T	I Type	⊖ Slot: 4.0×100mm, 5.5×125mm, 6.5×150mm ⊕ Cross: PH0×60mm, PH1×80mm, PH2×100mm 1 test pen: 120V / 250V	246.60
-21207T	II Type	⊖ Slot: 3.5×75mm, 4.0×100mm, 5.5×125mm, 6.5×150mm	238.20
-21307T	III Type	⊖ Slot: 3.5×75mm, 4.0×100mm, 5.5×125mm, 6.5×150mm	155.80
-21407T	IV Type	⊖ Slot: 3.5×75mm, 4.0×100mm, 5.5×125mm, 6.5×150mm	177.00

Safety Tools

- Suitable for flammable and explosive environments, including petroleum and liquefied gas, petrochemical, gunpowder, chemical, winery, spray booth operation, gas pipeline, leather processing, electric power, military, pharmaceutical, ship, tank, aerospace, mining and other kinds of flammable and explosive working environment
- Explosion-proof tools are made of Be-Bronze and Al-Bronze aluminum bronze materials with special characteristics of high mechanical strength and no sparking due to frictional impact
- Aluminum bronze: hardness: HRC20-30, tensile strength: $\sigma b75-85kgf/mm^2$
- Beryllium bronze: hardness: HRC30-40, tensile strength: $\sigma b105-120kgf/mm^2$
- Beryllium bronze has stronger torque and hardness than aluminum bronze. Suitable for use in places where explosion-proof safety levels are demanding
- Phosphorus bronze: lower hardness than beryllium bronze, good fatigue resistance, can be used for electrical and mechanical materials, higher reliability than ordinary copper alloy products

Safety Combination Pliers



Length (mm)	Beryllium Bronze			Aluminum Bronze		
	Order Code TMSF10	Weight (g)	Price RM	Order Code TMSF10	Weight (g)	Price RM
150	-00150B	180	557.40	-00150A	165	319.40
175	-00175B	355	679.70	-00175A	330	397.20
200	-00200B	465	758.60	-00200A	435	431.90
250	-00250B	550	938.60	-00250A	500	540.40

Safety Snipe Nose Pliers



Length (mm)	Beryllium Bronze			Aluminum Bronze		
	Order Code TMSF11	Weight (g)	Price RM	Order Code TMSF11	Weight (g)	Price RM
150	-00150B	190	569.30	-00150A	170	336.10
200	-00200B	335	680.00	-00200A	300	401.50

Safety Diagonal Nose Pliers



Length (mm)	Beryllium Bronze			Aluminum Bronze		
	Order Code TMSF12	Weight (g)	Price RM	Order Code TMSF12	Weight (g)	Price RM
150	-00150B	245	617.80	-00150A	225	349.50
200	-00200B	410	679.10	-00200A	365	391.40

Safety Flat Nose Pliers



Length (mm)	Beryllium Bronze			Aluminum Bronze		
	Order Code TMSF14	Weight (g)	Price RM	Order Code TMSF14	Weight (g)	Price RM
150	-00150B	165	618.00	-00150A	151	360.80
200	-00200B	281	752.50	-00200A	257	426.30

Safety Slotted Screwdrivers



Blade Size (mm)	Overall Length (mm)	Beryllium Bronze			Aluminum Bronze			
		Order Code TMSF30	Weight (g)	Price RM	Order Code TMSF30	Weight (g)	Price RM	
3	50	134	-10010B	35	81.40	-10010A	33	54.10
4.5	50	134	-10020B	43	96.30	-10020A	40	59.30
3	75	159	-10030B	35	98.50	-10030A	32	60.50
4	75	159	-10040B	45	103.20	-10040A	42	68.20
5	75	180	-10050B	70	112.60	-10050A	65	70.20
4	100	184	-10060B	45	121.80	-10060A	42	73.80
5	100	205	-10070B	75	128.40	-10070A	70	78.20
6	100	215	-10080B	85	133.40	-10080A	80	82.30
6	125	240	-10090B	100	140.70	-10090A	95	92.40
6	150	265	-10100B	110	173.80	-10100A	105	105.50
7	150	265	-10110B	125	178.40	-10110A	120	110.40
8	150	277	-10120B	140	185.90	-10120A	135	116.40
8	200	327	-10130B	165	211.50	-10130A	155	129.80
9	250	377	-10140B	185	279.90	-10140A	175	169.90
11	250	377	-10150B	260	293.90	-10150A	245	182.00
10	300	427	-10160B	245	341.20	-10160A	230	206.00
11	300	427	-10170B	290	360.60	-10170A	275	218.10
11	350	477	-10180B	320	431.00	-10180A	300	260.70
12	400	550	-10190B	450	493.50	-10190A	430	298.10

Safety Phillips Screwdrivers



Blade Size	Overall Length (mm)	Beryllium Bronze			Aluminum Bronze			
		Order Code TMSF31	Weight (g)	Price RM	Order Code TMSF31	Weight (g)	Price RM	
PH0	50	134	-11010B	35	87.40	-11010A	32	54.90
PH1	75	159	-11020B	70	100.00	-11020A	63	63.90
PH1	100	205	-11030B	75	119.00	-11030A	70	76.50
PH2	125	240	-11040B	100	146.80	-11040A	95	94.30
PH2	150	265	-11050B	110	178.50	-11050A	105	110.10
PH3	200	327	-11060B	165	214.70	-11060A	155	129.80
PH3	250	377	-11070B	185	292.70	-11070A	170	177.10
PH4	300	427	-11080B	245	347.30	-11080A	230	210.60
PH4	350	477	-11090B	270	433.30	-11090A	255	264.10
PH4	400	550	-11100B	295	504.20	-11100A	280	303.80
PH4	450	600	-11110B	320	528.80	-11110A	300	322.70

Safety Adjustable Wrenches



Length (mm)	Jaw Opening (mm)	Beryllium Bronze			Aluminum Bronze		
		Order Code TMSF59	Weight (g)	Price RM	Order Code TMSF59	Weight (g)	Price RM
100	13	-10100B	33	427.40	-10100A	30	218.80
150	18	-10150B	135	495.20	-10150A	120	281.00
200	24	-10200B	281	588.60	-10200A	255	378.10
250	30	-10250B	440	707.00	-10250A	401	469.40
300	36	-10300B	720	995.70	-10300A	655	607.60
375	46	-10375B	1410	1414.00	-10375A	1290	935.10
450	55	-10450B	2261	1923.10	-10450A	2065	1197.60
600	65	-10600B	4705	3461.10	-10600A	4301	2086.40

Safety Open Ended Slogging Wrenches



Size (mm)	Length (mm)	Beryllium Bronze			Aluminum Bronze		
		Order Code TMSF60	Weight (g)	Price RM	Order Code TMSF60	Weight (g)	Price RM
17	125	-10017B	150	250.50	-10017A	135	146.70
18	125	-10018B	150	257.70	-10018A	135	154.20
19	125	-10019B	150	267.90	-10019A	135	160.80
22	135	-10022B	195	283.30	-10022A	175	169.80
24	150	-10024B	245	320.40	-10024A	220	180.40
27	165	-10027B	335	398.50	-10027A	300	259.50
28	175	-10028B	385	463.40	-10028A	350	283.40
30	180	-10030B	435	502.40	-10030A	390	303.70
32	190	-10032B	515	580.20	-10032A	460	351.40
36	210	-10036B	725	689.90	-10036A	655	422.30
41	230	-10041B	955	892.40	-10041A	860	570.00
46	240	-10046B	1225	1064.20	-10046A	1100	730.30
50	255	-10050B	1560	1222.10	-10050A	1420	870.00
55	272	-10055B	1850	1470.10	-10055A	1680	1054.50
56	305	-10056B	2025	1605.10	-10056A	1830	1103.60
60	290	-10060B	2190	1797.90	-10060A	1970	1182.70
63	335	-10063B	3060	1990.10	-10063A	2780	1215.40
65	307	-10065B	3060	2180.10	-10065A	2780	1194.70
70	325	-10070B	4030	2694.20	-10070A	3660	1658.50
75	343	-10075B	4200	2909.30	-10075A	3800	1789.90
76	375	-10076B	4660	3135.20	-10076A	4030	1928.90
80	360	-10080B	5650	3793.90	-10080A	5130	2334.20
85	380	-10085B	6000	4304.10	-10085A	5400	2648.20
90	400	-10090B	7800	4973.80	-10090A	7050	3060.30
95	400	-10095B	7730	5816.20	-10095A	7000	3578.40
100	430	-10100B	11600	6726.80	-10100A	10500	4138.70
110	465	-10110B	13500	7788.10	-10110A	12000	4791.80
120	530	-10120B	17358	9022.90	-10120A	15780	5551.40
130	560	-10130B	19700	10005.00	-10130A	17910	6155.70
140	630	-10140B	25560	11207.90	-10140A	23236	6895.80
150	630	-10150B	25560	12180.80	-10150A	23236	7494.30

Safety Ring Slogging Wrenches



Size (mm)	Length (mm)	Beryllium Bronze			Aluminum Bronze		
		Order Code TMSF61	Weight (g)	Price RM	Order Code TMSF61	Weight (g)	Price RM
17	165	-10017B	210	236.30	-10017A	190	143.80
19	165	-10019B	200	287.70	-10019A	180	156.90
22	165	-10022B	245	302.00	-10022A	220	164.80
24	165	-10024B	235	304.80	-10024A	210	191.10
27	175	-10027B	350	399.10	-10027A	315	226.00
30	185	-10030B	475	458.50	-10030A	430	300.80
32	185	-10032B	465	566.00	-10032A	420	366.50
34	200	-10034B	540	620.30	-10034A	490	399.10
36	200	-10036B	580	673.90	-10036A	520	429.70
38	215	-10038B	680	801.30	-10038A	620	484.40
41	225	-10041B	755	987.00	-10041A	680	653.10
46	235	-10046B	990	1112.00	-10046A	890	741.60
50	250	-10050B	1145	1293.10	-10050A	1030	870.70
55	265	-10055B	1440	1543.00	-10055A	1300	1048.60
60	274	-10060B	1620	1664.20	-10060A	1450	1103.30
65	298	-10065B	1995	1795.40	-10065A	1800	1195.20
70	320	-10070B	2435	2035.50	-10070A	2200	1354.10
75	326	-10075B	3010	2201.20	-10075A	2710	1465.20
80	350	-10080B	3600	2574.90	-10080A	3250	1685.90
85	355	-10085B	4330	3027.40	-10085A	3915	1966.30
90	390	-10090B	5200	3532.40	-10090A	4700	2268.20
95	390	-10095B	5450	4009.30	-10095A	4920	2553.10
100	420	-10100B	6750	4723.60	-10100A	6100	2732.70
105	420	-10105B	7000	5069.80	-10105A	6320	3186.30
110	450	-10110B	9130	6314.40	-10110A	8250	3884.90
120	480	-10120B	11000	7743.50	-10120A	9930	4764.20
130	510	-10130B	12610	8639.30	-10130A	11400	5307.10
140	520	-10140B	13000	9453.60	-10140A	11750	5816.50
150	565	-10150B	14500	10311.40	-10150A	13100	6570.50

Safety Double Open Ended Spanners



Size (mm)	Length (mm)	Beryllium Bronze			Aluminum Bronze		
		Order Code TMSF51	Weight (g)	Price RM	Order Code TMSF51	Weight (g)	Price RM
5.5 x 7	90	-10010B	23	57.40	-10010A	20	32.30
6 x 7	92	-10020B	25	60.70	-10020A	22	34.20
8 x 9	98	-10030B	28	71.90	-10030A	25	41.40
9 x 10	105	-10040B	34	81.40	-10040A	31	47.40
10 x 11	115	-10050B	52	92.00	-10050A	47	52.40
10 x 12	120	-10060B	60	96.10	-10060A	55	55.40
11 x 13	126	-10070B	68	96.70	-10070A	62	55.90
12 x 13	128	-10080B	73	104.30	-10080A	67	59.60
12 x 14	130	-10090B	75	105.70	-10090A	69	62.20
13 x 17	140	-10100B	110	120.30	-10100A	100	69.30
14 x 15	143	-10110B	115	135.30	-10110A	105	77.80

Continue next page...

Safety Double Open Ended Spanners

...continued from previous page		Beryllium Bronze			Aluminum Bronze		
Size (mm)	Length (mm)	Order Code TMSF51	Weight (g)	Price RM	Order Code TMSF51	Weight (g)	Price RM
14 × 17	150	-10120B	120	147.90	-10120A	110	84.90
16 × 17	157	-10130B	130	157.40	-10130A	120	90.40
17 × 19	170	-10140B	150	168.80	-10140A	135	96.20
18 × 19	179	-10150B	200	224.30	-10150A	180	128.70
19 × 21	182	-10160B	210	234.30	-10160A	190	134.50
19 × 22	185	-10170B	220	241.00	-10170A	200	138.60
19 × 24	190	-10180B	235	270.90	-10180A	210	155.60
20 × 22	195	-10190B	250	285.10	-10190A	225	164.10
21 × 23	200	-10200B	270	303.00	-10200A	235	174.00
22 × 24	210	-10210B	312	308.90	-10210A	285	178.30
24 × 26	225	-10220B	330	303.00	-10220A	302	174.00
24 × 27	230	-10230B	345	421.10	-10230A	310	252.20
24 × 30	233	-10240B	365	503.50	-10240A	330	290.50
25 × 28	236	-10250B	365	580.60	-10250A	330	335.40
27 × 30	250	-10260B	485	648.40	-10260A	430	373.60
27 × 32	255	-10270B	600	705.30	-10270A	549	406.10
30 × 32	265	-10280B	610	719.10	-10280A	540	414.60
30 × 36	270	-10290B	815	817.30	-10290A	730	471.20
32 × 36	290	-10300B	885	875.60	-10300A	800	515.80
36 × 41	335	-10310B	1350	1110.90	-10310A	1210	690.40
41 × 46	355	-10320B	1590	1396.10	-10320A	1430	998.50
46 × 50	370	-10330B	2050	1685.60	-10330A	1850	971.90
50 × 55	385	-10340B	2160	1879.20	-10340A	1950	1086.40
50 × 60	400	-10350B	2488	2137.20	-10350A	2275	1252.90
55 × 60	415	-10360B	2700	2445.40	-10360A	2450	1271.60
60 × 65	435	-10370B	3950	2760.90	-10370A	3600	1594.40
65 × 70	460	-10380B	4540	3116.00	-10380A	4150	1935.60

Safety Single Open Jaw Spanners



Size (mm)	Length (mm)	Beryllium Bronze			Aluminum Bronze		
		Order Code TMSF50	Weight (g)	Price RM	Order Code TMSF50	Weight (g)	Price RM
8	95	-10008B	40	68.40	-10008A	35	35.30
10	100	-10010B	50	93.30	-10010A	45	49.40
12	110	-10012B	65	117.50	-10012A	60	63.40
14	140	-10014B	95	147.20	-10014A	85	75.90
17	160	-10017B	105	182.00	-10017A	95	93.80
19	170	-10019B	130	226.80	-10019A	115	117.00
22	195	-10022B	170	304.90	-10022A	152	159.70
24	220	-10024B	190	378.20	-10024A	170	208.10
27	240	-10027B	285	473.20	-10027A	260	267.60
30	260	-10030B	320	585.50	-10030A	290	306.70
32	275	-10032B	400	644.00	-10032A	365	356.80
34	290	-10034B	455	645.50	-10034A	410	394.30
36	310	-10036B	530	701.60	-10036A	480	425.50
41	345	-10041B	615	833.10	-10041A	555	480.50
46	375	-10046B	950	1046.40	-10046A	860	505.30
50	410	-10050B	1080	1217.10	-10050A	950	623.20
55	450	-10055B	1380	1267.00	-10055A	1200	864.10
60	490	-10060B	1950	1668.40	-10060A	1700	1048.00
65	530	-10065B	2250	2094.90	-10065A	2000	1307.80
70	570	-10070B	2850	2524.80	-10070A	2550	1538.90
75	610	-10075B	3200	2650.90	-10075A	2800	1609.40

Safety Combination Spanners



Size (mm)	Length (mm)	Beryllium Bronze			Aluminum Bronze		
		Order Code TMSF52	Weight (g)	Price RM	Order Code TMSF52	Weight (g)	Price RM
6	105	-10006B	22	85.40	-10006A	20	48.90
7	105	-10007B	37	97.20	-10007A	34	54.10
8	120	-10008B	37	109.50	-10008A	34	63.20
9	120	-10009B	55	124.10	-10009A	50	71.40
10	135	-10010B	55	156.70	-10010A	50	90.60
11	135	-10011B	75	190.30	-10011A	75	105.70
12	150	-10012B	75	203.90	-10012A	70	117.70
13	150	-10013B	122	225.30	-10013A	110	134.90
14	175	-10014B	122	264.20	-10014A	110	152.40
15	175	-10015B	160	291.10	-10015A	145	169.40
16	195	-10016B	155	319.90	-10016A	140	188.20
17	195	-10017B	155	338.80	-10017A	140	197.20
18	215	-10018B	210	355.30	-10018A	190	207.20
19	215	-10019B	210	363.30	-10019A	190	213.00
20	230	-10020B	225	385.10	-10020A	200	223.30
21	230	-10021B	225	426.90	-10021A	200	249.20
22	245	-10022B	250	443.80	-10022A	220	258.80
23	245	-10023B	265	484.90	-10023A	232	282.20
24	265	-10024B	260	519.70	-10024A	230	298.00
25	265	-10025B	260	583.00	-10025A	230	342.20
26	290	-10026B	420	651.10	-10026A	380	382.10
27	290	-10027B	420	744.00	-10027A	380	436.30
30	320	-10030B	560	902.90	-10030A	500	519.20
32	340	-10032B	670	998.60	-10032A	600	603.50
34	360	-10034B	850	1168.60	-10034A	750	700.90
35	360	-10035B	890	1262.60	-10035A	800	732.60
36	360	-10036B	890	1382.30	-10036A	800	787.00
38	430	-10038B	1440	1482.50	-10038A	1300	856.40
41	430	-10041B	1440	1752.50	-10041A	1300	1041.00
46	480	-10046B	1890	2045.10	-10046A	1700	1181.40
50	520	-10050B	2220	2183.10	-10050A	2000	1261.20
55	560	-10055B	2460	2394.60	-10055A	2230	1383.30
60	595	-10060B	3300	2588.60	-10060A	2950	1495.40
65	595	-10065B	3250	2840.40	-10065A	2900	1640.80
70	630	-10070B	4550	3180.60	-10070A	4100	1844.60

Safety Double Ring Ended Spanners



Size (mm)	Length (mm)	Beryllium Bronze			Aluminum Bronze		
		Order Code TMSF53	Weight (g)	Price RM	Order Code TMSF53	Weight (g)	Price RM
6 × 7	115	-10010B	22	64.30	-10010A	20	35.00
7 × 9	130	-10020B	25	73.60	-10020A	23	40.10
8 × 10	130	-10030B	50	84.10	-10030A	46	45.80
9 × 11	140	-10040B	55	96.70	-10040A	50	52.60
10 × 12	140	-10050B	70	106.20	-10050A	65	57.80
11 × 13	160	-10060B	80	117.00	-10060A	75	63.70

Continue next page...

Safety Double Ring Ended Spanners



...continued from previous page

Size (mm)	Length (mm)	Beryllium Bronze			Aluminum Bronze		
		Order Code TMSF53	Weight (g)	Price RM	Order Code TMSF53	Weight (g)	Price RM
14 × 15	200	-10070B	85	156.30	-10070A	78	91.90
16 × 17	220	-10080B	120	174.50	-10080A	110	105.80
17 × 19	250	-10090B	151	197.70	-10090A	140	120.10
19 × 21	280	-10100B	205	258.00	-10100A	180	151.30
19 × 22	280	-10110B	220	271.70	-10110A	202	154.20
19 × 24	310	-10120B	225	315.00	-10120A	205	173.50
20 × 22	280	-10130B	290	352.30	-10130A	265	192.60
21 × 23	285	-10140B	295	364.40	-10140A	270	198.60
22 × 24	310	-10150B	310	392.40	-10150A	280	214.40
22 × 27	340	-10160B	355	401.00	-10160A	320	219.20
23 × 26	340	-10170B	405	404.90	-10170A	360	222.50
24 × 26	340	-10180B	450	411.20	-10180A	410	226.50
24 × 30	350	-10190B	455	523.60	-10190A	415	286.50
25 × 28	350	-10200B	520	571.60	-10200A	475	317.40
26 × 32	370	-10210B	550	617.10	-10210A	501	339.20
27 × 30	360	-10220B	580	688.90	-10220A	530	378.90
27 × 32	380	-10230B	640	748.50	-10230A	570	415.70
29 × 32	380	-10240B	705	768.30	-10240A	645	431.00
32 × 34	400	-10250B	805	1028.90	-10250A	736	577.30
32 × 35	405	-10260B	1050	1056.60	-10260A	960	590.00
32 × 36	405	-10270B	1080	1095.00	-10270A	980	618.40
34 × 36	420	-10280B	1145	1121.90	-10280A	1030	652.40

Safety Single Ring Jaw Spanners



Size (mm)	Length (mm)	Beryllium Bronze			Aluminum Bronze		
		Order Code TMSF55	Weight (g)	Price RM	Order Code TMSF55	Weight (g)	Price RM
8	110	-10008B	40	124.80	-10008A	35	75.40
10	120	-10010B	50	196.30	-10010A	45	117.90
12	130	-10012B	65	281.70	-10012A	60	168.20
14	140	-10014B	90	368.90	-10014A	80	199.80
17	155	-10017B	105	391.40	-10017A	90	218.30
19	170	-10019B	130	442.10	-10019A	95	227.80
22	190	-10022B	175	572.70	-10022A	150	293.60
24	215	-10024B	220	635.20	-10024A	200	355.60
27	230	-10027B	270	768.30	-10027A	245	418.40
30	255	-10030B	370	843.70	-10030A	335	499.30
32	265	-10032B	425	1019.40	-10032A	385	600.60
36	295	-10036B	550	1268.10	-10036A	500	747.80
41	330	-10041B	825	1363.30	-10041A	750	914.30
46	365	-10046B	1120	1581.00	-10046A	1010	1071.40
50	400	-10050B	1270	1919.20	-10050A	1150	1132.50
55	445	-10055B	1590	2026.10	-10055A	1440	1195.40
60	474	-10060B	1850	2183.50	-10060A	1680	1286.30
65	510	-10065B	2060	2470.00	-10065A	1875	1457.80
70	555	-10070B	2530	2599.30	-10070A	2300	1532.90
75	590	-10075B	2700	2843.40	-10075A	2450	1676.20

Safety Open Ended Podger Spanners



Length (mm)	Jaw Opening (mm)	Beryllium Bronze			Aluminum Bronze		
		Order Code TMSF57	Weight (g)	Price RM	Order Code TMSF57	Weight (g)	Price RM
17	220	-20017B	125	224.40	-20017A	115	137.80
19	240	-20019B	160	239.50	-20019A	145	140.40
22	260	-20022B	210	324.10	-20022A	190	202.60
24	280	-20024B	265	388.30	-20024A	240	227.50
27	300	-20027B	350	477.50	-20027A	315	279.80
30	320	-20030B	445	589.80	-20030A	405	345.60
32	340	-20032B	530	708.50	-20032A	480	415.30
36	360	-20036B	720	765.00	-20036A	650	448.30
41	380	-20041B	1010	1063.10	-20041A	910	661.90
46	400	-20046B	1115	1141.60	-20046A	1010	711.90
50	420	-20050B	1165	1255.80	-20050A	1055	789.40
55	450	-20055B	1485	1407.90	-20055A	1345	876.10
60	480	-20060B	2015	1823.40	-20060A	1825	1149.80

Safety Double-Socket Podger Spanners

- Forging products
- 1 wrench can be used for 2 types of bolts



Size (mm)	Overall Length (mm)	Beryllium Bronze			Aluminum Bronze		
		Order Code TMSF48	Weight (g)	Price RM	Order Code TMSF48	Weight (g)	Price RM
14 & 17	280	-01417B	410	1523.90	-01417A	370	869.40
17 & 19	310	-01719B	450	1598.50	-01719A	410	922.40
19 & 22	345	-01922B	530	1646.90	-01922A	480	962.10
22 & 24	365	-02224B	680	1833.70	-02224A	620	1011.90
24 & 27	380	-02427B	860	1920.90	-02427A	780	1059.20
27 & 30	400	-02730B	990	1993.20	-02730A	900	1100.50
30 & 32	400	-03032B	1025	2067.10	-03032A	930	1142.40
32 & 36	450	-03236B	1450	2240.80	-03236A	1300	1236.70
36 & 41	495	-03641B	1860	2434.20	-03641A	1690	1400.80

Safety Multi-purpose Wrenches

- European design for opening and locking of different drum lids
- Precision casting products



L (mm)	S1 (mm)	S2 (mm)	Beryllium Bronze			Aluminum Bronze		
			Order Code TMSF57	Weight (g)	Price RM	Order Code TMSF57	Weight (g)	Price RM
300	38	52	-00300B	830	900.20	-00300A	750	528.20

Safety Hook Spanners

- Forging products
- For tightening or disassembling round nuts on machine tools, vehicles, and mechanical equipment
- DIN German standard9, 22mm

Fixed Type



Size (mm)	Overall Length (mm)	Beryllium Bronze			Aluminum Bronze		
		Order Code TMSF58	Weight (g)	Price RM	Order Code TMSF58	Weight (g)	Price RM
30 - 32	140	-10032B	63	331.50	-10032A	50	199.40
34 - 36	170	-10036B	95	385.70	-10036A	85	229.70
40 - 42	176	-10042B	105	497.90	-10042A	95	305.40
45 - 50	209	-10050B	160	580.20	-10050A	145	351.00
52 - 55	212	-10055B	170	662.90	-10055A	150	398.70
58 - 62	244	-10062B	225	698.80	-10062A	200	442.70
68 - 75	250	-10075B	265	763.10	-10075A	240	459.10
80 - 90	284	-10090B	375	841.10	-10090A	335	516.80
95 - 100	288	-10100B	415	976.60	-10100A	370	587.60
110 - 115	337	-10115B	770	1049.80	-10115A	690	608.60
120 - 130	343	-10130B	770	1112.70	-10130A	690	651.60
135 - 145	388	-10145B	1110	1297.90	-10145A	1000	760.70

Adjustable Type



Size (mm)	Overall Length (mm)	Beryllium Bronze			Aluminum Bronze		
		Order Code TMSF58	Weight (g)	Price RM	Order Code TMSF58	Weight (g)	Price RM
19 - 50	162	-20050B	120	540.10	-20050A	110	332.30
32 - 75	205	-20075B	260	653.80	-20075A	235	388.60
50 - 120	288	-20120B	515	1037.80	-20120A	460	615.70
115 - 170	310	-20170B	670	1745.50	-20170A	600	1053.60

Pin Type



Size (mm)	Overall Length (mm)	Beryllium Bronze			Aluminum Bronze		
		Order Code TMSF58	Weight (g)	Price RM	Order Code TMSF58	Weight (g)	Price RM
30 - 32	136	-30032B	63	696.20	-30032A	50	423.50
34 - 36	171	-30036B	95	771.50	-30036A	85	474.70
40 - 42	171	-30042B	105	947.10	-30042A	95	574.30
45 - 50	207	-30050B	160	1074.60	-30050A	145	651.30
52 - 55	207	-30055B	170	1140.20	-30055A	150	701.70
58 - 62	243	-30062B	225	1233.10	-30062A	200	751.60
68 - 75	243	-30075B	265	1381.10	-30075A	240	836.90
80 - 90	281	-30090B	375	1573.90	-30090A	335	968.40
95 - 100	281	-30100B	415	1758.40	-30100A	370	1066.20
110 - 115	333	-30115B	770	1923.50	-30115A	690	1167.70

Safety F Spanners

- Fine-casting products
- Head arc design, and the valve contact surface is large, not easy to slip off
- Knurled handle, beautiful and non-slip



Size (mm)	Overall Length (mm)	Beryllium Bronze			Aluminum Bronze		
		Order Code TMSF56	Weight (g)	Price RM	Order Code TMSF56	Weight (g)	Price RM
30	200	-00030B	265	533.10	-00030A	240	277.70
35	250	-00035B	375	597.20	-00035A	340	334.60
40	300	-00040B	450	737.40	-00040A	400	400.20
45	350	-00045B	585	929.10	-00045A	530	477.30
50	400	-00050B	740	999.30	-00050A	670	525.20
55	450	-00055B	830	1233.60	-00055A	750	632.50
60	500	-00060B	1200	1328.20	-00060A	1100	711.60
65	550	-00065B	1280	1513.10	-00065A	1160	810.70
70	600	-00070B	1380	1663.30	-00070A	1250	891.20
75	650	-00075B	1650	1850.10	-00075A	1500	991.80
80	700	-00080B	1870	2013.10	-00080A	1700	1095.40
85	750	-00085B	2090	2342.90	-00085A	1900	1275.40
90	800	-00090B	2310	2586.30	-00090A	2100	1408.00
95	900	-00095B	2980	2799.00	-00095A	2700	1523.10
100	1000	-00100B	3330	3090.80	-00100A	3010	1681.90

Safety Strap Wrenches

- High-strength nylon belt for assembling and disassembling pipe fittings, shaft parts & tubes
- Light weight, can be used in narrow space, non-destructive workpiece surface
- Precision casting



L (mm)	L1 (mm)	B (mm)	Beryllium Bronze			Aluminum Bronze		
			Order Code TMSF58	Weight (g)	Price RM	Order Code TMSF58	Weight (g)	Price RM
300	425	30	-00300B	810	1136.00	-00300A	735	688.10

Safety Ratchet Wrenches



Square Drive	Length (mm)	Beryllium Bronze			Aluminum Bronze		
		Order Code TMSF47	Weight (g)	Price RM	Order Code TMSF47	Weight (g)	Price RM
3/8"	200	-20200B	290	609.30	-20200A	260	358.90
1/2"	245	-30245B	690	1015.90	-30245A	615	568.80
3/4"	320	-40320B	1570	2034.70	-40320A	1430	1141.80
1"	550	-50550B	3400	3710.40	-50550A	3070	2067.10

Safety Sockets



1/4" Square Drive		Beryllium Bronze			Aluminum Bronze		
Size (mm)	Length (mm)	Order Code TMSF40	Weight (g)	Price RM	Order Code TMSF40	Weight (g)	Price RM
4	25	-11040B	17	105.20	-11040A	15	61.20
4.5	25	-11045B	17	105.50	-11045A	15	61.50
5	25	-11050B	17	105.70	-11050A	15	62.00
5.5	25	-11055B	17	112.70	-11055A	15	66.80
6	25	-11060B	17	123.10	-11060A	15	72.50
7	25	-11070B	17	131.70	-11070A	15	78.20
8	25	-11080B	17	140.40	-11080A	15	82.40
9	25	-11090B	21	150.90	-11090A	20	89.60
10	25	-11100B	22	209.70	-11100A	20	123.80
11	25	-11110B	27	220.20	-11110A	25	138.00
12	26	-11120B	30	232.30	-11120A	27	138.00
13	26	-11130B	30	244.40	-11130A	27	153.60

3/8" Square Drive		Beryllium Bronze			Aluminum Bronze		
Size (mm)	Length (mm)	Order Code TMSF40	Weight (g)	Price RM	Order Code TMSF40	Weight (g)	Price RM
6	28	-12060B	35	130.30	-12060A	32	77.00
7	28	-12070B	35	139.40	-12070A	32	82.90
8	28	-12080B	35	148.10	-12080A	32	88.80
9	28	-12090B	35	175.60	-12090A	32	105.50
10	32	-12100B	50	225.80	-12100A	45	129.10
11	32	-12110B	50	236.90	-12110A	45	144.60
12	32	-12120B	50	252.70	-12120A	45	144.60
13	32	-12130B	50	266.00	-12130A	45	160.40
14	32	-12140B	50	281.70	-12140A	45	160.40
15	32	-12150B	53	286.30	-12150A	48	176.30
16	32	-12160B	58	295.00	-12160A	53	176.30
17	32	-12170B	63	309.60	-12170A	57	176.30
19	32	-12190B	68	326.40	-12190A	62	186.10
20	32	-12200B	77	341.00	-12200A	70	208.80

1/2" Square Drive		Beryllium Bronze			Aluminum Bronze		
Size (mm)	Length (mm)	Order Code TMSF40	Weight (g)	Price RM	Order Code TMSF40	Weight (g)	Price RM
10	40	-13100B	78	250.10	-13100A	71	141.20
11	40	-13110B	79	256.30	-13110A	72	151.80
12	40	-13120B	79	268.90	-13120A	72	151.80
13	40	-13130B	80	281.40	-13130A	73	165.60
14	40	-13140B	80	293.40	-13140A	73	165.60
15	40	-13150B	82	298.90	-13150A	75	188.60
16	40	-13160B	85	322.60	-13160A	77	188.60
17	40	-13170B	88	333.90	-13170A	80	188.60
18	42	-13180B	90	346.90	-13180A	82	205.30
19	42	-13190B	110	363.80	-13190A	100	205.30
20	42	-13200B	120	384.10	-13200A	105	220.00
21	43	-13210B	125	394.00	-13210A	110	220.00
22	43	-13220B	130	403.50	-13220A	115	220.00

Continue on right column...

...continued from left column

1/2" Square Drive		Beryllium Bronze			Aluminum Bronze		
Size (mm)	Length (mm)	Order Code TMSF40	Weight (g)	Price RM	Order Code TMSF40	Weight (g)	Price RM
23	43	-13230B	150	441.50	-13230A	135	259.50
24	43	-13240B	165	479.50	-13240A	145	259.50
25	43	-13250B	180	524.60	-13250A	160	321.60
26	43	-13260B	200	555.40	-13260A	180	321.60
27	46	-13270B	215	588.60	-13270A	190	321.60
28	46	-13280B	225	621.90	-13280A	200	381.80
29	46	-13290B	235	662.20	-13290A	210	381.80
30	46	-13300B	250	705.00	-13300A	220	381.80
32	46	-13320B	295	788.10	-13320A	260	421.20

3/4" Square Drive		Beryllium Bronze			Aluminum Bronze		
Size (mm)	Length (mm)	Order Code TMSF40	Weight (g)	Price RM	Order Code TMSF40	Weight (g)	Price RM
17	50	-14170B	246	420.70	-14170A	225	234.70
19	50	-14190B	246	423.80	-14190A	225	242.20
21	55	-14210B	268	465.70	-14210A	245	262.80
22	55	-14220B	268	477.00	-14220A	245	262.80
23	55	-14230B	306	489.50	-14230A	280	294.60
24	55	-14240B	307	530.10	-14240A	280	294.60
26	55	-14260B	307	613.70	-14260A	280	362.10
27	55	-14270B	312	652.00	-14270A	285	362.10
28	55	-14280B	339	682.90	-14280A	310	429.60
29	55	-14290B	350	728.30	-14290A	320	429.60
30	60	-14300B	410	773.60	-14300A	370	429.60
31	60	-14310B	430	821.50	-14310A	380	483.70
32	60	-14320B	465	869.20	-14320A	410	483.70
34	60	-14340B	480	938.50	-14340A	440	559.30
36	60	-14360B	510	1005.30	-14360A	465	559.30
38	60	-14380B	555	1074.60	-14380A	510	657.90
41	65	-14410B	660	1182.10	-14410A	640	657.90
46	65	-14460B	765	1397.00	-14460A	690	777.20
50	70	-14500B	910	1530.70	-14500A	825	852.70

Safety Universal Joints



Square Drive		Beryllium Bronze			Aluminum Bronze		
Length (mm)	Order Code TMSF41	Weight (g)	Price RM	Order Code TMSF41	Weight (g)	Price RM	
1/2"	80	-30010B	186	315.00	-30010A	170	203.10
3/4"	110	-40010B	530	816.30	-40010A	480	491.30

Safety Extensions



Square Drive		Beryllium Bronze			Aluminum Bronze		
Length (mm)	Order Code TMSF43	Weight (g)	Price RM	Order Code TMSF43	Weight (g)	Price RM	
3/8"	75	-20075B	93	202.10	-20075A	80	123.30
3/8"	150	-20150B	185	289.30	-20150A	160	174.50
1/2"	100	-30100B	245	352.10	-30100A	225	213.10
1/2"	125	-30125B	260	371.90	-30125A	230	226.50
1/2"	200	-30200B	365	506.00	-30200A	330	304.20
1/2"	250	-30250B	470	532.70	-30250A	425	320.30
3/4"	200	-40200B	855	766.50	-40200A	770	453.40
1"	200	-50200B	1525	1151.30	-50200A	1380	677.10

Safety Sliding T-Handles



Square Drive	Length (mm)	Beryllium Bronze			Aluminum Bronze		
		Order Code TMSF46	Weight (g)	Price RM	Order Code TMSF46	Weight (g)	Price RM
1/2"	250	-30250B	340	628.30	-30250A	310	373.40
3/4"	350	-40350B	1070	1025.20	-40350A	960	609.30
3/4"	400	-40400B	1335	1245.80	-40400A	1221	740.40
1"	400	-50400B	1620	1469.90	-50400A	1481	874.90

Safety Offset Handles



Square Drive	Length (mm)	Height (mm)	Beryllium Bronze			Aluminum Bronze		
			Order Code TMSF44	Weight (g)	Price RM	Order Code TMSF44	Weight (g)	Price RM
3/8"	200	50	-20200B	314	349.60	-20200A	287	220.60
1/2"	230	60	-30230B	410	452.20	-30230A	380	283.40
3/4"	280	75	-40280B	765	823.70	-40280A	699	516.80
1"	300	85	-50300B	1160	1013.80	-50300A	1060	635.30

Safety Speed Handles



Square Drive	Length (mm)	Height (mm)	Beryllium Bronze			Aluminum Bronze		
			Order Code TMSF45	Weight (g)	Price RM	Order Code TMSF45	Weight (g)	Price RM
1/2"	390	96	-30390B	780	610.10	-30390A	700	365.60

T-Handled Hex Wrenches



Size (mm)	Overall Length (mm)	Beryllium Bronze			Aluminum Bronze		
		Order Code TMSF49	Weight (g)	Price RM	Order Code TMSF49	Weight (g)	Price RM
2	100	-20020B	55	339.40	-20020A	50	213.90
3	100	-20030B	55	354.90	-20030A	50	222.50
4	100	-20040B	75	370.30	-20040A	70	232.50
5	100	-20050B	85	385.70	-20050A	75	241.10
6	100	-20060B	100	409.70	-20060A	90	256.90
8	100	-20080B	100	442.40	-20080A	90	278.50
10	100	-20100B	150	473.20	-20100A	135	297.10

Safety Hex Wrenches L Wrenches



Size	Overall Length (mm)	Beryllium Bronze			Aluminum Bronze		
		Order Code TMSF49	Weight (g)	Price RM	Order Code TMSF49	Weight (g)	Price RM
2	50	-00020B	3	222.80	-00020A	2	136.70
3	63	-00030B	5	245.20	-00030A	4	150.30
4	70	-00040B	12	253.80	-00040A	11	155.60
5	80	-00050B	22	258.90	-00050A	20	158.80
6	90	-00060B	30	272.50	-00060A	27	167.20
7	95	-00070B	50	286.30	-00070A	45	175.60
8	100	-00080B	56	298.30	-00080A	50	182.90
9	106	-00090B	85	312.00	-00090A	77	191.30
10	112	-00100B	100	324.00	-00100A	90	198.70
11	118	-00110B	140	351.40	-00110A	126	215.60
12	125	-00120B	162	382.30	-00120A	145	234.40

L Ball Drivers



Size	Overall Length (mm)	Beryllium Bronze			Aluminum Bronze		
		Order Code TMSF49	Weight (g)	Price RM	Order Code TMSF49	Weight (g)	Price RM
2	50	-10020B	3	258.70	-10020A	2	158.60
3	63	-10030B	5	282.30	-10030A	4	173.10
4	70	-10040B	12	293.10	-10040A	11	179.70
5	80	-10050B	22	299.60	-10050A	20	183.70
6	90	-10060B	30	314.60	-10060A	27	193.00
7	95	-10070B	50	331.90	-10070A	45	203.60
8	100	-10080B	56	344.90	-10080A	51	211.50
9	106	-10090B	85	359.90	-10090A	76	220.70
10	112	-10100B	100	370.70	-10100A	90	227.40
11	118	-10110B	140	407.30	-10110A	125	249.70
12	125	-10120B	175	441.90	-10120A	160	271.00

Safety Water Pump Pliers



Length (mm)	Beryllium Bronze			Aluminum Bronze		
	Order Code TMSF20	Weight (g)	Price RM	Order Code TMSF20	Weight (g)	Price RM
150	-00150B	180	506.60	-00150A	160	296.20
250	-00250B	425	922.00	-00250A	370	543.20
300	-00300B	670	1205.10	-00300A	600	711.20
350	-00350B	850	1347.40	-00350A	770	796.10

Safety Pipe Wrenches



Length (mm)	Jaw Opening (mm)	Beryllium Bronze		Aluminum Bronze			
		Order Code TMSF25	Weight (g)	Price RM	Order Code TMSF25	Weight (g)	Price RM
200	25	-00200B	380	573.70	-00200A	345	340.20
250	30	-00250B	580	693.00	-00250A	500	445.20
300	40	-00300B	750	853.20	-00300A	680	567.10
350	50	-00350B	1100	1029.60	-00350A	1000	681.70
450	60	-00450B	1785	1663.60	-00450A	1625	1044.10
600	75	-00600B	3255	2499.20	-00600A	2960	1573.80
900	85	-00900B	6035	4855.50	-00900A	5490	2964.30
1200	110	-01200B	12280	7834.20	-01200A	10870	4635.80

Safety End Type Pipe Wrenches



Length (mm)	Jaw Opening (mm)	Beryllium Bronze		Aluminum Bronze			
		Order Code TMSF25	Weight (g)	Price RM	Order Code TMSF25	Weight (g)	Price RM
200	34	-11200B	560	561.80	-11200A	510	343.30
250	48	-11250B	930	907.00	-11250A	840	566.80
300	50	-11300B	1470	1471.60	-11300A	1330	901.50
375	60	-11375B	1780	1780.70	-11375A	1610	1076.80
450	76	-11450B	2650	2650.20	-11450A	2400	1617.20

Safety Offset Pipe Wrenches



Length (mm)	Jaw Opening (mm)	Beryllium Bronze		Aluminum Bronze			
		Order Code TMSF25	Weight (g)	Price RM	Order Code TMSF25	Weight (g)	Price RM
200	34	-12200B	500	574.10	-12200A	450	347.00
250	48	-12250B	850	849.80	-12250A	780	519.70
300	50	-12300B	1200	1199.70	-12300A	1090	732.10
375	60	-12375B	1950	1948.40	-12375A	1770	1163.20
450	76	-12450B	2730	2700.40	-12450A	2480	1655.00

Safety Hex Pipe Wrenches



Length (mm)	Jaw Opening (mm)	Beryllium Bronze		Aluminum Bronze			
		Order Code TMSF25	Weight (g)	Price RM	Order Code TMSF25	Weight (g)	Price RM
250	30	-13250B	1250	1249.40	-13250A	1130	761.10
350	50	-13350B	1785	1746.20	-13350A	1620	1075.90

Safety Offset Handle Hex Pipe Wrenches



Length (mm)	Jaw Opening (mm)	Beryllium Bronze		Aluminum Bronze			
		Order Code TMSF25	Weight (g)	Price RM	Order Code TMSF25	Weight (g)	Price RM
250	30	-14250B	1250	1249.40	-14250A	1130	761.10
350	50	-14350B	1785	1746.20	-14350A	1620	1075.90

Safety Rapid Grip Pipe Wrenches

- Forging products
- For holding, assembling and disassembling pipe fittings, shaft parts & tubes One-hand operation, convenient and quick



Length (mm)	Jaw Opening (mm)	Beryllium Bronze		Aluminum Bronze			
		Order Code TMSF25	Weight (g)	Price RM	Order Code TMSF25	Weight (g)	Price RM
250	48	-15250B	980	996.90	-15250A	880	642.40
350	60	-15350B	1900	1873.70	-15350A	1710	1121.00

Light Duty Safety Chain Wrenches

- For clamping, assembling and disassembling pipe fittings, shaft parts & tubes, light and durable especially suitable for narrow spaces
- Precision casting

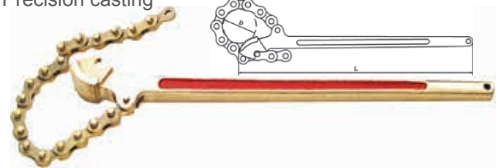

Order Code TMSF26	Length (mm)	Max Chain Capacity (mm)	Weight (kg)	Price RM
-10100A	600	100	2.1	1979.50
-10450A	1600	450	10.5	6144.10

Safety Chain Wrenches

- For fastening and dismantling larger metal tubes and cylindrical parts
- Die forging



Order Code TMSF26	Length (mm)	Max Chain Capacity (mm)	Weight (kg)	Price RM
-20100A	600	100	4.0	2336.70
-20150A	600	150	4.7	2538.30
-20200A	900	200	8.6	4386.90
-20300A	900	300	9.8	4611.10

Safety Flat Files

- Suitable for flammable and explosive occasions Boring and trimming the surface, recesses and bores of metal workpieces
- Die forging

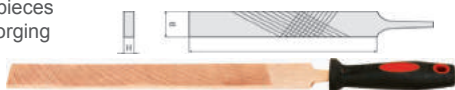

L (inch)	L (mm)	B (mm)	H (mm)	Weight (g)	Beryllium Bronze	
					Order Code	Price RM
6	150	16	4.0	75	-00150B	394.50
8	200	21	4.5	160	-00200B	477.80
10	250	25	6.0	282	-00250B	548.20
12	300	30	6.5	455	-00300B	859.40
14	350	32	8.0	675	-00350B	1273.70
16	400	32	9.5	925	-00400B	1490.60

Safety Rust Scrapers

- Forging products
- Suitable for removing rust, dirt, etc.
- Long handle design makes work easier



Blade Length (mm)	Blade Width (mm)	Overall Length (mm)	Beryllium Bronze			Aluminum Bronze		
			Order Code	Weight (g)	Price RM	Order Code	Weight (g)	Price RM
200	30	325	-01200B	330	390.90	-01200A	300	235.60
300	30	430	-01300B	480	511.60	-01300A	440	308.40
350	35	490	-01350B	640	606.50	-01350A	580	365.60
350	50	500	-01351B	1020	775.30	-01351A	910	467.30
400	60	560	-01400B	1520	1115.60	-01400A	1330	672.50

Safety Triangle Scrapers

- Precision casting products
- Suitable for scraping the edges of oil grooves and holes on the workpiece



Blade Length (mm)	Blade Width (mm)	Overall Length (mm)	Beryllium Bronze			Aluminum Bronze		
			Order Code	Weight (g)	Price RM	Order Code	Weight (g)	Price RM
160	22	300	-11160B	245	303.40	-11160A	225	190.50
300	26	400	-11300B	645	719.00	-11300A	590	419.40

Safety Scrapers

- Cold rolled products
- Suitable for scraping putty, derusting, etc.
- Plastic handle, better grip



Blade Length (mm)	Blade Width (mm)	Overall Length (mm)	Beryllium Bronze			Aluminum Bronze		
			Order Code	Weight (g)	Price RM	Order Code	Weight (g)	Price RM
25	90	203	-01025B	75	186.20	-01025A	90	112.70
40	90	203	-01040B	95	231.40	-01040A	115	140.30
50	90	203	-01050B	105	287.40	-01050A	120	174.10
65	90	203	-01065B	115	357.50	-01065A	125	216.70

Safety Blot Cutters

- Used for cutting thick metal wire, wire and cable, etc.
- Precision forging



Aluminum Bronze			
Order Code	Length (mm)	Weight (kg)	Price RM
-00600A	600	3.1	1936.80
-00900A	900	8.48	5761.40

Safety Wire Strippers/Bolt Cutters

- Capacity range: 0.5 - 1mm², 1.5 - 2.5mm², 4.0 - 6.0mm²;
- Stripping range: 0.75 - 6.0mm²
- Wire cutting range: M2.6 - M5
- Die forging



Overall Length (mm)	Beryllium Bronze			Aluminum Bronze		
	Order Code	Weight (g)	Price RM	Order Code	Weight (g)	Price RM
200	-00200B	225	838.10	-00200A	205	506.90

Safety Scissors

- Die forging



Overall Length (mm)	Blade Width (mm)	Beryllium Bronze			Aluminum Bronze		
		Order Code	Weight (g)	Price RM	Order Code	Weight (g)	Price RM
150	61	-01150B	110	394.40	-01150A	100	233.20

Safety Tin Snips

- The handle is easy to use, suitable for cutting thin metal sheet
- Die forging



Overall Length (mm)	Blade Width (mm)	Beryllium Bronze			Aluminum Bronze		
		Order Code	Weight (g)	Price RM	Order Code	Weight (g)	Price RM
300	75	-02300B	488	864.30	-02300A	410	510.70

Safety Scissors - Easy Cut

- Long cutting edge makes it easier to cut thin metal sheets
- Die forging



Overall Length (mm)	Blade Width (mm)	Beryllium Bronze			Aluminum Bronze		
		Order Code TMSF75	Weight (g)	Price RM	Order Code TMSF75	Weight (g)	Price RM
290	91	-03290B	235	724.60	-03290A	215	440.20
360	107	-03360B	900	1758.00	-03360A	823	1053.20

Safety Bent Blade Snips

- Circular cutting edge, especially suitable for cutting linear objects
- Die forging

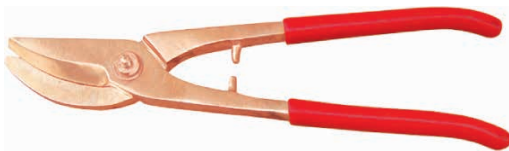

Overall Length (mm)	Beryllium Bronze			Aluminum Bronze		
	Order Code TMSF75	Weight (g)	Price RM	Order Code TMSF75	Weight (g)	Price RM
280	-04280B	500	867.20	-04280A	450	526.30

Safety Tailors Scissors

- Used for cutting cloth and thread
- Precision casting



Overall Length (mm)	Blade Width (mm)	Beryllium Bronze			Aluminum Bronze		
		Order Code TMSF75	Weight (g)	Price RM	Order Code TMSF75	Weight (g)	Price RM
225	98	-05225B	245	763.90	-05225A	210	455.90

Safety Stripping Knives

- Cut wire insulation, ropes, etc. in flammable and explosive places
- Cold rolled



Overall Length (mm)	Blade Width (mm)	Beryllium Bronze			Aluminum Bronze		
		Order Code TMSF87	Weight (g)	Price RM	Order Code TMSF87	Weight (g)	Price RM
185	80	-00080B	105	362.00	-00080A	75	254.40
250	145	-00145B	125	416.20	-00145A	95	252.40

Safety Pullers - 2 Jaws

- In addition to the function of a three-jaw puller, non-circular parts can also be disassembled
- Forging die

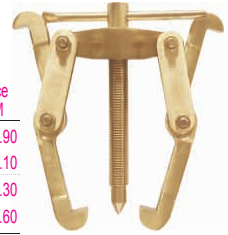

Aluminum Bronze						
Order Code TMSF65	Pull Range (mm)	Pull Depth (mm)	Weight (kg)	Price RM		
-20100A	100	110	1.1	1634.90		
-20150A	150	180	2.2	2038.10		
-20200A	200	260	4.6	2200.30		
-20350A	350	450	8.8	3925.60		

Safety Pullers - 3 Jaws

- Suitable for disassembling bearings, replacing pulleys, and removing various gears, connector and other mechanical parts
- Die forging



Aluminum Bronze						
Order Code TMSF65	Pull Range (mm)	Pull Depth (mm)	Weight (kg)	Price RM		
-30100A	100	110	1.2	2195.80		
-30150A	150	180	2.5	2400.40		
-30200A	200	260	5.2	2674.40		
-30350A	350	450	9.7	5052.80		

Safety Bench Vises with Swivel Bases

- Precision casting

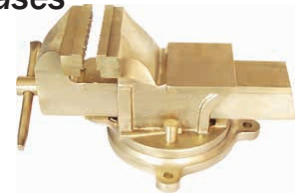

Aluminum Bronze					
Order Code TMSF67	Jaw Width (mm)	Opening (mm)	Weight (kg)	Price RM	
-00090A	90	90	7.4	10055.20	
-00125A	125	125	16.8	20148.90	
-00150A	150	150	26.5	29402.20	
-00170A	170	170	27.4	34168.10	

Safety G Clamps

- Suitable for fitter, metalworking and other operations
- Die forging

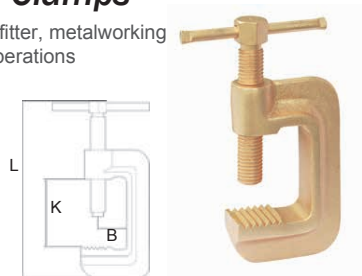

Aluminum Bronze						
Order Code TMSF81	L (mm)	K (mm)	B (mm)	Weight (kg)	Price RM	
-00210A	210	60	36	1.1	518.00	
-00250A	250	80	36	1.3	647.80	
-00290A	290	100	36	1.5	717.10	
-00340A	340	150	50	2.0	875.60	

Safety Hand Pump

- Suitable for pumping gasoline in flammable and explosive working environment oil, diesel, kerosene, edible oil and other oils
- Light weight, easy to suck oil, easy to install and operate, durable
- Precision casting



Aluminum Bronze				
Order Code	Length (mm)	Weight (kg)	Price	
TMSF85			RM	
-01350A	1350	5.7	5267.10	

Safety Funnels

- Used to transfer liquids such as oil into small caliber containers
- Cold rolled



Beryllium Bronze					Aluminum Bronze				
Diameter (mm)	Height (mm)	Weight (g)	Order Code	Price	Order Code	Weight (g)	Price	Order Code	Price
160	130	260	TMSF83	RM	-10130B		240.70		
160	150	280	-10150B				252.70		

Safety Chain Hoists

- Forging products

Standard		Aluminum Bronze				
Capacity (T)	Lift (m)	Order Code	Weight (g)	Price		
0.5	2.5	-00005A	10.2	10391.80		
1.0	2.5	-00010A	13.6	10810.70		
2.0	2.5	-00020A	22.0	15254.50		
3.0	3.0	-00030A	23.6	18703.50		
5.0	3.0	-00050A	36.0	22959.40		
10.0	3.0	-00100A	68.5	57937.80		
16.0	3.0	-00160A	187.0	112011.70		



Safety Wrecking Bars



Beryllium Bronze					Aluminum Bronze				
Length (mm)	Diameter (mm)	Order Code	Weight (g)	Price	Order Code	Weight (g)	Price	Order Code	Price
500	15	-00500B	738	811.10	-00500A	675	486.70		

Safety Wrecking & Pry Bars

- Forging products

Safety D Shackles

- Suitable for flammable and explosive applications, explosion-proof cable buckle used for connecting steel wire rope and chain

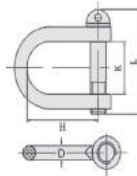

Beryllium Bronze					Aluminum Bronze					
Capacity (N)	D (mm)	K (mm)	L (mm)	H (mm)	Order Code	Weight (g)	Price	Order Code	Weight (g)	Price
2400	1/2	30	60	40	-00030B	135	367.00	-00030A	130	221.20
9940	3/4	37	99	78	-00037B	915	1344.40	-00037A	830	811.30

Chisel & Point Crowbars



Beryllium Bronze					Aluminum Bronze					
Length (mm)	Diameter (mm)	Flat Tail Width (mm)	Order Code	Weight (g)	Price	Order Code	Weight (g)	Price	Order Code	Price
500	15	15	-10500B	672	511.20	-10500A	615	308.00		
500	19	19	-10501B	1093	833.40	-10501A	1001	505.40		
500	20	20	-10502B	1148	869.30	-10502A	1052	527.20		
500	23	23	-10503B	1481	1128.60	-10503A	1355	680.30		
600	25	25	-10600B	2132	1603.10	-10600A	1950	966.30		
800	25	25	-10800B	2530	1889.30	-10800A	2293	1138.90		
1000	30	30	-11000B	5193	4075.90	-11000A	4752	2456.80		

Safety Plumb Bobs

- For vertical baseline when installing equipment in flammable and explosive places,
- Forging

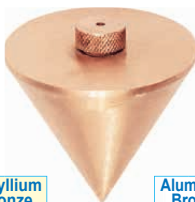

Beryllium Bronze					Aluminum Bronze				
Height (mm)	Diameter (mm)	Order Code	Weight (g)	Price	Order Code	Weight (g)	Price	Order Code	Price
59	50	-20050B	275	258.50	-20050A	247	156.20		

Hexagonal Pry Bars

- Precision casting products

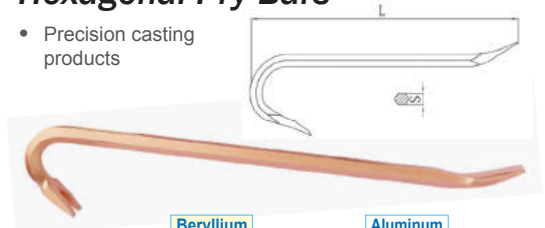

Beryllium Bronze					Aluminum Bronze					
Length (mm)	Diameter (mm)	V-Notch Width (mm)	Order Code	Weight (g)	Price	Order Code	Weight (g)	Price	Order Code	Price
460	162	16	-60460B	890	908.50	-60460A	800	588.50		
760	205	22	-60760B	3100	2499.00	-60760A	2800	1575.40		
920	288	22	-60920B	3650	2776.90	-60920A	3300	1788.80		

Safety Round Mouth Shovels



		Beryllium Bronze			Aluminum Bronze		
Length (mm)	Width (mm)	Order Code TMSF86	Weight (g)	Price RM	Order Code TMSF86	Weight (g)	Price RM
1450	240	-01450B	1553	1649.10	-01450A	1420	923.10

Safety Square Mouth Shovels



		Beryllium Bronze			Aluminum Bronze		
Length (mm)	Width (mm)	Order Code TMSF86	Weight (g)	Price RM	Order Code TMSF86	Weight (g)	Price RM
1390	195	-11390B	3500	2536.90	-11390A	3200	1537.00
1440	175	-11440B	3700	2630.20	-11440A	3480	1604.50

Safety Flat Chisels



		Beryllium Bronze			Aluminum Bronze		
Head Width (mm)	Length (mm)	Order Code TMSF80	Weight (g)	Price RM	Order Code TMSF80	Weight (g)	Price RM
22	150	-01500B	235	289.40	-01500A	205	176.60
22	200	-02000B	320	357.30	-02000A	280	215.30
24	250	-02500B	490	566.60	-02500A	440	353.20
25	300	-03000B	770	859.40	-03000A	700	510.80
27	400	-04000B	1220	1115.30	-04000A	1100	670.00

Safety Pointed Chisels



		Beryllium Bronze			Aluminum Bronze		
Shank Diameter (mm)	Length (mm)	Order Code TMSF81	Weight (g)	Price RM	Order Code TMSF81	Weight (g)	Price RM
18	160	-01600B	290	229.20	-01600A	265	143.70
18	250	-02500B	470	364.40	-02500A	425	228.80
18	300	-03000B	600	447.10	-03000A	545	283.10
20	300	-03001B	700	521.70	-03001A	635	327.50
25	300	-03002B	1100	819.70	-03002A	995	501.10
18	400	-04000B	800	596.20	-04000A	725	368.90
20	400	-04001B	1000	748.30	-04001A	885	469.80

Safety Dividers

- Use in flammable and explosive places for scribing arcs and circles on the workpiece, dividing angles, align centre punch mark, etc
- Die forging



		Beryllium Bronze			Aluminum Bronze		
Dmax (mm)	H (mm)	Order Code TMSF83	Weight (g)	Price RM	Order Code TMSF83	Weight (g)	Price RM
200	200	-00200B	170	840.10	-00200A	150	528.20
400	400	-00400B	400	1711.00	-00400A	360	1075.00

Safety Wheel Brush with Shank - Crimped Wire

- Used for rust removing and oil removal in flammable and explosive places, workpiece or equipment cleaning • Brushed



Phosphorus bronze						
Order Code TMSF84	Diameter (mm)	Height (mm)	Shank diameter (mm)	Weight (g)	Price RM	
-20075C	75	10	6	140	1039.30	

Safety Wheel Brush - Twist Knot Wire

- Used for rust removing and oil removal in flammable and explosive places, workpiece or equipment cleaning • Brushed



Phosphorus bronze						
Order Code TMSF84	Diameter (mm)	Height (mm)	Bore diameter (mm)	Weight (g)	Price RM	
-21125C	125	15	14	440	2075.10	

Safety Cup Brush - Crimped Wire

- Used for rust removing and oil removal in flammable and explosive places, workpiece or equipment cleaning • Brushed



Phosphorus bronze						
Order Code TMSF84	Diameter (mm)	Height (mm)	Bore diameter (mm)	Weight (g)	Price RM	
-25100C	100	30	14	480	1419.10	

Safety Cup Brush - Twist Knot Wire

- Used for rust removing and oil removal in flammable and explosive places, workpiece or equipment cleaning • Brushed



Phosphorus bronze						
Order Code TMSF84	Diameter (mm)	Height (mm)	Bore diameter (mm)	Weight (g)	Price RM	
-26100C	100	30	14	580	2430.90	

Safety Wheel Brush - Crimped Wire

- Used for rust removing and oil removal in flammable and explosive places, workpiece or equipment cleaning • Brushed



Phosphorus bronze						
Order Code TMSF84	Diameter (mm)	Height (mm)	Bore diameter (mm)	Weight (g)	Price RM	
-22125C	125	15	14	320	1618.70	

Safety End Brush - Crimped Wire

- Used for rust removing and oil removal in flammable and explosive places, workpiece or equipment cleaning • Brushed



Phosphorus bronze						
Order Code TMSF84	Diameter (mm)	Shank length (mm)	Shank diameter (mm)	Weight (g)	Price RM	
-28026C	26	30	6	120	631.70	

Wooden Handled Safety Hand Brush

- Used for rust removing and oil removal in flammable and explosive places, workpiece or equipment cleaning
- Brushed



Phosphorus bronze		Copper Wire		Weight (g)	Price RM
Order Code	Length x Width (mm)	height (mm)	Column x Row (mm)		
TMSF84	205 x 48	41	6 x 16	260	440.70
-10106C					

Safety Scrub Brush

- Used for rust removing and oil removal in flammable and explosive places, workpiece or equipment cleaning
- Brushed



Phosphorus bronze		Copper Wire		Weight (g)	Price RM
Order Code	Length x Width (mm)	height (mm)	Column x Row (mm)		
TMSF84	210 x 48	40	6 x 17	500	810.30
-12006C					

Safety Tube Brush

- Used for rust removing and oil removal in flammable and explosive places, workpiece or equipment cleaning
- Brushed



Phosphorus bronze		Overall Length (mm)	Wire Length (mm)	Weight (g)	Price RM
Order Code	Diameter (mm)				
TMSF84	20	320	100	100	560.00
-50320C					

16Pc Safety Packing Tool Set

- Forging products
- Used for pulling and installing packing



Beryllium Bronze			Aluminum Bronze		
Order Code	Weight (g)	Price RM	Order Code	Weight (g)	Price RM
TMSF88	900	8001.90	TMSF88	800	5002.20
-90016B			-90016A		

Safety Torque Wrenches

- Forging products



Square Drive	Torque (Nm)	Length (mm)	Beryllium Bronze		Aluminum Bronze			
			Order Code	Weight (g)	Price RM	Order Code	Weight (g)	Price RM
3/8	100	310	-20100B	600	2130.40	-20100A	540	1284.10
1/2	300	490	-30300B	1340	3442.40	-30300A	1210	2164.90
3/4	500	560	-40500B	2050	4138.50	-40500A	1930	2494.60

9Pc 1/4" Dr. Safety Socket Set - Metric

- 1/4" square explosion-proof spinner handle
- 8-piece 1/4" explosion-proof sockets: 4, 5, 6, 7, 8, 9, 10, 11 (mm)
- Die forging



Aluminum Bronze		Weight (g)	Price RM
Order Code			
TMSF88		0.7	1092.50
-10009A			

10Pc 3/8" Dr. Safety Socket Set - Metric

- 3/8" square explosion-proof ratchet handle: 200mm
- 3/8" square explosion-proof socket extension bar: 75mm
- 7-piece 3/8" square explosion-proof sockets: 10, 11, 12, 13, 14, 17, 19 (mm)
- 13/16" square explosion-proof spark plug socket
- Die forging



Aluminum Bronze		Weight (g)	Price RM
Order Code			
TMSF88		1.7	1950.00
-20010A			

12Pc 1/2" Dr. Safety Socket Set - Metric

- 1/2" square explosion-proof ratchet handle: 245mm
- 1/2" square explosion-proof swivel handle: 250mm
- 10-piece 1/2" square explosion-proof sockets: 8, 10, 11, 12, 14, 17, 19, 22, 24, 27 (mm)
- Die forging



Aluminum Bronze		Weight (g)	Price RM
Order Code			
TMSF88		3.2	3430.70
-30012A			

20Pc 3/4" Dr. Safety Socket Set - Metric

- 3/4" square explosion-proof ratchet handle: 320mm
- 3/4" square explosion-proof sliding T-handle: 400mm
- 3/4" square explosion-proof socket extension bar: 200mm
- 17-piece 3/4" square explosion-proof sockets: 21, 22, 23, 24, 26, 27, 28, 29, 30, 31, 32, 34, 36, 38, 41, 46, 50 (mm)
- Die forging



Aluminum Bronze		Weight (g)	Price RM
Order Code			
TMSF88		14.2	11899.20
-40020A			

18Pc 1" Dr. Safety Socket Set - Metric

- 1" square explosion-proof sliding T-handle: 3/4"
- 1" square explosion-proof socket extension bar: 200mm
- 1" square explosion-proof section: 120mm
- 15-piece 1" square explosion-proof sockets: 30, 31, 32, 34, 36, 38, 41, 46, 50, 55, 60, 65, 70, 75, 80 (mm)
- Die forging



Aluminum Bronze

Order Code	Weight (kg)	Price RM
TMSF88		
-50018A	24.9	17071.70

15Pc Safety Combination Tool Set - Metric

- Explosion-proof adjustable wrench: 250mm
- Explosion-proof wire cutters: 200mm
- Explosion-proof long nose pliers: 200mm
- Explosion-proof slotted screwdriver: 200mm
- Explosion-proof Phillips screwdriver: 200mm
- Explosion-proof ball pein hammer: 0.91kg, 350mm L
- 9-piece Explosion-proof double open-ended wrench: 8 x 10, 10 x 12, 12 x 14, 14 x 17, 17 x 19, 19 x 22, 22 x 24, 24 x 27, 30 x 32(mm)



Aluminum Bronze

Order Code	Weight (kg)	Price RM
TMSF88		
-01015A	6.2	3750.60

17Pc Safety Combination Tool Set - Metric

- Aluminum bronze
- 2-piece Explosion-proof adjustable wrenches: 200, 300 (mm)
- 6-piece Explosion-proof combination wrenches: 14, 17, 19, 22, 24, 27 (mm)
- Explosion-proof flat shovel: Φ18 x 160mm
- Explosion-proof pointed-tip chisel: Φ18 x 160mm
- Explosion-proof Slotted screwdriver: 6 x 150mm
- Explosion-proof Phillips screwdriver: No.2 x 150mm
- Explosion-proof handle ball pein hammer: 0.91kg
- Explosion-proof pipe wrench: 350mm
- Explosion-proof wire cutters: 200mm
- Explosion-proof long nose pliers: 200mm
- Explosion-proof slip joint waterpump pliers: 200mm



Aluminum Bronze

Order Code	Weight (kg)	Price RM
TMSF88		
-02017A	8.6	6016.50

28Pc Safety Combination Tool Set - Metric

- Aluminum bronze
- 2-piece Explosion-proof plumbing pliers: 300, 450 (mm)
- 2-piece Explosion-proof adjustable wrench: 200, 300 (mm)
- 11-piece Explosion-proof combination wrenches: 8, 10, 12, 14, 17, 19, 22, 24, 27, 30, 32 (mm)
- Explosion-proof F clamp: 400mm
- Explosion-proof wire cutters: 200mm
- Explosion-proof long nose pliers: 200mm
- Explosion-proof slip joint waterpump pliers: 200mm
- Explosion-proof crowbar: Φ25x300mm
- Explosion-proof flat shovel: Φ25x300mm
- Explosion-proof Slotted screwdriver: 100, 200 (mm)
- Explosion-proof Phillips screwdriver: No.2 x 100, No.3 x 200 (mm)
- Explosion-proof handle sledge hammer: 1.8kg / 370mm
- Explosion-proof handle ball pein hammer: 0.91kg / 350mm
- Explosion-proof handle claw hammer: 0.45kg / 300mm

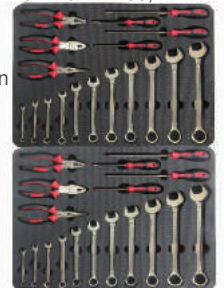

Aluminum Bronze

Order Code	Weight (kg)	Price RM
TMSF88		
-03028A	18.4	10960.90

126Pc Electrician's Safety Tool Kit - Al-Br

- Size of the included tool:
 - 5 x Explosion-proof 1/2" square sockets (8mm/10mm/12mm/14mm/17mm)
 - 5 x Explosion-proof combination wrenches (8mm/10mm/12mm/14mm/17mm)
 - 5 x Explosion-proof L-wrenches (4mm/5mm/6mm/8mm/10mm)
 - 1 x Explosion-proof 1/2" square sliding head handle (250mm)
 - 1 x Explosion-proof round flat shovel (18"180mm)
 - 1 x Explosion-proof adjustable wrench (150mm)
 - 1 x Explosion-proof combination pliers (200mm)
 - 1 x Explosion-proof slip joint waterpump pliers (200mm)
 - 1 x Explosion-proof long nose pliers (150mm)
 - 2 x Explosion-proof Phillips screwdriver (No.2 x 150mm & No.3 x 200mm)
 - 2 x explosion-proof Slotted screwdriver (150mm & 200mm)
 - 1 x Explosion-proof machinist hammer (150g)



Aluminum Bronze

Order Code	Weight (kg)	Price RM
TMSF88		
-20026A	4.5	5250.30

15Pc Safety Jobber Drill Set - Be-Cu

- Includes the size of the drill:
 - 6 x 100mm, 7 x 120mm, 8 x 140mm, 9 x 160mm
 - 10 x 180 mm, 11 x 200 mm, 12 x 220 mm
 - 13 x 240 mm, 14 x 260 mm, 15 x 280 mm
 - 16 x 300mm, 17 x 300mm, 18 x 320mm
 - 19 x 320mm, 20 x 330mm



Aluminum Bronze

Order Code	Weight (kg)	Price RM
TMSF88		
-80015B	3.65	19574.50

Stainless Steel Tools

- High-density material forged, anti-magnetic, anti-acid, anti-alkali, anti-humid
- Beautiful appearance, fine design
- Manufactured to DIN Standard

Double Open Ended Spanners



Order Code	Size (mm)	Length (mm)	Weight (g)	Price RM
TMTT01				
-20507A	5.5 x 7	90	23	27.10
-20607A	6 x 7	92	25	28.50
-20709A	7 x 9	96	28	32.50
-20810A	8 x 10	100	34	35.90
-20911A	9 x 11	110	50	40.10
-21011A	10 x 11	115	52	42.00
-21012A	10 x 12	120	60	44.10
-21014A	10 x 14	124	68	44.50
-21213A	12 x 13	128	73	46.60
-21214A	12 x 14	130	75	48.10
-21415A	14 x 15	143	115	59.60
-21417A	14 x 17	150	120	64.90
-21617A	16 x 17	157	130	69.10
-21618A	16 x 18	163	145	71.40
-21719A	17 x 19	170	150	73.70
-21721A	17 x 21	173	185	81.20
-21819A	18 x 19	179	200	98.40
-21921A	19 x 21	182	210	102.80
-21922A	19 x 22	185	220	106.00
-21924A	19 x 24	190	235	119.00
-22022A	20 x 22	195	250	125.50
-22123A	21 x 23	200	270	133.10
-22126A	21 x 26	205	275	134.10
-22224A	22 x 24	210	312	136.40
-22227A	22 x 27	215	320	159.10
-22326A	23 x 26	220	330	167.70
-22427A	24 x 27	230	345	187.90
-22430A	24 x 30	233	365	222.30
-22528A	25 x 28	236	365	256.40
-22632A	26 x 32	243	465	275.00
-22730A	27 x 30	250	485	285.70
-23032A	30 x 32	265	610	317.20
-23036A	30 x 36	270	815	360.40
-23234A	32 x 34	270	815	363.80
-23236A	32 x 36	300	885	394.40
-23436A	34 x 36	300	885	419.80
-23638A	36 x 38	330	1350	468.70
-23641A	36 x 41	330	1350	498.30
-23840A	38 x 40	330	1350	511.90
-24146A	41 x 46	360	1690	616.90

Stainless Steel Heavy Duty Pipe Wrenches - American Pattern



Order Code	Size (Inch/mm)	Max Opening (mm)	Weight (g)	Feature	Price RM
TMTT50					
-71002A	8"	200	420	Full stainless steel	302.10
-71004A	10"	250	735	Full stainless steel	378.20
-71006A	12"	300	1050	Full stainless steel	513.20
-71008A	14"	350	1315	Full stainless steel	662.70
-71010A	18"	450	2255	Aluminum handle	1018.20
-71012A	24"	600	3465	Aluminum handle	1493.60
-71014A	36"	900	5880	Aluminum handle	2586.30
-71016A	48"	1200	12600	Aluminum handle	3699.40

Combination Spanners



Order Code	Size (mm)	Length (mm)	Weight (g)	Price RM
TMTT02				
-10106A	6	105	18	41.10
-10107A	7	120	40	45.20
-10108A	8	120	40	52.00
-10109A	9	135	45	58.30
-10110A	10	135	45	73.50
-10111A	11	150	65	84.80
-10112A	12	150	65	93.70
-10113A	13	175	90	106.20
-10114A	14	175	90	118.80
-10115A	15	195	140	130.80
-10116A	16	195	140	144.00
-10117A	17	195	140	150.80
-10118A	18	215	180	158.50
-10119A	19	215	180	162.90
-10120A	20	215	180	170.80
-10121A	21	245	280	190.50
-10122A	22	245	280	197.90
-10123A	23	265	320	215.80
-10124A	24	265	320	227.90
-10125A	25	265	500	261.70
-10126A	26	290	500	292.20
-10127A	27	290	500	333.70
-10130A	30	320	700	397.10
-10132A	32	340	780	461.50
-10134A	34	360	1000	536.00
-10136A	36	360	1000	601.70
-10138A	38	430	1450	654.80
-10141A	41	430	1420	796.10
-10146A	46	480	1760	903.60
-10150A	50	520	2020	964.50
-10155A	55	560	2000	1057.90
-10160A	60	595	2920	1143.70
-10165A	65	595	3440	1255.00

Stainless Steel Reversible Ratchet Wrenches



Order Code	Square Drive	Length (mm)	Weight (g)	Price RM
TMTT48				
-71002A	3/8"	200	290	274.50
-71004A	1/2"	245	690	435.10
-71006A	3/4"	320	1570	873.20
-71008A	1"	550	3470	1580.90

Stainless Steel Ball Pein Hammers - Fiberglass Shafts



Order Code	Size	Length (mm)	Weight (g)	Price RM
TMTT55				
-11002A	0.5lb / 8oz / 230g	280	400	81.00
-11004A	0.75lb / 12oz / 340g	280	500	117.20
-11006A	1.0lb / 16oz / 450g	310	680	152.90
-11008A	1.5lbs / 24oz / 680g	340	950	228.30
-11010A	2lbs / 32oz / 910g	350	1200	303.10
-11012A	2.5lbs / 40oz / 1130g	400	1470	371.90

Double Offset Ring Spanners



Order Code	Size (mm)	Length (mm)	Weight (g)	Price RM
TMTT03				
-30507A	5.5 x 7	115	22	28.10
-30607A	6 x 7	115	25	29.20
-30709A	7 x 9	130	50	33.20
-30810A	8 x 10	130	55	37.60
-30911A	9 x 11	140	70	42.70
-31011A	10 x 11	140	80	44.30
-31012A	10 x 12	140	85	46.00
-31213A	12 x 13	160	120	46.60
-31214A	12 x 14	160	151	47.40
-31417A	14 x 17	220	205	75.80
-31618A	16 x 18	220	220	87.70
-31719A	17 x 19	250	225	91.90
-31722A	17 x 22	250	290	105.60
-31819A	18 x 19	250	295	113.60
-31922A	19 x 22	280	310	117.90
-31924A	19 x 24	310	355	132.70
-32123A	21 x 23	285	405	152.00
-32126A	21 x 26	320	450	159.10
-32224A	22 x 24	310	455	164.00
-32427A	24 x 27	340	520	167.70
-32430A	24 x 30	350	550	219.10
-32528A	25 x 28	350	580	242.90
-32632A	26 x 32	370	640	279.80
-32730A	27 x 30	360	705	289.60
-33032A	30 x 32	380	805	338.80
-33036A	30 x 36	395	1050	430.70
-33234A	32 x 34	400	1080	441.40
-33236A	32 x 36	405	1145	472.90
-33436A	34 x 36	420	1165	498.90
-33641A	36 x 41	445	1600	555.00

Stainless Steel Adjustable Wrenches



Order Code	Size (Inch)	Max Opening (mm)	Weight (g)	Price RM	
TMTT05					
-51002A	4"	100	13	33	176.10
-51004A	6"	150	18	135	226.30
-51006A	8"	200	24	281	304.40
-51008A	10"	250	30	440	377.80
-51010A	12"	300	36	720	489.10
-51012A	15"	375	46	1410	752.90
-51014A	18"	450	55	2261	948.10
-51016A	24"	600	65	4705	1679.80

Stainless Steel Claw Hammers - Fiberglass Shafts



Order Code	Size	Length (mm)	Weight (g)	Price RM
TMTT55				
-61002A	0.5lb / 8oz / 230g	280	405	104.90
-61004A	1.0lb / 16oz / 450g	300	652	164.50
-61006A	1.5lbs / 24oz / 680g	330	953	232.80

Stainless Steel Lineman's Pliers



Order Code	Size	Weight (g)	Price RM
TMTT10			
-11002A	6" / 150mm	180	257.10
-11004A	7" / 180mm	355	319.70
-11006A	8" / 200mm	465	347.80
-11008A	10" / 250mm	550	435.10

Stainless Steel Snipe Nose Pliers



Order Code	Size	Weight (g)	Price RM
TMTT11			
-41002A	6" / 150mm	190	270.60
-41004A	8" / 200mm	335	323.20

Stainless Steel Diagonal Cutting Pliers



Order Code	Size	Weight (g)	Price RM
TMTT12			
-31002A	6" / 150mm	245	281.20
-31004A	8" / 200mm	410	315.10

Stainless Steel Grip Wrench



Order Code	Size	Weight (g)	Price RM
TMTT25			
-71002A	9" / 225mm	480	495.20

Stainless Steel Funnels



Order Code	Dia. (mm)	Height (mm)	Weight (g)	Price RM
TMTT70				
-91002A	160	130	260	145.90
-91004A	160	150	280	153.20

Stainless Steel Screwdrivers

Slotted



Order Code	Size	Overall length (mm)	Tip Size (mm)	Weight (g)	Price RM
TMTT30					
-11002A	2" / 50mm	134	3.0	35	41.30
-11004A	2" / 50mm	134	4.5	43	45.40
-11006A	3" / 75mm	159	3.0	35	46.20
-11008A	3" / 75mm	159	4.0	45	52.20
-11010A	3" / 75mm	180	5.0	70	53.70
-11012A	4" / 100mm	184	4.0	45	56.40
-11014A	4" / 100mm	205	5.0	75	59.80
-11016A	4" / 100mm	215	6.0	85	62.90
-11018A	5" / 125mm	240	6.0	100	70.50
-11020A	6" / 150mm	265	6.0	110	80.60
-11022A	6" / 150mm	265	7.0	125	84.40
-11024A	6" / 150mm	277	8.0	140	89.00
-11026A	8" / 200mm	327	8.0	165	99.10
-11028A	10" / 250mm	377	9.0	185	129.90
-11030A	10" / 250mm	377	11.0	260	138.10
-11032A	12" / 300mm	427	10.0	245	157.30
-11034A	12" / 300mm	427	11.0	290	166.90
-11036A	14" / 350mm	477	11.0	320	199.50
-11038A	16" / 400mm	550	12.0	450	227.90

Phillips



Order Code	Size	Overall length (mm)	Blade Dia. (mm)	Weight (g)	Price RM
TMTT31					
-21002A	2" / 50mm	134	3.0	35	42.00
-21004A	3" / 75mm	159	4.0	70	48.90
-21006A	4" / 100mm	205	5.0	75	58.60
-21008A	5" / 125mm	240	6.0	100	72.20
-21010A	6" / 150mm	265	6.0	110	84.20
-21012A	8" / 200mm	327	8.0	165	99.30
-21014A	10" / 250mm	377	8.0	185	135.40
-21016A	12" / 300mm	427	9.0	245	161.20
-21018A	14" / 350mm	477	9.0	270	201.90
-21020A	16" / 400mm	550	9.0	295	232.30
-21022A	18" / 450mm	600	9.0	320	246.90

Stainless Steel Stripping Knives



Order Code	Blade length (mm)	Overall length (mm)	Weight (g)	Price RM
TMTT80				
-11002A	80	190	75	169.60
-11004A	137	250	95	204.70

Stainless Steel Fuel Container



Order Code	Capacity (mm)	Height (mm)	Weight (g)	Price RM
TMTT70				
-01002A	10	300	1680	921.00

Stainless Steel Rotary Pump

- Acid and alkali resistance, anti-corrosion
- Suitable for diesel, kerosene, engine oil, cooking oil, lubricating oil, etc., DO NOT USE with gasoline.
- Optional: Change to copper gears can be used with low ignition temperatures liquids, such as gasoline, benzene, etc.



Welcome to consult

Order Code	Length (mm)	Weight (kg)	Price RM
TMTT71			
-41002A	1350	6	4028.30

Stainless Steel Heel and Point Crowbars



Order Code	Overall length (mm)	Dia. (mm)	Width (mm)	Weight (g)	Price RM
TMTT75					
-31002A	500	15	15	672	235.50
-31004A	500	19	19	1093	386.40
-31006A	500	20	20	1148	403.20
-31008A	500	23	23	1481	520.40
-31010A	600	25	25	2132	739.00
-31012A	800	23	23	2530	870.80
-31014A	1000	30	30	5193	1879.00

Stainless Steel Flat Chisels



Order Code	Overall length (mm)	Dia. (mm)	Width (mm)	Weight (g)	Price RM
TMTT73					
-41002A	160	14	14	175	71.20
-41004A	160	16	16	231	82.50
-41006A	160	18	18	295	110.00
-41008A	200	18	18	382	139.40
-41010A	200	20	20	473	169.60
-41012A	250	24	24	822	290.10
-41014A	300	24	24	1025	361.70
-41016A	300	25	25	1302	459.00
-41018A	400	25	25	1502	526.40
-41020A	500	25	25	1903	662.90
-41022A	500	30	30	2730	934.60

Stainless Steel Buckets



Order Code	Type	Capacity (L)	Height (mm)	Weight (g)	Price RM
TMTT70					
-81002A	Opening	10	250	1200	609.30
-81004A	Opening	15	280	1550	790.10
-71002A	With cover	15	280	2000	1004.70

Slogging Wrenches & Heavy Duty Spanners

- Applicable to petroleum, chemical, metallurgy, electric power, oil refining, shipbuilding, petrochemical, mining machinery and other industries
- Tools required in equipment installation, maintenance & inspection works
- High-quality alloy steel forged, durable
- Sand blasting, non-slip and rust prevention surface
- Strong anti-strike wrenches
- Manufactured to German DIN standard

Open Jaw Slogging Wrenches

- Manufactured to German DIN 133



Metric				
Order Code	Size (mm)	Length (mm)	Weight (g)	Price RM
TMSP50				
-10022A	22	135	190	37.60
-10024A	24	150	230	46.10
-10027A	27	175	390	59.70
-10030A	30	190	500	72.50
-10032A	32	190	540	81.40
-10036A	36	210	700	116.90
-10038A	38	220	820	134.20
-10041A	41	230	900	149.80
-10046A	46	250	1200	206.70
-10050A	50	275	1400	215.70
-10055A	55	305	1800	280.00
-10060A	60	315	2110	343.70
-10065A	65	335	2850	436.60
-10070A	70	370	3550	513.40
-10075A	75	375	4000	608.60
-10080A	80	400	5500	726.20
-10085A	85	400	5200	851.30
-10090A	90	445	7000	1064.10
-10100A	100	485	10500	1378.70
-10110A	110	512	13200	1809.80
-10120A	120	530	17200	2184.10
-10130A	130	560	18500	2632.20
-10140A	140	630	24000	3225.00
-10150A	150	630	23800	3919.10

Imperial				
Order Code	Size (inch)	Length (mm)	Weight (g)	Price RM
TMSP50				
-20010A	7/8"	135	190	45.80
-20020A	15/16"	150	230	55.70
-20030A	1"	175	390	64.00
-20040A	1-1/8"	190	500	83.80
-20050A	1-1/4"	190	540	96.80
-20060A	1-7/16"	210	700	135.40
-20070A	1-1/2"	220	820	152.40
-20080A	1-5/8"	230	900	186.00
-20090A	1-3/4"	250	1200	221.40
-20100A	2"	275	1400	256.40
-20110A	2-1/8"	305	1800	331.80
-20120A	2-3/8"	315	2110	400.90
-20130A	2-1/2"	335	2850	458.50
-20140A	2-3/4"	370	3550	593.00
-20150A	3"	375	4000	681.70
-20160A	3-1/8"	400	5500	809.80
-20170A	3-1/2"	445	7000	1148.90
-20180A	4"	485	10500	1541.90

Angled Ring Slogging Wrenches



Order Code	Size (mm)	Length (mm)	Weight (g)	Price RM
TMSP57				
-10022B	22	140	220	53.00
-10024B	24	160	280	60.00
-10027B	27	175	350	66.70
-10030B	30	190	500	84.80
-10032B	32	190	450	101.30
-10036B	36	210	600	124.90
-10041B	41	225	850	152.10
-10046B	46	240	1100	192.20
-10050B	50	255	1300	219.60
-10055B	55	270	1500	275.30
-10060B	60	285	2000	331.90
-10065B	65	300	2500	394.20
-10070B	70	320	2800	500.40
-10075B	75	330	3200	580.00

Open Jaw Spanners

- Manufactured to German DIN 894



Order Code	Size (mm)	Length (mm)	Weight (g)	Price RM
TMSP30				
-10014A	14	140	90	21.40
-10017A	17	160	100	24.00
-10019A	19	170	120	27.20
-10022A	22	195	160	32.70
-10024A	24	220	180	39.30
-10027A	27	240	270	44.90
-10030A	30	260	300	51.40
-10032A	32	275	380	57.90
-10034A	34	290	470	65.90
-10036A	36	310	500	77.50
-10041A	41	345	580	98.50
-10046A	46	375	900	137.40
-10050A	50	410	1150	172.50
-10055A	55	450	1400	275.50
-10060A	60	490	2000	354.30
-10065A	65	530	2800	444.30
-10070A	70	570	3050	527.90
-10075A	75	610	3500	649.30
-10080A	80	645	4600	707.70
-10085A	85	690	5200	796.60
-10090A	90	850	6100	934.40
-10095A	95	850	6100	1043.90
-10100A	100	1000	7700	1270.80
-10105A	105	1000	7700	1385.90
-10110A	110	1000	9000	1490.60
-10115A	115	1000	9000	1569.40
-10120A	120	1000	9050	1626.60
-10125A	125	1000	9050	1699.40

Open Jaw Slogging Wrenches

- Manufactured to German DIN 7444



Metric				
Order Code	Size (mm)	Length (mm)	Weight (g)	Price RM
TMSP55				
-10017A	17	165	200	32.00
-10019A	19	165	190	34.80
-10022A	22	165	230	40.80
-10024A	24	165	220	44.60
-10027A	27	175	330	58.30
-10030A	30	185	450	67.00
-10032A	32	185	440	79.50
-10036A	36	205	550	95.30
-10041A	41	225	710	122.60
-10046A	46	235	900	148.20
-10050A	50	250	1200	180.20
-10055A	55	265	1360	202.70
-10060A	60	274	1500	253.30
-10065A	65	298	1900	310.40
-10070A	70	320	2300	348.60
-10075A	75	326	2850	432.90
-10080A	80	350	3400	564.20
-10085A	85	355	4100	651.30
-10090A	90	390	5200	833.30
-10100A	100	420	6700	1044.50
-10110A	110	450	8640	1343.30
-10120A	120	480	10400	1658.80
-10130A	130	510	11900	1965.90
-10140A	140	520	12280	2173.30
-10150A	150	565	13650	2580.80
-10160A	160	585	15800	3172.90

Imperial				
Order Code	Size (inch)	Length (mm)	Weight (g)	Price RM
TMSP55				
-20010A	7/8"	165	230	56.90
-20020A	15/16"	165	220	61.90
-20030A	1"	175	330	80.80
-20040A	1-1/8"	185	450	108.10
-20050A	1-1/4"	185	440	114.80
-20060A	1-7/16"	205	550	130.40
-20070A	1-1/2"	225	625	143.50
-20080A	1-5/8"	225	710	165.30
-20090A	1-3/4"	235	900	186.50
-20100A	2"	250	1200	229.90
-20110A	2-1/8"	265	1360	255.60
-20120A	2-3/8"	274	1500	324.40
-20130A	2-1/2"	298	1900	395.70
-20140A	2-3/4"	320	2300	446.60
-20150A	3"	326	2850	559.80
-20160A	3-1/8"	350	3400	701.30
-20170A	3-1/2"	390	5200	986.60
-20180A	4"	420	6700	1238.60

Double Open Ended Spanners

• Manufactured to German DIN 895



Order Code	Size (mm)	Length (mm)	Weight (g)	Price RM
-10120A	14 × 17	160	80	34.10
-10140A	17 × 19	180	110	36.80
-10170A	19 × 22	200	150	42.00
-10180A	19 × 24	220	170	44.60
-10210A	22 × 24	230	230	51.50
-10230A	24 × 27	255	320	65.40
-10260A	27 × 30	280	400	81.10
-10280A	30 × 32	300	500	113.00
-10300A	32 × 36	320	600	127.20
-10305A	34 × 36	330	700	143.80
-10310A	36 × 41	350	850	168.80
-10320A	41 × 46	380	1000	225.90
-10330A	46 × 50	420	1250	283.20
-10340A	50 × 55	460	1800	375.50
-10360A	55 × 60	500	2650	448.60
-10370A	60 × 65	540	2700	536.60
-10380A	65 × 70	580	3450	626.80
-10390A	70 × 75	620	3900	793.50
-10400A	75 × 80	660	4620	902.00

Offset Double Ring Spanners

• Manufactured to German DIN 838



Order Code	Size (mm)	Length (mm)	Weight (g)	Price RM
-10090A	17 × 19	280	170	55.00
-10110A	19 × 22	300	200	58.20
-10120A	19 × 24	320	300	66.70
-10140A	21 × 23	320	350	77.00
-10150A	22 × 24	330	400	84.50
-10185A	24 × 27	340	450	93.60
-10220A	27 × 30	350	500	123.90
-10245A	30 × 32	370	650	146.00
-10270A	32 × 36	430	950	165.90
-10290A	36 × 41	470	1200	224.90
-10300A	41 × 46	500	1500	278.60
-10310A	46 × 50	525	1800	334.50
-10320A	50 × 55	550	2700	406.30
-10330A	55 × 60	575	3000	464.10
-10340A	60 × 65	600	3600	555.30
-10350A	65 × 70	625	3900	669.70
-10360A	70 × 75	650	4300	840.50
-10370A	75 × 80	675	4800	954.00

Heavy Duty Reversible Ratchet Wrenches

- Forging products
- Used for clamping, assembling and disassembling parts such as pipes and shafts. One-hand operation, convenient and quick



Order Code	Square Drive	Overall Length (mm)	Weight (g)	Price RM
-40320A	3/4"	320	1490	662.00
-50550A	1"	550	3220	948.90
-60600A	1-1/2"	600	4600	1246.60

Combination Spanners

• Manufactured to German DIN 3133



Order Code	Size (mm)	Length (mm)	Weight (g)	Price RM
-10022A	22	245	235	45.50
-10024A	24	265	250	47.70
-10027A	27	290	400	75.20
-10030A	30	320	520	96.40
-10032A	32	340	640	116.50
-10036A	36	360	550	150.30
-10041A	41	430	1360	240.90
-10046A	46	480	1810	293.60
-10050A	50	520	2020	366.10
-10055A	55	560	2580	465.90
-10060A	60	595	3100	559.00
-10065A	65	595	3400	612.30
-10070A	70	630	4200	711.00
-10075A	75	630	4000	773.90
-10080A	80	660	5400	851.90
-10085A	85	660	5200	952.50
-10090A	90	720	7100	1050.20
-10095A	95	720	6800	1162.00
-10100A	100	780	8400	1300.10
-10105A	105	780	8100	1637.20
-10110A	110	840	9800	1767.20
-10115A	115	840	9500	1960.50
-10120A	120	900	12100	2160.90
-10125A	125	900	11800	2305.80

Offset Ring Spanners with Extension Bars



Order Code	Size (mm)	Length (mm)	Weight (g)	Price RM
-20024A	24	180	450	88.50
-20027A	27	190	500	100.50
-20030A	30	200	550	116.40
-20032A	32	235	750	164.50
-20036A	36	245	850	186.70
-20041A	41	265	1000	224.30
-20046A	46	280	1400	304.10
-20050A	50	290	1600	341.60
-20055A	55	300	1750	403.70
-20060A	60	345	2800	533.70
-20065A	65	355	3200	602.00
-20070A	70	365	3700	679.40
-20075A	75	375	4100	737.30
-20080A	80	385	4900	888.00

Hook Spanners

• Manufactured DIN 1810



C-Hook Spanners

Order Code	Size (mm)	Length (mm)	Weight (g)	Price RM
-00032C	30 - 32	140	60	19.30
-00036C	34 - 36	170	90	23.70
-00042C	40 - 42	176	100	30.90
-00050C	45 - 50	209	150	34.60
-00055C	52 - 55	212	160	37.00
-00062C	58 - 62	244	210	40.40
-00075C	68 - 75	250	250	47.60
-00090C	80 - 90	284	370	70.00
-00100C	95 - 100	288	410	77.10
-00115C	110 - 115	337	700	130.60
-00130C	120 - 130	343	750	139.00
-00145C	135 - 145	388	1050	193.10

Adjustable C-Hook Spanners

-10050C	19 - 50	162	110	54.40
-10075C	32 - 75	205	225	65.60
-10120C	50 - 120	288	450	162.10
-10170C	115 - 170	310	580	206.00

Pin Type Hook Spanners



Pin Type Hook Spanners

Order Code	Size (mm)	Length (mm)	Weight (g)	Price RM
-20014C	12 - 14	116	12	26.50
-20018C	16 - 18	116	15	28.80
-20022C	20 - 22	125	22	30.80
-20028C	25 - 28	139	32	37.30
-20032C	30 - 32	136	50	42.50
-20036C	34 - 36	171	90	45.80
-20042C	40 - 42	171	100	54.70
-20050C	45 - 50	207	150	65.60
-20055C	52 - 55	207	160	80.10
-20062C	58 - 62	243	230	99.00
-20075C	68 - 75	243	250	113.10
-20090C	80 - 90	281	370	125.60
-20100C	95 - 100	281	410	147.00
-20115C	110 - 115	333	700	162.80

Adjustable Pin Type Hook Spanners

-30035C	20 - 35 / 2.5	150	90	88.20
-30036C	22 - 35 / 3.0	150	90	93.70
-30060C	35 - 60 / 4.0	170	120	116.60
-30061C	35 - 60 / 5.0	170	120	123.00
-30090C	60 - 90 / 5.0	250	340	145.40
-30091C	60 - 90 / 5.5	250	340	156.60

Mod G Professional Nodular Cast Iron G Clamps

- Nodular cast iron G clamps, anti-oxidation paint coating, anti-corrosion rust
- T-handle for greater clamping force
- Widely applicable to various standard, medium, heavy and super heavy industrial fields
- Made in Spain



Order Code	Type	Opening (cm)	Throat (cm)	Weight (kg)	Max pressure (N)	Price RM
PHCL60						
-20005G	Standard type	5	4.5	0.20	3500	121.20
-20008G	medium type	8	7.0	0.70	8000	187.40
-20010G	heavy type	10	8.5	1.00	11000	282.10
-20015G	super heavy type	15	12.5	2.50	20000	482.70

Mod GF. Professional Super Heavy Duty Nodular Cast Iron G Clamps

- Nodular cast iron G clips, anti-oxidation paint coating, anti-corrosion rust
- Precision thread plus T-shaped handle for maximum clamping force
- Suitable for all kinds of extremely heavy industrial fields
- Made in Spain



Order Code	Opening (cm)	Throat (cm)	Weight (kg)	Max pressure (N)	Price RM
PHCL61					
-21010G	10	5.5	2.50	40000	703.10
-21015G	15	7.5	4.00	40000	969.80
-21020G	20	11.0	9.00	40000	1556.10

Industrial American Pattern Heavy Duty G Clamps

- Made of high quality ductile iron material, durable
- Manufactured from one piece die casting process
- Clamp force weighting design, increasing the contact surface and fastening force, strong clamping effect
- The body is polished and painted, beautiful & rust prevention
- Carbon steel rod is heat treated, high hardness and large torque



Order Code	Size	Clamping Range(mm)	Throat Depth(mm)	Weight (g)	Price RM
TMCL50					
-10020A	2"	56	22	213	13.30
-10030A	3"	82	40	427	23.30
-10040A	4"	105	45	652	31.50
-10050A	5"	130	56	874	38.10
-10060A	6"	158	60	1118	50.50
-10080A	8"	209	67	1580	64.70
-10100A	10"	253	81	1895	78.80
-10120A	12"	296	87	2782	108.70

Industrial Heavy Duty T - Handle Clamps

- High-quality alloy steel forging, thicken and special process heat treatment body, durable
- High quality sliding bar, smooth surface, easy to use, safe and reliable
- Alloy steel pads, the surface is smooth which can effectively prevent object damage
- Alloy steel black oxidized T-spindle, strengthen structure, anti-rust, anti-bending & anti-twist
- Non-slip buckle design



Order Code	Clamping Range(mm)	Throat Depth(mm)	Price RM
TMCL15			
-00160A	160	80	55.50
-00200A	200	120	123.40
-00250A	250	120	130.40
-00300A	300	140	133.50
-00400A	400	120	144.30
-00500A	500	120	171.90
-00600A	600	120	176.80

Triangle Shaped Magnetic Welding Clamps

- These strong and compact magnets provide a fast and easy way to hold two pieces of steel together
- Powerful magnet encased in durable steel
- The arrow shape magnet permits panels to be arranged at 45, 90 or 135 degree angles.
- Excellent for holding pipe and metal in up right positions
- The magnets can be conveniently moved with the centre hole, and are easy to remove for cleaning
- The strong clamping force makes these magnets ideal for flat pieces, round and square tubing.



Order Code	Size L x W x T (mm)	Capacity (kg)	Weight (g)	Price RM
TMCL55				
-01025A	120 x 84 x 14	12	330	35.30
-01050A	156 x 103 x 17	22	630	43.40
-01075A	190 x 122 x 25	33	1080	57.60
-01100A	212 x 142 x 25	44	1080	82.30

Super Powerful Magnetic Pick-Up Wands

- Super Powerful Magnetic Pick-up Wands are innovative and powerful tools to remove ferrous materials in wet or dry environments.
- Constructed with neodymium/rare earth magnets to maximize holding power.
- Pull to release collected material to dispose of.
- Ideal for removing hardware from storage bins.
- Unique shape allows for easy pick up from walls and corners.
- Non-corrosive, stainless steel housing
- Strong magnet that attracts large amounts of swarf and metal shavings
- Comfortable hand grip for better control



Order Code	Size L x D (mm)	Capacity (kg)	Weight (g)	Price RM
TMOT10				
-50350A	350 x ø25	8	552	249.60

Powerful Eyelet Button Magnets

- Powerful button magnet is great for magnet fishing, lifting, hanging, retrieving applications
- Widely used in construction, mining, oil and gas and metal industries.
- Extremely powerful magnetic pulling force for a direct touch and direct pull under ideal conditions
- Shiny and rust resistant coated steel surface provides protection for the magnet and helps to prevent chipping or cracking.



Order Code	Dimensions od x THICK (mm)	Capacity (kg)	Weight (kg)	Price RM
TMOT10				
-20055A	ø55 x 40	30	0.8	247.10
-20075A	ø75 x 50	60	1.9	471.70
-20090A	ø90 x 60	100	3.3	816.90
-20110A	ø110 x 70	200	5.7	1,276.80
-20130A	ø130 x 100	300	9.0	2,630.70
-20160A	ø150 x 100	400	24.0	4,930.60

Heavy Duty Mechanical Gear Pullers

- Manufactured from heavy duty drop forged chrome vanadium steel.
- Inner and outer combination pulling jaws design.



2 Jaws

3 Jaws

Size	Spread (mm)	2 Jaws		3 Jaws	
		Order Code TMOT20	Price RM	Order Code TMOT20	Price RM
3"	15 - 80	-80003A	66.70	-70003A	83.10
4"	20 - 110	-80004A	85.10	-70004A	106.40
6"	25 - 160	-80006A	167.20	-70006A	215.20
8"	30 - 210	-80008A	329.80	-70008A	412.40
12"	50 - 310	-80012A	811.30	-70012A	988.60



TEMO®

Others

www.temomalaysia.com

TEMO® Chemical Storage Cabinets

EXCELLENT

- Two-layer anti-fire steel plate with 38mm between two steel plates for insulation.
- Main body material: 1.2mm steel plate painted with epoxy resin.
- Safety: Three-linkage lock. The door has two keys and is available to use padlock which realize safe management of double-locked with two key holders.
- Anti-leakage liquid tank with height of 50mm ensures no liquid overflow.
- Specific warning labels for different kinds of safety storage cabinet.
- Adjustable anti-leakage shelves.
- Generally there are three colors of common used materials storage safety cabinet to store various hazardous materials.
- The colour is for distinguishing different type materials in storage and convenient using. The common effect of the each type safety cabinet is for fire prevention, heat insulation and secure storage.
- Equipped with anti-static grounding to prevent static sparks from causing fire.
- Comply with FM Approval Standard(Flammable and Combustible Liquids) OSHA 29 CER 1910.106 of American Occupational Safety and Health Administration, NFPA CODE30 of American National Fire Protection Association etc.

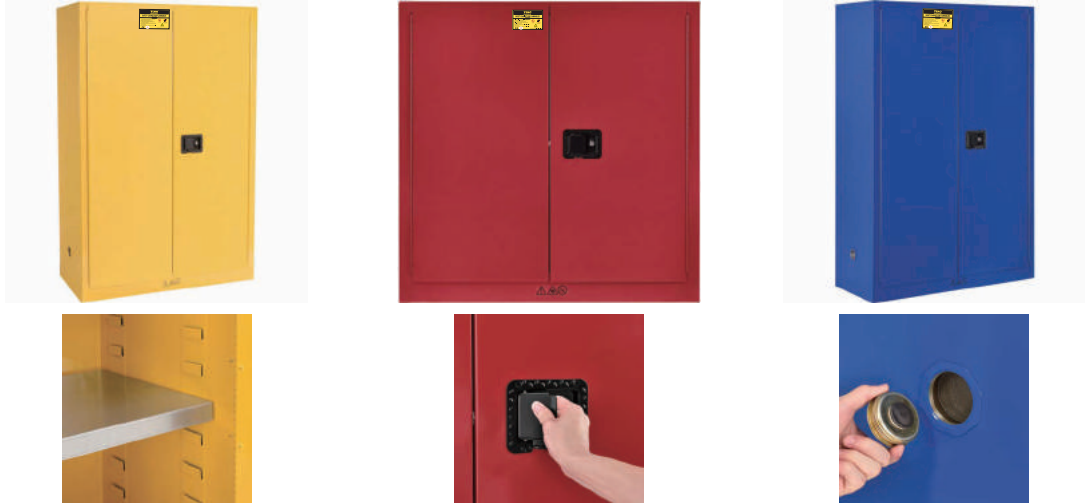

Yellow safety cabinet for storing all kinds of flammable materials, with flashing point below 45°C.

Such as gasoline, alcohol, kerosene, methanol, ethanol, etc, reduce the risk of fire, to ensure the safety of life and property.

Red safety cabinet for storing various kinds of flammable materials, with flashing point below 45°C.

Such as diesel, engine oil lubricating oil, tung oil, etc. Suitable for coating, printing, furniture, automobile and other industries.

Blue safety cabinet for storing various kinds of flammable materials, with flashing point below 45°C.

Such as acetic acid, carbonic acid, phosphoric acid, silicic acid, etc. Suitable for school, research institutes.

YELLOW

RED

BLUE

Order Code TMCH70	Price RM	Order Code TMCH70	Price RM	Order Code TMCH70	Price RM	External Dia (mm)	Internal Dia (mm)	Adjustable shelve plate (Included)	Doors	Capacity (Gal)	Weight (kg)
-01004Y	3306.10	-01004R	3306.10	-01004B	3306.10	560 x 430 x 430	460 x 350 x 350	1	Single	4	25
-01012Y	4408.20	-01012R	4408.20	-01012B	4408.20	890 x 590 x 460	790 x 510 x 380	1	Single	12	40
-01022Y	5510.20	-01022R	5510.20	-01022B	5510.20	1650 x 600 x 460	1550 x 520 x 380	3	Single	22	75
-01030Y	5730.60	-01030R	5730.60	-01030B	5730.60	1120 x 1090 x 460	1020 x 1010 x 380	1	Double	30	80
-01045Y	7273.50	-01045R	7273.50	-01045B	7273.50	1650 x 1090 x 460	1550 x 1010 x 380	2	Double	45	108
-01060Y	8375.50	-01060R	8375.50	-01060B	8375.50	1650 x 860 x 860	1550 x 780 x 780	2	Double	60	130
-01090Y	9477.60	-01090R	9477.60	-01090B	9477.60	1650 x 1090 x 860	1550 x 1010 x 780	2	Double	90	150

Galvanised Steel Shelves Plate: (Optional)

Order Code TMCH70	Size (mm) L x W x H	Suitable for (Gal)	Price RM
-01604P	333 x 330 x 25	4	132.20
-01612P	493 x 360 x 25	12	132.20
-01622P	503 x 360 x 25	22	132.20
-01635P	1008 x 360 x 25	30 / 45	264.50
-01660P	778 x 760 x 25	60	264.50
-01690P	1008 x 760 x 25	90	396.70



TEMO[®] **EXCELLENT** Drum Storage Cabinets

- Two-layer anti-fire steel plate with 38mm between two steel plates for insulation.
- Main body material: 1.2mm steel plate painted with epoxy resin.
- Safety: Three-linkage lock. The door has two keys and is available to use padlock which realize safe management of double-locked with two key holders.
- Anti-leakage liquid tank with height of 50mm ensures no liquid overflow.
- Specific warning labels for different kinds of safety storage cabinet.
- Adjustable anti-leakage shelves.
- Generally there are three colors of common used materials storage safety cabinet to store various hazardous materials.
- The colour is for distinguishing different type materials in storage and convenient using. The common effect of the each type safety cabinet is for fire prevention, heat insulation and secure storage.
- Equipped with anti-static grounding to prevent static sparks from causing fire.
- Comply with FM Approval Standard(Flammable and Combustible Liquids) OSHA 29 CER 1910.106 of American Occupational Safety and Healthy Administration, NFPA CODE30 of American National Fire Protection Association etc.



PP Anti-Corrosive Cabinets

- PP Anti-Corrosive Cabinets has the characteristic of resistance to strong acid,alkali and anti-corrosion. It is applicable to various kinds of laboratories with high requirement for cleanliness,for example: pharmaceutical laboratory,food laboratory,semiconductor laboratory,trace metal laboratory, biology laboratory,etc.
- Cabinet with one piece, seamless welding technology, which greatly strengthened the structure of the cabinet.
- It is used to store strong corrosive chemical products (for example:sulfuric acid,muriatic acid,KOH and NaOH,etc chemical material)
- The structure strong & compact, effectively reduce the risk of deformation.
- Shelf Board: made of 8mm white PP board, can be removed accordingly.
- Two padlocks design,which provide a higher lever security.
- Porcelain white PP board, fresh and pleasant, elegant appearance.
- Comply with CE standard

Single Door



Double Door



Order Code	Drums	External Dia (mm) H x W x D	Internal Dia (mm) H x W x D	Adjustable shelve plate (Included)	Doors	Weight (kg)	Price RM
-02001Y	Single	1650 x 860 x 860	1550 x 780 x 780	1	Double	130	10469.40
-02002Y	Double	1650 x 1500 x 860	1550 x 1420 x 780	1	Double	190	15979.60

Order Code	Model	External Dia (mm) H x W x D	Internal Dia (mm) H x W x D	Capacity (Gal)	Adjustable shelve plate (Included)	Weight (kg)	Price RM
-05041A	Single Door	560 x 430 x 430	40 x 404 x 394	4	1	13	2043.20
-05121A	Single Door	890 x 590 x 460	40 x 564 x 424	12	1	32	3178.30
-05302A	Double Door	1120 x 1090 x 460	50 x 1064 x 424	30	1	38	4540.40
-05452A	Double Door	1650 x 1090 x 460	50 x 1064 x 424	45	2	55	6129.60

Comb. Moving Skates

- These skates are designed for transporting industrial machinery and other heavy equipment.
- Nylon and Steel wheels are strong and will not mark floors.
- Swivel top plate and a pulling bar to allow for easy maneuvering around turns and corners.
- Steel construction with handle to carry and position.
- Skates have a rubber pad, and easily help guide the machinery over firm and level surfaces.



Model TL 3



Model TL6



Model TF 3

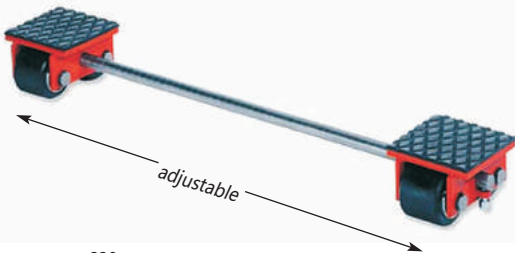

Model TF6

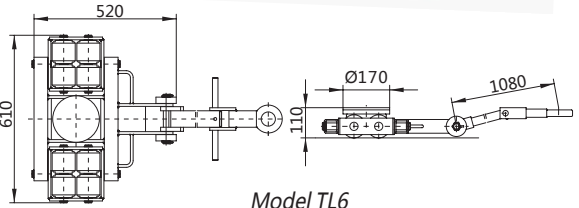
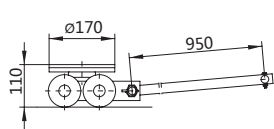
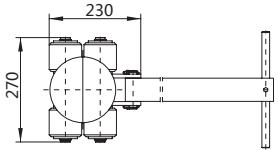
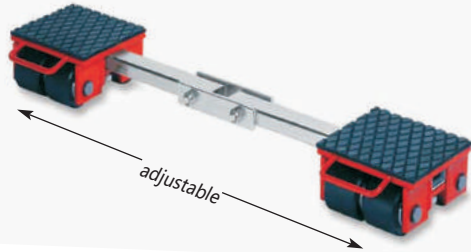

Model TL 3

Model TL6

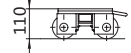
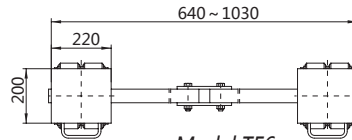
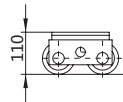
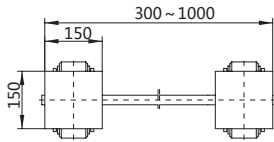

Model TF 3

Model TF6

Order Code	TMLG03-05006C		TMLG03-05012C	
Rear/ Front Skates model	TF3	TL3	TF6	TL6
Load Capacity(t)	3	3	6	6
Comb. Load capacity (t)	6	6	12	12
Working height (mm)	110	110	110	110
Supporting Surface (mm)	150 x 150	Ø170	200 x 200	Ø170
Connecting adjustable length(mm)	300 - 1000	/	640 - 1030	/
Length of adjustable handle (mm)	/	950	/	1080
Operating Handle angle	/	±90°	/	±90°
Roller Dimensions (mm)	Ø85	Ø85	Ø85	Ø85
No. Of Roller	4	4	8	8
Overall Dimensions (mm)	/	270 x 230	/	610 x 520
Net Weight (kg)	15	12	30	41

Price (RM)

2487.90

4527.70

Rotating Moving Skates

- Rotating Roller Machine Skate allows heavy machinery to move easily in and out of tight spaces due to its 360 degree maneuverability.
- It is recommended to be used with multiple dollies for additional stability and flexibility.
- 1090mm operating handle are optional



TCRP-3



TCRP-5

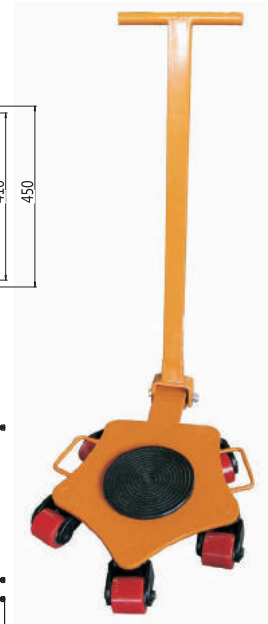
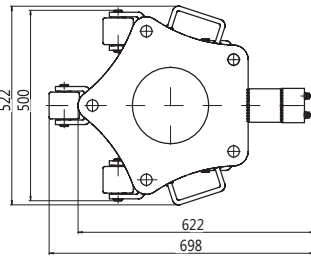
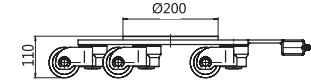
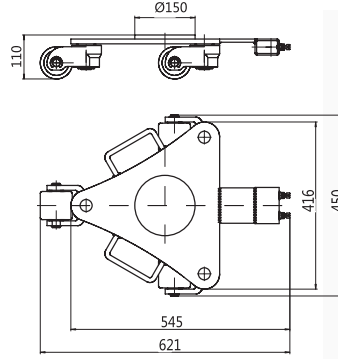

Order Code	TMLG03-05102R	TMLG03-05104R
Model	TCRP-3	TCRP-5
Load Capacity(t)	2	4
Working height (mm)	110	110
Supporting Surface (mm)	Ø150	Ø200
Roller Dimensions (mm)	Ø80 x 70	Ø80 x 70
No. Of Roller	3	5
Overall Dimensions (mm)	621 x 450 x 110	698 x 522 x 110
Net Weight (kg)	21	35
Price (RM)	1714.80	2309.90

Optional operating handle

Order Code	Overall Length (mm)	Price RM
TMLG03-05001P	1090	281.60

Machine Skates

- Machine skates are designed for transporting industrial machinery and other heavy equipment.
- 1060mm operating handle are optional



TCRA

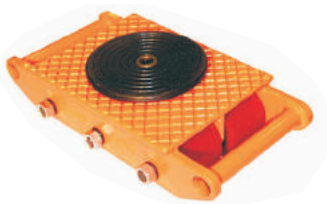

TCRO

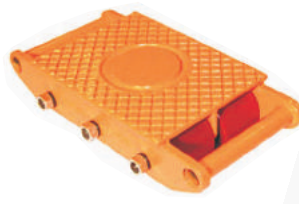

TCRA

Order Code	TMLG03-05206A	TMLG03-05208A	TMLG03-05212A	TMLG03-05218A
Model	TCRA-4	TCRA-6	TCRA-8	TCRA-12
Load Capacity(t)	6	8	12	18
Overall Dimensions (mm)	304 x 222 x 110	404 x 222 x 110	504 x 222 x 110	498 x 305 x 110
Net Weight (kg)	14.5	21.5	27.5	43.5
Price (RM)	904.80	1183.60	1513.10	2096.10

TCRO

Order Code	TMLG03-05206B	TMLG03-05208B	TMLG03-05212B	TMLG03-05218B
Model	TCRO-4	TCRO-6	TCRO-8	TCRO-12
Load Capacity(t)	6	8	12	18
Overall Dimensions (mm)	304 x 222 x 95	404 x 222 x 95	504 x 222 x 95	498 x 305 x 100
Net Weight (kg)	13.0	20.0	26.0	40.0
Price (RM)	866.80	1145.60	1475.10	2058.10

Optional operating handle

Order Code	Overall Length (mm)	Price RM
TMLG03-05002P	1060	281.60



Foldable Silent Trolleys

- Foldable handle
- Silent type nylon castors
- Flat board made of high-strength PT plastic



Order Code	Specification L x W x H(mm)	Flat Board Height(mm)	Capacity (kg)	Weight (kg)	Price RM
-01150A	730 x 490 x 890	170	150	11.5	648.00
-01250A	825 x 500 x 890	215	250	12.0	937.30
-01350A	910 x 600 x 890	220	300	17.0	1006.70

Utility Carts



Order Code	Specification L x W x H(mm)	Capacity (kg)	Shelf Board	Side Opening	Castors	Price RM
-10008A	900 x 550 x 900	300	Without	Without	Rubber Castors	2367.50
-10009A	900 x 550 x 900	300	1	1	Rubber Castors	2673.00

Double Deck Silent Trolleys

- PP material thicken trolley board, environmental friendly, non-slip, corrosion resistance
- Handrail surface is treated with seamless technology
- Natural rubber castors, durable, precision bearings more quiet



Order Code	Specification L x W x H(mm)	Lower Deck Height (mm)	Upper Deck Height (mm)	Interval Between Upper & Lower Deck(mm)	Castor Diameter (mm)	Capacity (kg)	Weight (kg)	Price RM
-02150A	720 x 490 x 880	170	680	475	100	150	11.9	775.80
-02200A	825 x 500 x 890	176	695	465	100	200	17.1	1081.30
-02250A	825 x 500 x 915	210	720	455	125	250	18.4	1340.70
-02300A	900 x 600 x 915	215	720	465	125	300	21.9	1423.20

All in 1 Plastic Storage Bins

- Industrial quality
- Stackable,Supportable,Parallel-connectable,Can fit to louvre panel

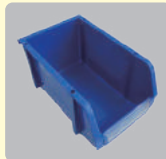

Bin Size	Dimensions (mm)			Blue		Green		Red		Yellow	
	L	x	W x H	Order Code	Price RM	Order Code	Price RM	Order Code	Price RM	Order Code	Price RM
T10	133		85 x 53	01010B	6.00	02010G	6.00	03010R	6.00	04010Y	6.00
T20	163		104 x 80	01020B	11.40	02020G	11.40	03020R	11.40	04020Y	11.40
T30	237		150 x 132	01030B	24.40	02030G	24.40	03030R	24.40	04030Y	24.40
T40	278		222 x 165	01040B	40.00	02040G	40.00	03040R	40.00	04040Y	40.00
T50	350		280 x 184	01050B	73.40	02050G	73.40	03050R	73.40	04050Y	73.40

Spill Pallets / Platforms

- Made of linear low-density polyethylene material, professionally used for leak-proof storage of chemical raw material barrels
- New heightening design, greater storage for leakage
- Product Features:

Adopting seamless structure design, the leakage prevention structure is 100% tested to effectively avoid leakage.

Good acid and alkali corrosion resistance, to prevent possible damage from chemical leakage, can be used outdoors

When leaking out, all the liquid will be automatically injected into the tray leakage area along the tray and will not pollute the scene environment

Can be used with forklift for easier handling

The liquid guiding port is designed to facilitate centralized cleaning of leaking liquid

- Note: Please clean the liquid in the tray in time to avoid overflow. If the leaked area appears to spread, professionals are required to use the corresponding chemical adsorption products for plugging and absorption.**



Platform Ramp

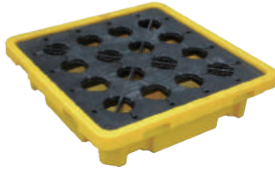

Single Drum Spill Platform

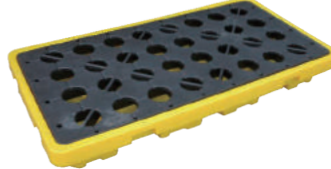

2 Drum Spill Platform

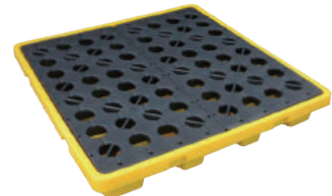

4 Drum Spill Platform



2 Drum Spill Pallet



4 Drum Spill Pallet

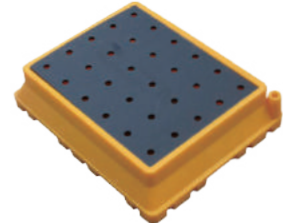

Spill Tray

Order Code	Description	Dimensions (mm)	Size (L)	Capacity (kg)	Weight (kg)	For Forklift	Price RM
TMLG29							
-01043A	Single Drum Spill Platform	670 x 670 x 150	43	700	8	-	897.60
-02080A	2 Drum Spill Platform	1300 x 660 x 150	80	1400	15.5	Forklift	1531.80
-04150A	4 Drum Spill Platform	1300 x 1300 x 150	150	3000	19.5	Forklift	2216.50
-02120B	2 Drum Spill Pallet	1300 x 660 x 300	120	1400	30.5	Forklift/ Pallet Truck	1772.10
-04260B	4 Drum Spill Pallet	1300 x 1300 x 300	260	1400	34.5	Forklift/ Pallet Truck	2584.10
-00011C	Spill Tray	530 x 430 x 110	11	100	3.6	-	897.60
-09150R	Platform Ramp	1200 x 800 x 150	-	-	20	-	3453.80
-09300R	Platform Ramp	1200 x 800 x 300	-	-	22	-	3453.80

4 Way Entry Plastic Pallets

- Made of HDPE, non-toxic, tasteless and odorless
- Stackable, saves space

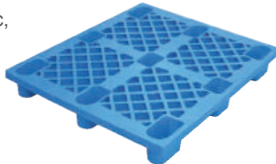

Order Code	Dimensions (mm)	Dynamic load capacity (T)	Static load capacity (T)	Weight (kg)	Price RM
TMLG30					
-01080A	1000 x 800 x 140	0.40	0.90	4.60	204.90
-01109A	1100 x 900 x 140	0.45	0.90	5.80	235.20
-01010A	1000 x 1000 x 140	0.45	0.90	5.00	237.70
-01110A	1100 x 1000 x 140	0.50	1.00	6.60	273.00
-01111A	1100 x 1100 x 140	0.50	1.00	6.50	245.20
-01108A	1100 x 800 x 140	0.45	0.90	5.60	245.20
-01208A	1200 x 800 x 140	0.45	0.90	5.80	230.10
-01210A	1200 x 1000 x 140	0.50	1.00	6.00	285.50
-01211A	1200 x 1100 x 140	0.60	1.20	7.80	300.80
-01212A	1200 x 1200 x 140	0.60	1.20	8.50	307.80
-01311A	1300 x 1200 x 140	0.60	1.20	8.50	324.00

Flat Deck Plastic Pallets

- Made of HDPE, non-toxic, tasteless and odorless
- Anti-slip plate surface, which can better avoid the damage of people or goods caused by the slippage of the goods during transportation.

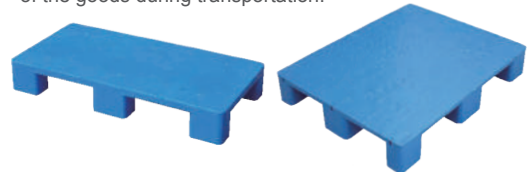

Order Code	Dimensions (mm)	Number of Feet	Dynamic load capacity (T)	Static load capacity (T)	Weight (kg)	Price RM
TMLG30						
-01050B	1000 x 500 x 130	6	0.30	0.60	4.00	222.50
-01060B	1000 x 600 x 130	6	0.40	0.80	5.00	235.20
-01070B	1000 x 700 x 130	6	0.50	1.00	6.00	247.70
-01080B	1000 x 800 x 140	9	1.00	3.00	7.80	300.80
-01190B	1100 x 900 x 140	9	0.80	3.00	9.80	353.60
-01111B	1100 x 1100 x 140	9	1.50	4.00	12.50	368.90
-01210B	1200 x 1000 x 140	9	1.50	4.00	10.50	390.10

IBC 1000L Spill Containment

- Used in the industries of agriculture, farm, residential building or household for storage water or other chemical liquid.
- Frame and pallet are made of steel tubes and adopt heat treatment as well as hotdip galvanizing technology
- Whole frames has the advantages of light weight,good flexibility,large capacity and standing the impact of external forces of the accident.
- Overall dimension:1200*1000*1150mm(±5mm)
- Max Allowable Weight:2012 kg
- Tare Weight:57±2kg
- Allowable Stacking Weight:4184kg
- Material of inner Receptacle: HDPE
- Material of outer Casing :Galvanized steel DCD51D
- Material of pallet: Galvanized steel DC53D
- Material of seal :EPDM,FKM,Nitrile,PE
- Valve and Material:Ball Valve DN50.
- Stacking Test Weight;4184kg
- Dropping Test Height:1.9mm
- Hydraulic Test pressure:100kpa
- Vibration Test:Amplitude:25±5%mm,Time Duration:1 hour
- Certificates : SGS, IQNet.



Order Code	Capacity (L)	Colour	Price RM
TMLG29			
-71000A	1000	White	2005.70
-71000B			2005.70

Heavy Duty Absorbent Socks & Pillows

- For spills of oil, chemicals or water - in even the toughest industrial plant, cleanest lab or clinical environment . we have the right Absorbent Socks for robust and reliable spill containment.
- Perfect for any kind of spill situation involving any liquid, no matter how aggressive, our spill socks are built to trap and hold fluids effectively.
- Each absorbent sock will absorb more than 16 times its own weight.
- Ideal for larger spills when used in conjunction with absorbent socks and pads.

Order Code	Type	Size (mm)	Absorption (kg)	Colour	Quantity	Price RM
TMPA03						
-07612W	Absorbent Socks	ø76 x 1200	5.25	White	20/Box	630.40
-01230W	Absorbent Socks	ø127 x 3000	30.00	White	10/Box	727.40
-02025P	Pillows	200 x 250	2.70	White	32/ Box	664.80

Spill Control Sets

- Mainly used for quick and effective emergency products for oil chemical spill emergency and post-leakage cleaning.
- This cart can also be used as a hardware tool storage truck, which is very convenient to use.
- Particularly suitable for use in marine oil spill emergency assistance, port terminals, shipping vessels, environmental cleaning companies, laboratories, schools, water and electricity departments, municipal water treatment plants, public transportation, auto repair, hospitals and other medical institutions, environmental protection bureaus, etc.
- Emergency kits contains a certain number of adsorption pads, which can absorb the chemicals that wipe the leaks.
- Supporting chemical leakage absorption curing agent and absorbent cotton pillow and Personal protective equipment.



Order Code	Contains	Specification	Quantity	Absorption	Price RM
TMPA50					
-01120K	Wheel Cart	120L	1	-	
	Absorbent Pads	400 x 500 x 2mm	50	30kg	
	Absorbent Socks	76 x 1200mm	10	52.5kg	
	Pillows	200 x 250mm	10	75kg	1434.90
	Hazardous bags	750 x 490mm	8	-	
	protective glasses	-	2	-	
	Chemical Glove	-	2	-	
-02030K	Cable Tie	-	10	-	
	Clear Zip Bag	30L	1	-	
	Absorbent Pads	400 x 500 x 2mm	12	7kg	
	Absorbent Socks	76 x 1200mm	2	10.5kg	
	Pillows	200 x 250mm	2	15kg	291.60
	Hazardous bags	750 x 490mm	2	-	
	protective glasses	-	1	-	
Chemical Glove	-	1	-		
Cable Tie	-	10	-		



Absorbent Socks



Pillows

Industrial Powerful Roll

Product Features:

- Highly efficient water absorption and oil absorption, fast absorption
- Excellent wet strength, not easy tear, not leave dust & hair after wiping

Applications:

- Cleaning of parts and tools
- Wipe and maintenance of mechanical equipments
- Clean belts and rollers
- Clean and wipe sticky oily dirt
- Clean wipe of liquid leakage of hydraulic devices
- **MOQ: 1 box**



Order Code	Size/sheet (mm)	No. of sheets/roll (box)	No. of layers	Surface texture	Colour	Package style	Pack qty	Price RM
TMPA01	245 x 350	550	3	Embossing	White	Roll pack	2 rolls/ctn	277.80
-03680R								

High Oil Absorption Cloth

Product Features:

- Made of special materials that can be naturally degraded and can be reused after cleaning
- Soft to feel, reusable after cleaning
- Highly efficient water absorption and oil absorption
- Super tear resistance and abrasion resistance
- It is not easy to leave hair dust after wiping

Applications:

- Wipe and maintenance of mechanical equipments
- Workplace maintenance and cleaning
- Clean belts and rollers
- Wipe more oily workplace
- Clean wipe of liquid leakage of hydraulic devices
- For user own wipe
- **MOQ: 1 box**



Order Code	Size/sheet (mm)	No. of sheets/roll (box)	No. of layers	Surface texture	Colour	Package style	Pack qty	Price RM
TMPA02	250 x 300	650	Single layer	Plain	White	Roll pack	2 rolls/ctn	594.00
-04600R								

Roll Dispensers

Product Features:

- Easy to take paper/cloth, mobile & flexible
- Smooth and beautiful design
- Easy to clean and maintain the cleanliness of the wiping paper/cloth so that improve simultaneously the wiping and working environment

Applications:

- Workplaces, toilets, hospitals and other places



Order Code	Style	Scope of application: single sheet paper / Width of cloth (mm)	Size (mm)	Pack qty	Price RM
-00100P	Wall-mounted	≤ 330	450 x 265 x 410	1/ctn	231.40
-00200P	Floor-standing	≤ 330	890 x 450 x 300	1/ctn	231.40

Industrial Universal Cloths

Product Features:

- Wood pulp is made of special fibers and can be reused after cleaning
- Highly efficient water absorption and oil absorption
- Super tear resistance and abrasion resistance
- It is not easy to leave hair & dust after wiping

Applications:

- Wipe and maintenance of mechanical equipments
- Workplace maintenance and cleaning
- Clean belts and rollers
- Clean wipe of liquid leakage of hydraulic devices
- For ordinary oil wipe
- For user's own wipe
- **MOQ: 1 box**



Order Code	Size/sheet (mm)	No. of sheets/roll (box)	No. of layers	Surface texture	Colour	Package style	Pack qty	Price RM
-06600R	245 x 350	500	Single layer	Plain	White	Roll pack	2 rolls/ctn	512.00
-06661A	300 x 350	300	Single layer	Embossing	White	Sheet pack	6 boxes/ctn	1041.80

Colorful Industrial Cloths

Product Features:

- Colored wood pulp made of special fiber, more dirt-repellent than white wiping material
- Reusable after cleaning
- Highly efficient water absorption and oil absorption
- Has a certain degree of tear and wear resistance

Applications:

- Wipe and maintenance of mechanical equipments
- General workplace maintenance and cleaning
- Suitable for lighter oil pollution environment
- For user own wipe
- **MOQ: 1 box**



Order Code	Size/sheet (mm)	No. of sheets/roll (box)	No. of layers	Surface texture	Colour	Package style	Pack qty	Price RM
-00003R	250 x 350	500	Single layer	Plain	Blue	Roll pack	2 rolls/ctn	486.00
-00001A	300 x 350	300	Single layer	Embossing	Blue	Sheet pack	6 boxes/ctn	1180.20

Heavy Duty Absorbent Pads

Product Features:

- Strong oil absorption, it can quickly absorb oil of 16 times its own weight
- Can be reused after washing

Applications:

- Control and absorb all kinds of oil leakage
- Absorb and clean up oil on the water surface
- Oil pollution control, clean up large areas of leaked oil
- Ships overhaul, boat bottom & ship board oil absorption
- Prevent industrial fields accidents and injuries caused by oil spills
- **MOQ: 1 box**

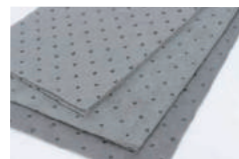

Order Code	Type	Size/sheet (mm)	Colour	Pcs/box	Price RM
-00200W	Oil-only roll (repels water)	400 x 500	White	200	578.80
-00400W	Maintenance roll (absorbs all fluids)	400 x 500	Gray	100	810.00

480Pc Stainless Steel Pan Head Machine Screw & Hex Nut Set

- A2-70 DIN7985
- Weight: 355g



Order Code	Price
TMFS80	RM
-01480K	68.00

Screw Range	Screw Quantity	Nut Range	Nut Quantity
M2 x 8	20	M2	80
M2 x 12	20		
M2 x 16	20		
M2 x 20	20		
M3 x 8	20	M3	80
M3 x 12	20		
M3 x 16	20		
M3 x 20	20		
M4 x 8	20	M4	80
M4 x 12	20		
M4 x 16	20		
M4 x 20	20		

400pc Stainless Steel Cap Screw & Hex Nut Set

- A2-70 DIN912
- Weight: 546g



Order Code	Price
TMFS80	RM
-03400K	82.00

Screw Range	Screw Quantity	Nut Range	Nut Quantity
M3 x 8	20	M3	80
M3 x 12	20		
M3 x 16	20		
M3 x 20	20		
M4 x 8	20	M4	80
M4 x 12	20		
M4 x 16	20		
M4 x 20	20		
M5 x 8	10	M5	40
M5 x 12	10		
M5 x 16	10		
M5 x 20	10		

180pc Stainless Steel Nyloc Nut Set

- A2-70 DIN7985
- Weight: 444g



Order Code	Price
TMFS80	RM
-02180K	78.00

Nut Range	Nut Quantity
M3	50
M4	40
M5	30
M6	30
M8	15
M10	10
M12	5

168pc Button Socket Cap Screw & Hex Nut Set - Grade 10.9 / Black

- Standard: ISO7380
- Weight: 288g



Order Code	Price
TMFS80	RM
-16168K	40.00

Screw Range	Screw Quantity	Nut Range	Nut Quantity
M3 x 6	10	M3	20
M3 x 10	10		
M3 x 12	10		
M3 x 16	10		
M4 x 8	10	M4	20
M4 x 12	10		
M4 x 16	10		
M4 x 20	10		
M5 x 10	8	M5	16
M5 x 14	8		
M5 x 18	8		
M5 x 25	8		

400pc Stainless Steel Machine Countersunk Screw & Hex Nut Set

- A2-70 DIN7991
- Weight: 436g



Order Code	Price
TMFS80	RM
-04400K	65.00

Screw Range	Screw Quantity	Nut Range	Nut Quantity
M3 x 8	20	M3	80
M3 x 12	20		
M3 x 16	20		
M3 x 20	20		
M4 x 8	20	M4	80
M4 x 12	20		
M4 x 16	20		
M4 x 20	20		
M5 x 8	10	M5	40
M5 x 12	10		
M5 x 16	10		
M5 x 20	10		

300pc Socket Set Screw Set - Grade 12.9 / Black

- Standard: ISO4029
- Weight: 188g

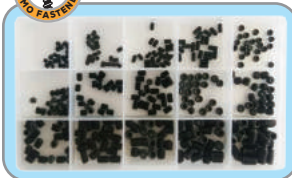

Order Code	Price
TMFS80	RM
-18300K	42.00

Screw Range	Screw Quantity
M3 x 3	20
M3 x 4	20
M3 x 5	20
M3 x 6	20
M4 x 3	20
M4 x 4	20
M4 x 5	20
M4 x 6	20
M5 x 4	20
M5 x 5	20
M5 x 6	20
M5 x 8	20
M6 x 6	20
M6 x 8	20
M6 x 10	20

300pc Stainless Steel Socket Set Screw Set

- Standard: DIN916
- Weight: 186g

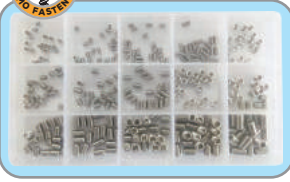

Screw Range	Screw Quantity
M3 x 3	20
M3 x 4	20
M3 x 5	20
M3 x 6	20
M4 x 3	20
M4 x 4	20
M4 x 5	20
M4 x 6	20
M5 x 4	20
M5 x 5	20
M5 x 6	20
M5 x 8	20
M6 x 6	20
M6 x 8	20
M6 x 10	20

Order Code	Price
TMFS80	RM
-06300K	65.00

400pc Stainless Steel Socket Button Head Machine Screw & Hex Nut Set

- A2-70 ISO7380
- Weight: 456g



Screw Range	Screw Quantity	Nut Range	Nut Quantity
M3 x 8	20	M3	80
M3 x 12	20		
M3 x 16	20		
M3 x 20	20	M4	80
M4 x 8	20		
M4 x 12	20		
M4 x 16	20		
M4 x 20	20	M5	40
M5 x 8	10		
M5 x 12	10		
M5 x 16	10		
M5 x 20	10		

Order Code	Price
TMFS80	RM
-05400K	78.00

440pc Socket Head Cap Screw & Nut Set - Grade 12.9 / Black

- Screw Standard: DIN912
- Nut Standard: DIN934
- Weight: 336g



Screw Range	Screw Quantity	Nut Range	Nut Quantity
M3 x 4	20	M3	220
M3 x 5	20		
M3 x 6	20		
M3 x 8	20		
M3 x 10	20		
M3 x 12	20		
M3 x 14	20		
M3 x 16	20		
M3 x 18	20		
M3 x 20	20		
M3 x 25	20		

Order Code	Price
TMFS80	RM
-17440K	72.00

242pc ZP Hex Nut Set

- Standard: DIN934
- Weight: 744g



Nut Range	Nut Quantity
M5	100
M6	80
M8	35
M10	15
M12	12

Order Code	Price
TMFS80	RM
-10242K	55.00

140Pc Stainless Steel Split Cotton Pin Set

- Standard: DIN94 (ISO1234)
- Weight: 220g



Range(mm)	Quantity	Range(mm)	Quantity
2 x 12	10	2.5 x 25	10
2 x 16	10	2.5 x 30	10
2 x 20	10	3 x 25	10
2 x 30	10	3 x 30	10
2.5 x 12	10	4 x 20	10
2.5 x 16	10	4 x 25	10
2.5 x 20	10	4 x 30	10

Order Code	Price
TMFS80	RM
-07140K	65.00

150pc Stainless Steel Internal Circilp Set

- Standard: DIN472
- Weight: 180g



Range(mm)	Quantity	Range(mm)	Quantity
9	10	19	10
10	10	20	10
12	10	22	10
14	10	24	10
15	10	25	10
16	10	26	10
17	10	28	10
18	10		

Order Code	Price
TMFS80	RM
-09150K	71.00

225pc Stainless Steel External Circilp Set

- Standard: DIN471
- Weight: 166g



Range(mm)	Quantity	Range(mm)	Quantity
3	20	12	15
4	20	15	15
5	20	16	10
6	20	17	10
8	20	20	10
9	15	22	10
10	15	25	10
11	15		

Order Code	Price
TMFS80	RM
-08225K	72.00

175pc Internal Circlip Set

- Standard: DIN472
- Weight: 134g



Order Code	Price
TMFS80	RM
-20175K	45.00

Range(mm)	Quantity
6	15
8	15
9	15
10	15
11	15
12	10
13	10
14	10
15	10
16	10
17	10
18	10
20	10
22	10
25	10

175pc External Circlip Set

- Standard: DIN471
- Weight: 160g



Order Code	Price
TMFS80	RM
-19175K	46.00

Range(mm)	Quantity
5	15
6	15
8	15
9	15
10	15
11	10
12	10
13	10
14	10
15	10
16	10
17	10
20	10
22	10
25	10

168pc Socket Head Countersunk Screw & Hex Nut Set - Grade 10.9 / Black

- Countersunk Screw Standard: DIN7991
- Nut Standard: DIN934
- Weight: 261g



Order Code	Price
TMFS80	RM
-15168K	45.00

Screw Range	Screw Quantity	Nut Range	Nut Quantity
M3 x 8	10	M3	20
M3 x 10	10		
M3 x 12	10		
M3 x 16	10		
M4 x 10	10	M4	20
M4 x 12	10		
M4 x 16	10		
M4 x 20	10		
M5 x 12	8	M5	16
M5 x 16	8		
M5 x 20	8		
M5 x 25	8		

280pc ZP Nyloc Nut Set

- Standard: DIN985 • Weight: 1510g



Order Code	Price
TMFS80	RM
-12280K	95.00

Nut Range	Nut Quantity
M5	100
M6	80
M8	40
M10	20
M12	20
M14	10
M16	10

440pc ZP Plain Washer Set

- Standard: DIN125 • Weight: 572g



Order Code	Price
TMFS80	RM
-11440K	48.00

Range	Quantity
M5	200
M6	100
M8	80
M10	30
M12	30

200pc Expansion & Compression Spring Set

- Including "tension spring" and "compression spring"



Order Code	Price
TMFS80	RM
-13200K	98.00

tension Spring Range(mm)	tension Spring Quantity	compression Spring Range(mm)	compression Spring Quantity
4.0 x 79.5	12	5.5 x 17.0	10
4.5 x 44.5	8	5.5 x 38.0	10
5.0 x 20.5	10	6.5 x 10.0	10
5.5 x 25.5	10	7.0 x 12.5	10
6.5 x 22.0	10	7.0 x 19.0	10
7.0 x 38.0	10	9.0 x 35.0	8
7.0 x 51.0	12	9.5 x 16.0	6
8.0 x 28.5	8	9.5 x 19.0	12
8.0 x 31.5	10		
8.0 x 44.5	12		
8.5 x 36.5	10		
8.5 x 47.0	12		

250pc Silicone O Ring Set

- Standard: DISO3601 • Weight: 90g



Order Code	Price
TMFS80	RM
-14250K	52.00

Range(mm)	Quantity	Range(mm)	Quantity
4 x 1	20	14 x 2	20
6 x 2	20	15 x 2	20
8 x 2	20	16 x 2	10
9 x 2	20	17 x 2	10
10 x 2	20	20 x 2	10
11 x 2	20	25 x 2	10
12 x 2	20	30 x 2	10
13 x 2	20		

Webbing Slings

Endless Round

- Made of most versatile of the nylon materials . The benefit of this endless sling is the distribution of wear points which helps increase the longevity.
- These slings are easy to move and store while being adaptable to a variety of uses. Although highly resistant to alkalis, they should not be used in acidic conditions.
- Safety factor : 1:6
- All slings are manufactured in a certified CE and GS standards



Double Ply Flat Eye-Eye



Endless Round Sling		Double Ply Flat Eye-Eye		Colour	Working Length (M)	Capacity (kg)
Order Code	Price RM	Order Code	Price RM			
-01020R	62.40	-41020F	39.60	Purple	2.0	1000
-01030R	92.90	-41030F	53.80		3.0	
-01050R	153.50	-41050F	68.30		5.0	
-01080R	245.00	-41080F	89.50		8.0	
-02020R	87.80	-42020F	60.10	Green	2.0	2000
-02030R	130.80	-42030F	79.20		3.0	
-02050R	216.60	-42050F	103.70		5.0	
-02080R	345.60	-42080F	142.90		8.0	
-03020R	113.80	-43020F	89.20	Yellow	2.0	3000
-03030R	169.70	-43030F	115.90		3.0	
-03050R	281.00	-43050F	149.10		5.0	
-03080R	448.40	-43080F	225.50		8.0	
-03100R	560.00	-43100F	286.50		10.0	
-05020R	180.60	-45020F	151.00	Red	2.0	5000
-05030R	269.20	-45030F	176.40		3.0	
-05050R	446.10	-45050F	261.10		5.0	
-05080R	712.10	-45080F	392.80		8.0	
-05100R	889.20	-45100F	457.50		10.0	
-08020R	294.00	-48020F	275.60	Blue	2.0	8000
-08030R	438.60	-48030F	354.60		3.0	
-08050R	727.50	-48050F	481.90		5.0	
-08080R	1161.60	-48080F	675.70		8.0	
-08100R	1450.60	-48100F	787.40		10.0	
-10020R	347.70	-50020F	358.30	Orange	2.0	10000
-10030R	519.10	-50030F	529.20		3.0	
-10050R	860.90	-50050F	642.90		5.0	
-10080R	1374.60	-50080F	901.90		8.0	
-10100R	1716.90	-50100F	1181.90		10.0	

Wall Mounted Key Cabinets

- Made of heavy gauge precision thick steel materials with a powder coated finish for durability.
- Key lock box includes key rings, identification tags, and a key location chart
- Ideal for home, office, apartment complex, boat dealers, rental car agencies, car lots, body shops and more.
- This lock box for keys has a secure 3-digit combination lock and conventional key system with over 1,000 possible combinations provides security and convenience. You can simply change the code when needed.



Order Code	Key Capacity	Key / Lock Type	Dimensions H x W x D (mm)	Colour	Weight (kg)	Price RM
-01120A	20	key Lock	200 x 160 x75	White	0.78	76.40
-01220A	20	3 digits code	200 x 160 x75	White	0.78	79.80
-01128A	28	key Lock	250 x 200 x 75	White	1.00	110.50
-01228A	28	3 digits code	250 x 200 x 75	White	1.00	114.00
-01136A	36	key Lock	300 x 240 x 75	White	1.45	124.30
-01236A	36	3 digits code	300 x 240 x 75	White	1.45	124.30

Steel Jerry Cans

- Made out of high quality cold rolled steel, leak proof, safety lock on spout, anti-corrosive Coating on inside and outside
- Suitable for storing diesel , petrol , paraffin and motor oil.
- Lockable to vehicles mounting bracket with anti-vibration mounts ideal for 4 x4 trucks, motorbike and commercial vehicles.
- Superior design with EPA/CARB compliant spout
- Quick flow spout provides safe fuel storage & easy pouring where you want when you want
- Comply with UN certifications.



Order Code	Capacity (L)	Wall Thickness (mm)	Dimensions W x D x H (mm)	Weight (kg)	Price RM
-01005A	5	0.6	240 x 115 x 310	1.24	89.00
-01010A	10	0.8	290 x 125 x 400	2.30	125.00
-01020A	20	0.8	355 x 165 x 460	3.70	178.00

Metal Adjustable Spouts

Order Code	Length (mm)	Thickness (mm)	Suitable for	Weight (kg)	Price RM
-07001P	300	0.65	5L / 10L / 20L	0.23	55.00

Metal Brackets

Order Code	Dimensions W x D x H (mm)	Weight (kg)	Price RM
-07005P	395 x 22 x 500	2.80	114.10

Industrial Double Section Aluminum Ladders

- Aluminum Alloy
- 27cm spacing per step
- Maximum load 150kgs
- Safety buckle design
- Foldable



Order Code	Stretch Height (cm)	Number of Steps	Weight (kg)	Price RM
TMLD10				
-20006A	170 - 250	6 x 5	5.5	527.20

Aluminum Folding Ladders

- Aluminum Alloy
- 30cm spacing per step
- Maximum load 150kg



Order Code	Stretch Height (cm)	Number of Steps	Weight (kg)	Price RM
TMLD11				
-10004F	120 - 240	4 x 2	5.0	501.90
-10006F	180 - 360	6 x 2	7.0	751.60
-10008F	240 - 480	8 x 2	9.1	1006.20
-10010F	300 - 600	10 x 2	11.0	1255.90

General Purpose Aluminum Ladders

- Aluminum Alloy
- 25cm spacing per step
- Maximum load 150kg



Order Code	Open Size (cm)	Number of Steps	Weight (kg)	Price RM
TMLD11				
-10006A	138 - 148	6	3.5	363.70
-10106A	187 - 198	6	4.8	446.10
-10206A	233 - 248	6	5.8	581.90

Aluminum Step Stools

- Aluminum Alloy
- Maximum load 150kg



Order Code	Open Size (cm)	Number of Steps	Weight (kg)	Price RM
TMLD16				
-20202A	34.5 x 31 x 30.5	2 x 2	1.2	140.60
-20303A	57 x 37 x 42.5	3 x 3	1.8	194.00

Industrial 3-Section Aluminum Ladders

- Aluminum Alloy
- 29cm spacing per step
- Maximum load 150kg



Order Code	Stretch Height (cm)	Number of Steps	Weight (kg)	Price RM
TMLD10				
-30006A	175 - 407	6 x 3	9.6	884.90
-30008A	233 - 581	8 x 3	12.0	1175.90
-30012A	349 - 929	12 x 3	16.8	1750.50

Aluminum Platform Steps

- Aluminum Alloy
- 30cm spacing per step
- Maximum load 150kg



Order Code	Height (cm)	Number of Steps	Weight (kg)	Price RM
TMLD11				
-20104A	120	4 x 2	3.2	368.20
-20106A	180	6 x 2	4.7	552.20
-20108A	240	8 x 2	6.2	736.40
-20110A	300	10 x 2	7.8	920.40

Industrial Dual-purpose Aluminum Folding Ladders

- Aluminum Alloy
- 29cm spacing per step, maximum load 150kgs
- Safely locking joints
- Foldable

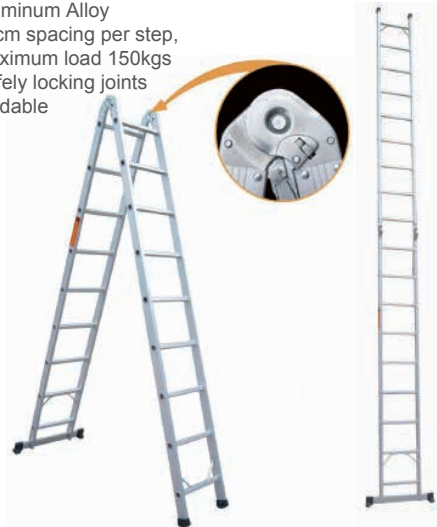

Order Code	Stretch Height (cm)	Number of Steps	Weight (kg)	Price RM
TMLD15				
-20005F	150 - 293	2 x 5	6.3	554.80
-20006F	180 - 353	2 x 6	7.0	570.80
-20007F	210 - 413	2 x 7	7.8	719.90
-20008F	240 - 473	2 x 8	8.6	758.80
-20009F	270 - 533	2 x 9	9.5	846.80
-20010F	300 - 593	2 x 10	10.4	1004.10

Industrial Multi-purpose Aluminum Folding Ladders

- Aluminum Alloy
- 29cm spacing per step
- Maximum load 150kgs
- Safely locking joints
- Foldable



Order Code TMLD15	Stretch Height (cm)	Number of Steps	Weight (kg)	Price RM
-50002F	72 - 250	4 x 2	9.5	554.80
-50003F	101 - 370	4 x 3	11.2	626.60
-50004F	126 - 470	4 x 4	12.5	712.90

Aluminum Workbench

- Aluminum Alloy
- Maximum load 150kgs



Order Code TMLD16	Platform Size (cm)	Height (cm)	Number of Steps	Weight (kg)	Price RM
-10002B	89 x 30	53	2	4.2	484.90

Insulated Ladders

- The handrail is made of FRP insulation material
- The foot step is made of aluminum alloy
- Insulation voltage 35kV
- 33cm spacing per step
- Maximum load 150kg



Order Code TMLD20	Height (cm)	Number of Steps	Weight (kg)	Price RM
-21006N	200	6	6.8	509.10
-21009N	300	9	10.0	763.70
-21012N	400	12	13.6	1018.30
-21015N	500	15	17.0	1272.90
-21018N	600	18	20.4	1527.40

Insulated Double Section Ladders

- The handrail is made of FRP insulation material
- The foot step is made of aluminum alloy
- Insulation voltage 35kV
- 30cm spacing per step
- Maximum load 150kg
- EN131 certificate



Order Code TMLD20	Height (cm)	Number of Steps	Weight (kg)	Price RM
-22013N	275 - 400	13	14.0	1357.70
-22019N	380 - 600	19	21.0	2036.60
-22025N	480 - 800	25	28.0	2715.40
-22031N	580 - 1000	31	35.0	3394.30

Insulated Platform Steps

- The handrail is made of FRP insulation material
- The foot step is made of aluminum alloy
- Insulation voltage 35kV
- 30cm spacing per step
- Maximum load 150kg
- EN131 certificate



Order Code TMLD20	Height (cm)	Number of Steps	Weight (kg)	Price RM
-12004N	120	4 x 2	7.6	698.30
-12006N	180	6 x 2	11.2	1047.40
-12008N	240	8 x 2	15.0	1396.50
-12010N	300	10 x 2	19.0	1745.60

Powerlite Flashlights

Mini LED Super Bright Flashlight

- This is the best flashlight tool for outdoor activities, emergency, camping, hiking, fishing, walk the dog, cave exploring, bike, home use and car breakdowns.
- Aerospace aluminum construction body and impact resistance endure scratches.
- 4 lighting modes : High continuous lighting for 4 hours, medium continuous lighting 6 Hours, Strobe continuous lighting for 8 hours.
- LED Lamp Lifespan: 4 Hours ,Strong light 6 hours ,ordinary light 8 hours.
- IPX5 waterproof designed makes it suitable for extreme conditions indoors or outdoors.
- Battery : 1 x 18650



Order Code	Dimensions (mm)	Voltage (W)	Brightness (LM)	Beam Distance (M)	Weight (g)	Price RM
TMLT01						
-01155K	116 x 24 x 24	10	350	200 - 500	84	68.40

LED Super Bright Zoom Flashlight

- This is the best flashlight tool for outdoor activities, emergency, camping, hiking, fishing, walk the dog, cave exploring, bike, home use and car breakdowns.
- Aerospace aluminum construction body and impact resistance endure scratches, abrasions and corrosion. You can even run it over with a car and it will still work!
- 5 lighting modes : High , medium , weak, Strobe and SOS.
- High-power LED lamp makes it distinctive, its useful time is more than 100,000 hours
- IPX5 waterproof designed makes it suitable for extreme conditions indoors or outdoors.
- Adjustable focus for use in different zooming situations.
- Battery : 1 x 18650



Order Code	Dimensions (mm)	Voltage (W)	Brightness (LM)	Beam Distance (M)	Weight (g)	Price RM
TMLT01						
-01122K	153 x 43 x 32	12	800	500	292	109.80

LED Anti Violence Super Bright Flashlight

- This is the best flashlight tool for outdoor activities, emergency, camping, hiking, fishing, walk the dog, cave exploring, bike, home use and car breakdowns.
- Aerospace aluminum construction body and impact resistance endure scratches, abrasions and corrosion. You can even run it over with a car and it will still work!
- Strong , ordinary , Dimming , Strobe, SOS.
- High-power CREE lamp makes it distinctive.
- Ultra-long illumination range up to 200 meters.
- Suitable for self defense applications, specially-designed bezel meant for inflicting blunt force trauma on an attacker.
- Battery : 1 x 18650



Order Code	Dimensions (mm)	Voltage (W)	Brightness (LM)	Beam Distance (M)	Weight (g)	Price RM
TMLT01						
-01133K	248 x 53 x 27	10	800	300 - 500	272	92.90

LED Long Distance Illumination Powerlite - USB Charging

- This is the best flashlight tool for outdoor activities, emergency, camping, hiking, fishing, walk the dog, cave exploring, bike, home use and car breakdowns.
- Aerospace aluminum construction body and impact resistance endure scratches.
- 4 lighting modes : High , Medium, Strobe and SOS lighting.
- LED Lamp Lifespan: Strong light 3 hours.
- IPX6 waterproof designed makes it suitable for extreme conditions indoors or outdoors.
- Suitable for self defense applications, specially-designed bezel meant for inflicting blunt force trauma on an attacker.
- Ultra bright LED flashlight with high brightness and range brightern up to 200m2
- Battery : 1 x 18650 , 1 USB charger



Order Code	Dimensions (mm)	Voltage (W)	Brightness (LM)	Beam Distance (M)	Weight (g)	Price RM
TMLT01						
-01144K	157 x 37 x 29	15	800	800 - 1000	272	122.00

Super LED Rechargeable Torch

- The switch has two options of strong light and power saving light
- 4 lighting modes : High continuous lighting for 5 hours, medium continuous lighting 10 Hours.
- 100 Lumens Flashlight
- Ultra-long beam range up to 200 meters.
- Water and oil resistant
- Input power - 100-240V , 50Hz/60Hz.0.15A
- Battery life can be more than 500 cycles of charging
- Includes USB cable for charging



Order Code	Voltage (W)	Price RM
TMLT30	1	123.40
-01001A		

LED Swivel Head Work Light - USB Rechargeable

- This led work light is made of hard rubber, anti-sweat and anti-slip, foldable design
- 270 degree rotate provide multi-angle illumination, magnet base and hook make your hand free to do other things in the night.
- 2 lighting modes : High & medium
- Magnetic base&Swivel hook: Built-in super magnet, adsorb any iron products with fixed lighting,The bottom designed with a hook. Ability to hung.
- Suitable for self defense applications, specially-designed bezel meant for inflicting blunt force trauma on an attacker.
- Super bright increases lumen-output.
- Additional functions as power bank for cell phone usage.
- Build-in 18650 rechargeable battery
- Rechargeable by USB port supplied with USB cable.
- Specifications (Refer belows)



Order Code	Dimensions (mm)		Weight (g)	Price RM
	Folding Length	Overall Length		
TMLT40	150 x 48 x 39	275 x 48 x 39	247	148.00
-00106A				

10M/220V/60W Lead Lamps - Metal Cage

- Durability and Safety tested for the toughest situations
- Equipped with hanging hook with 10m cables.
- Ergonomic designed provides users with a comfortable grip.
- Rated for Up to a 60-Watt Incandescent Bulb -Not Included



Order Code	Input Voltage (V)	Voltage (W)	Cable Length (M)	Price RM
TMLT50	220	60	10	41.90
-01060A				

Pocket Type LED Work Light - USB Rechargeable

- This Pocket led work light is made of ABS plus professional aluminium design , anti-sweat and anti-slip, features pocket / clip for hand-free operation.
- High lumen flashlight LED bulb provides bright light
- Built-in super magnet, adsorb any iron products with fixed lighting.
- 120 degree rotate provide multi-angle illumination, magnet base make your hand free to do other things in the night.
- Build-in 18650 rechargeable battery
- Rechargeable by USB port supplied with USB cable.
- Specifications (Refer belows)



Order Code	Dimensions (mm)		Weight (g)	Price RM
	Folding Length	Overall Length		
TMLT40	200 x 40 x 25		117	77.80
-00102A				

LED Work Light - USB Rechargeable

- This powerful LED work light ideal for mechanic's, boating, camping, night fishing or as an emergency light for the home.
- Strong Magnet to attach to suitable metal surface; Use Hook to hang on the anyway to provide brightness.
- 2 Lighting modes
- High lumen flashlight LED bulb provides bright light
- Additional functions as power bank for cell phone usage.
- Build-in 18650 rechargeable battery
- Rechargeable by USB port supplied with USB cable.
- Specifications (Refer belows)



5W COB	400LM
3W LED	200LM
2.5 Hours	215g
3 Hours	USB

Order Code	Dimensions (mm)	Weight (g)	Price RM
TMLT40			
-00109A	185 x 60 x 32	215	124.20

LED White/Red Light Switchable Headlight - USB Rechargeable

- This powerful LED work light ideal for mechanic's, boating, camping, night fishing or as an emergency light for the home.
- High lumen flashlight LED bulb provides bright light
- Made of durable ABS material, water resistant on off witch easy to use even with tough weather.
- Build-in 1x 3.7V/ 12000mAH battery
- Has following Modes: White Flood-3 settings, High - Medium - Low - Strobe.
- Adjustable elastic band, easy to install on the mining cap or directly on the head
- All settings are interchangeable as far as pattern or how the light flows.
- Rechargeable by USB port supplied with USB cable.
- Specifications (Refer belows)



3W COB	100LM	4 Hours
72g	2.5 Hours	USB

Order Code	Dimensions (mm)	Weight (g)	Price RM
TMLT40			
-07103A	60x 40 x 35	72	71.60

LED White/Red Light Switchable & Infrared Headlight - 5 Modes

- This powerful LED work light ideal for mechanic's, boating, camping, night fishing or as an emergency light for the home.
 - Made of durable ABS material, water resistant on off witch easy to use even with tough weather.
- 5 Lighting Modes:
- COB LED -Super Bright
 - XPE- Ultra Bright
 - XPE- Ultra Bright & COB LED -Super Bright
 - COB LED -SOS, Super Bright
 - COB LED -Strobe, Super Bright
 - Build-in 1x 3.7V/ 12000mAH battery
 - Adjustable elastic band, easy to install on the mining cap or directly on the head
 - Rechargeable by USB port supplied with USB cable.
 - Specifications (Refer belows)

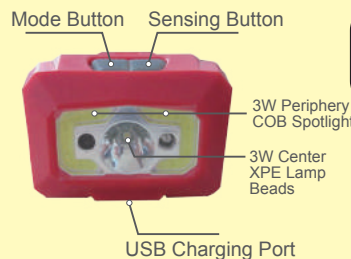

Irregular COB	3W XPE
4 Hours	2.5 Hours
140LM	140LM
74g	USB

Order Code	Dimensions (mm)	Weight (g)	Price RM
TMLT40			
-07104A	60 x 40 x 38	74	87.10

Wide Illuminating Induction LED Headlight

- Made of durable ABS material , needn't worry the dropping or shocking. Also,this headlamp is weather-proof , can use it even in the raining or snowing.
- SUPER-BRIGHT 10W CREE lamp bead
- Adjustable elastic band, easy to install on the mining cap or directly on the head
- Built-in auto sensor.
- 4 lighting modes : High , Medium, Strobe and SOS lighting.
- Rotated designed which make it ideal for indoors and outdoors to use.
- Build-in 2 x 18650 rechargeable battery
- Specifications (Refer belows)



Order Code	Dimensions (mm)	Beam Head Dimensions (mm)	Beam Distance (M)		Weight (g)	Price RM
TMLT40			Strong	Medium		
-07105A	190 x 90 x 82	82	500	400	262	142.70

AC Rechargeable LED Head Torch

- Environmental protection and energy saving 3WLED
- The switch has two options of strong light and power saving light
- Adjustable elastic band, easy to install on the mining cap or directly on the head
- Built-in high-capacity lithium battery
- Strong light continuous lighting for 10 hours, ordinary light continuous lighting 20 Hours
- Battery life can be more than 1000 cycles of charging



Order Code	High Mode Operating Time (h)	Ordinary Mode Operating Time (h)	Price RM
TMLT40			
-00001A	10	20	223.20

5W LED Rechargeable Powerful Spotlight

- Ultra bright LED, the switch has two options of strong light and power saving light
- Made of durable ABS material , needn't worry the dropping or shocking. Also,this headlamp is weather-proof , can use it even in the raining or snowing.
- IPX6 waterproof designed makes it suitable for extreme conditions indoors or outdoors.
- Low brightness light irradiation up to 8 hours.
- High brightness light irradiation up to 5 hours.
- SUPER-BRIGHT 10W CREE lamp bead with OSRAM lead.
- Build-in 1 x 18650 rechargeable battery
- Charging times : 5 - 6 hours



IPX45

Order Code	Dimensions (mm)	Beam Distance (M)	Voltage (W)	Brightness (LM)	Weight (g)	Price RM
TMLT20						
-00015B	155 x 100 x 70	200	5	350	264	108.30

Safety Spectacles - Anti-Laser

- Red resin lens, good anti-laser performance, anti-ultraviolet (UV)
- Impact resistance, scratch resistance, anti-fog
- Brow edging and side wing protection design, fully protects eyes from flying particles, provide comprehensive eye protection
- 4-section adjustable frame design suitable for various face types
- With a string hole, lightweight and convenient
- American Standard ANSI Z87. 1
- EU CE EN166F quality certification



Price / RM : 30.40

Order Code: **TMPP10-10001A**

Safety Spectacles - Passion Model

- Reinforced resin lenses, impact resistant, scratch resistant, anti-fog
- 8-position adjustable frame design suitable for various face types
- Super soft breathable rubber nose pads, more comfortable, suitable for long hour use
- Sports shape, dynamic fashion
- American Standard ANSI Z87.1
- EU CE EN166F quality certification



Price / RM : 31.30

Order Code: **TMPP10-10003A**

Safety Spectacles - Fieldwork Purpose

- Reinforced resin lenses, impact resistant, scratch resistant, anti-fog
- Brow edging and side wing protection design, fully protects eyes from flying particles, provide comprehensive eye protection, especially suitable for field wear.
- 4-section adjustable frame design suitable for various face types
- With a string hole, lightweight and convenient
- American Standard ANSI Z87.1
- EU CE EN166F quality certification



Price / RM : 37.00

Order Code: **TMPP10-10002A**

Safety Spectacles - Double Frames for Nearsighted

- Reinforced resin lenses, impact resistant, scratch resistant, anti-fog
- Double-frame design particularly for shortsighted user
- Easy to disassemble, changeable to large vision protective glasses
- Brow edging and side wing protection design, fully protects eyes from flying particles, provide comprehensive eye protection
- Super soft breathable rubber nose pads, more comfortable, suitable for long hour use
- 4-section adjustable frame design suitable for various face types
- With a string hole, lightweight and convenient
- American Standard ANSI Z87.1
- EU CE EN166F quality certification



Price / RM : 50.00

Order Code: **TMPP10-10004A**

Notes

A series of horizontal dotted lines for writing notes, spanning the width of the page below the title.